



TAMPEREEN TEKNILLINEN YLIOPISTO  
TAMPERE UNIVERSITY OF TECHNOLOGY

ZAHANGIR KHAN  
MANUFACTURING AND EVALUATION OF STRETCHABLE  
EMBROIDERED PASSIVE RFID TAGS ON 3D-PRINTED  
SUBSTRATES

Master of Science Thesis

Johanna Virkki, Academy Research  
Fellow, Biomedical Sciences and  
Engineering  
Doctoral Student Muhammad  
Rizwan, Biomedical Science and  
Engineering

Examiner and topic approved  
September 2017

## **ABSTRACT**

**Zahangir Khan**

Tampere University of technology

Master of Science Thesis, 47 pages, 00 Appendix pages

June 2018

Master's Degree Programme in Electrical Engineering

Major: Electronic Engineering

Examiners: Academic Research Fellow Johanna Virkki and Doctoral Student Muhammad Rizwan

**Keywords:** FDM Printing, substrates, RFID, tags

Stretchable electronics is an emerging field of electronics where the devices produced can undergo several mechanical stress conditions but maintain its structural integrity and electrical performance. Categorized under flexible electronics, it is still emerging as a new field of study where the flexible products produced are subjected to extreme mechanical conditions, like stretch and other mechanically induced stresses. It is envisioned that flexible and stretchable electronics will replace the traditional solid-state electronics that we are accustomed to in our everyday lives.

The challenges that lie ahead of flexible and stretchable electronics is the research and development of new materials that adhere to its requirements. Some new materials have already been developed and have been used commercially in a limited capacity, especially in the field of biomedical technology. Development of new materials, which usually involve adjustment of the physical and chemical properties of known materials to achieve the requirements of flexibility and stretch abilities, has been a challenging process.

This thesis is a study of one such material, known as NinjaFlex, a flexible material used for 3D printing, and is used for manufacturing products which are flexible. Using Fused Deposition Modelling (FDM) printing methods, flexible substrates were produced, upon which an antenna pattern was embroidered using conductive thread, and then a tag IC was attached on the matching part using conductive glue, hence developing passive Ultra High Frequency (UHF) Radio Frequency Identification (RFID) tags with different structural properties for observing their read ranges under stretch conditions.

Despite the challenges encountered during the development process, the tags performed well within the desired parameters. The tags responded to the reader's signal at optimal ranges. The tags, whose original length is of 14 cm each, responded to the reader at acceptable read ranges despite being subjected to stress causing its length to change by 2 cm.

Further improvements in the testing processes could be achieved if the tags are produced in a more automated process, and avoidance of signal affecting factors that resulted in the outcomes in this thesis.

## **PREFACE**

This Master's Thesis report on 'Manufacturing and evaluation of stretchable embroidered passive RFID tags on 3D-printed substrates' was completed under the partial requirements of completing the Master of Science Degree in Electrical Engineering, with the majors in Electronics Engineering. All the experiments and analysis were conducted in the Wireless Identification and Sensing Systems Research Group (WISE), supervised by Prof. Johanna Virkki and Doctoral student Muhammad Rizwan.

Firstly, I would like to thank Almighty God for His Mercy, Guidance and Grace. Then I would like my thesis supervisors for their efforts and guidance for helping me in completing the project. I would also like to thank Shubin Ma and Inari Lyyra for their assistance in the embroidery processes and the instructions for the stretching tests respectively.

I would also like to thank my parents Mr. Anwar Khan and Mrs. Jahanara Anwar, and my siblings Yasmeen Khan and Zaheer Khan for their immense patience during my completion of the master's degree. I would also take this opportunity to thank my friends M Sabbir Rahman, Shahriar Parvez, Mohammad Hossain, Tanvir Ahmed and Nabid Uz Zaman Bhuiya Faiem for their immense moral support, that helped me in completing this thesis.

Tampere, 29.06.2018

Zahangir Khan

## CONTENTS

1.	INTRODUCTION .....	1
2.	3D PRINTING .....	3
	2.1 Introduction .....	3
	2.2 The 3D printing process .....	3
	2.3 Printing materials .....	5
	2.4 FDM Infill density and percentage.....	7
	2.5 NinjaFlex.....	8
3.	RADIO FREQUENCY IDENTIFICATION (RFID) .....	9
	3.1 Introduction .....	9
	3.2 The RFID technology.....	9
	3.3 Frequency bands for RFID .....	10
	3.4 Components of the RFID System .....	11
	3.4.1 RFID tags .....	11
	3.4.2 Antennas.....	13
	3.4.3 RFID readers .....	14
	3.5 Embroidered tag antennas .....	15
	3.6 RFID design approaches .....	16
	3.7 Factors affecting signal propagation .....	17
4.	MECHANICAL PROPERTIES OF MATERIALS .....	19
	4.1 Introduction .....	19
	4.2 Stress and Strain .....	19
	4.3 Elastic and Plastic deformation .....	19
	4.4 Tensile test.....	20
5.	EXPERIMENTAL SETUP .....	22
	5.1 3D printing of the substrates .....	22
	5.2 Embroidering of the antenna pattern.....	23
	5.3 Antenna testing.....	25
	5.4 Stretching tests .....	28
6.	MEASUREMENT AND DISCUSSIONS.....	29
	6.1 Initial stretch tests.....	29
	6.2 Tag preparation and testing.....	31
	6.3 Microscopic observations.....	32
	6.4 Antenna Testing .....	34
	6.4.1 Anechoic testing.....	34
	6.4.2 Free space measurements.....	36
	6.4.3 Stretch tests .....	38
7.	CONCLUSIONS.....	43
8.	REFERENCES.....	44

## LIST OF FIGURES

<i>Figure 2-1 : FDM Processes a) Material Deposition b) building and support material production</i> .....	4
<i>Figure 2-2: Stereolithographic Process</i> .....	5
<i>Figure 2-3: SLS Process</i> .....	5
<i>Figure 2-4: Infill patterns a) rectilinear, b) hexagonal or honeycomb, c) line</i> .....	7
<i>Figure 2-5: Infill density expressed as a percentage</i> .....	8
<i>Figure 3-1: A typical RFID radio link</i> .....	10
<i>Figure 3-2: Active, semi-passive and active tags</i> .....	12
<i>Figure 3-3: Antenna beam width a) Polar plot (linear scale), b) rectangular plot (logarithmic scale)</i> .....	14
<i>Figure 3-4: Reflection and refraction principles</i> .....	18
<i>Figure 3-5: Reflection vs scattering</i> .....	18
<i>Figure 4-1: Uniform Stress acting over the body</i> .....	19
<i>Figure 4-2: Typical Tensile test specimen</i> .....	20
<i>Figure 4-3: Tensile test curve</i> .....	20
<i>Figure 5-1: Sample substrate</i> .....	22
<i>Figure 5-2: The antenna pattern with its dimensions</i> .....	23
<i>Figure 5-3: Husqvarna Viking machine</i> .....	23
<i>Figure 5-4: Substrate mounted on a white cloth and embroidered</i> .....	24
<i>Figure 5-5: The prepared tags, after the embroidery process and IC attachment</i> .....	25
<i>Figure 5-6: The Tagformance device</i> .....	26
<i>Figure 5-7: The Tagformance Pro's test cabinet</i> .....	27
<i>Figure 5-8: Inside view the Tagformance Pro's cabinet</i> .....	27
<i>Figure 5-9: Instron 4411 Tensile Strength Tester</i> .....	28
<i>Figure 6-1: Substrate setup on the Instron 4411 Tensile testing machine</i> .....	29
<i>Figure 6-2: Initial Stretch test outcomes</i> .....	30
<i>Figure 6-3: Formation of clusters at the bottom side of the substrate after embroidery</i> .....	31
<i>Figure 6-4: 25 % horizontal a) matching part b) substrate part</i> .....	32
<i>Figure 6-5: 25 % rectilinear a) matching part b) substrate part</i> .....	32
<i>Figure 6-6: 50 % horizontal a) matching part b) substrate part</i> .....	33
<i>Figure 6-7: 50 % rectilinear a) matching part b) substrate part</i> .....	33
<i>Figure 6-8: 75 % horizontal a) matching part b) substrate part</i> .....	33
<i>Figure 6-9: 75 % rectilinear a) matching part b) substrate part</i> .....	34
<i>Figure 6-10: Anechoic Chamber test outcomes for (a) 25 % tags, (b) 50 % tags and (c) 75 % tags</i> .....	35
<i>Figure 6-11: Free space measurements</i> .....	37
<i>Figure 6-12: 25 % horizontal tag response during stretch test</i> .....	38
<i>Figure 6-13: 25 % rectilinear tag response during stretch test</i> .....	39
<i>Figure 6-14: 50 % horizontal tag response during stretch test</i> .....	39

<i>Figure 6-15: 75 % horizontal tag response during stretch test</i> .....	40
<i>Figure 6-16: 75 % rectilinear tag response during stretch test</i> .....	40
<i>Figure 6-17: Final stretch test</i> .....	41

## LIST OF SYMBOLS AND ABBREVIATIONS

ABS	Acrylonitrile Butadiene Styrene
ASK	Amplitude Shift Keying
CAD	Computer Aided Design
EIRP	Effective Isotropic Radiated Power
EPC	Electronic Product Code
FDM	Fused Deposition Modelling
FSK	Frequency Shift Keying
IC	Integrated Circuit
PC	Polycarbonate
PE	Polyethene
PLA	Polylactic Acid
PS	Polystyrene
PSK	Phase Shift Keying
PVA	Polyvinyl Alcohol
RFID	Radio Frequency Identification Technology
SLA	Stereolithography
SLS	Selective Laser Sintering
SNR	Signal to Noise Ratio
UHF	Ultra High Frequency
$\sigma$	Stress
$Y$	Young's Modulus
$\epsilon$	Strain

# 1. INTRODUCTION

Fabrication of electronic devices on flexible substrates may have a wide array of applications in the electronics industry [1]. This approach of electronics manufacture is based on the development of electronics on substrates possessing some amount of flexibility. Significant successes have already been achieved in this regard in various applications like bendable displays, sensor skins for biomedical applications like implantable devices, flexible Radio Frequency Identification (RFID) tags, non-volatile memories, photovoltaics, soft robotics [1, 2]. However, there are still several challenges, one of them being the ability of circuits to perform around curved objects, instead of just mere bending abilities. Hence, achieving optimal stretch abilities would require the materials to sustain very high levels of strain, without compromising circuit integrity or performance [1]. Some of the most common materials currently in use for the manufacture of flexible electronics are organic semiconductors, nanoparticles, nanowires/tubes and 2D materials like graphene [3].

Although significant advances have been achieved the flexible aspects of flexible electronics, the study of stretch ability of flexible electronics is still in progress, where the flexible device is expected to perform under severe mechanical stress and strain conditions [4]. Stretch ability is relatively a more challenging aspect than flexibility [5].

Stretchable electronics are expected to be placed under curved conditions or in applications where simple flexibility may not be the only option. They are expected to perform under extreme stress conditions, especially with strain values much higher than 1%, without compromising its structural integrity, mechanical stability or electrical performance [1, 5].

In this thesis, several passive Ultra High Frequency (UHF) RFID tags were manufactured by developing a substrate, made by using Fused Deposition Modelling (FDM) 3D printing method, with NinjaFlex as the printing material, and then embroidering an antenna pattern on the substrate. The tags' performance was evaluated under stress conditions, where the limits of mechanical stress in which the tags performed optimally was observed.

This thesis encompasses the ideas of passive UHF RFID technology, FDM manufacturing process and one tensile testing method. Chapter 2 will cover the fundamentals of 3D printing, whereas Chapter 3 will present the basics of RFID technology and Chapter 4 will present the mechanical properties of materials briefly.

Chapter 5 will present the various equipment and their associated methods used for the development of the tags, consisting of the FDM printing method used, the type of tag substrates prepared, the development of the antenna pattern using embroidery, and the tensile testing machine used for the stretch tests.



Chapter 6 will discuss the measurement readings obtained, and the possible explanations of the outcomes. Chapter 7 will conclude the thesis topic and provide some suggestions about improvements of the challenges encountered during the working of this thesis.

## 2. 3D PRINTING

### 2.1 Introduction

3D printing is a revolutionary technology used for product development processes, from the design to its manufacture. 3D printing is used for manufacturing early models for verification and testing and helps in reducing time spent for the development of products [6].

Initially used for prototyping, 3D printing has come a long way since the 1980s for rapid prototyping, and with today's materials and technology, 3D printing has proven to be advantageous in industry, from initial design implementations to final product assessment. It also helps in minimizing the time spent in the development processes, the costs involved, logistics among many others [6].

3D printing is applied in a wide variety of applications, especially in the manufacture of prototypes in the industrial sector. Some of the specific applications of 3D printing are the following:

- Educational purposes, which may comprise of the development of conceptual models and functional prototypes.
- Product development in industries, consisting of a series of steps, some of which may include preliminary design, analysis of the design and optimization, manufacture of the prototypes, and final observations.
- Aerospace Industry, where jet engine prototypes and on demand parts can be manufactured.
- A widespread application in biomedical industry, where use of 3D printing in the development of biocompatible implants, prosthetics, drug delivery systems, and even artificial organs and tissues have already found its uses [6].

### 2.2 The 3D printing process

There are several 3D printers available in the market, and many of them have some unique properties regarding the manufacturing processes they use. However, the initial processes used for the manufacturing is common in almost all 3D printers, and they are:

1. Development or design of a 3D model using a Computer Aided Design (CAD) software
2. Conversion of the CAD file into a STL file
3. Conversion of the STL file into several 2D layers
4. Printing the 2D layers until the whole 3D image is printed
5. Cleaning and checking the final product

The CAD software is a tool to design the 3D model of the prototype to be printed. This 3D model is then converted into an STL file, which basically substitutes the 3D model's surfaces as planar

triangles and is known to efficiently represent all the surfaces of the 3D model. The STL file is then converted into a file with several 2D layers of the 3D image, and this process is commonly known as ‘slicing’ the file [6].

Although various printers adopt various kinds of methods for the printing processes, the most commonly used methods are Stereolithography (SLA), selective laser sintering (SLS) and FDM [6].

- FDM Process: In the Fused Deposition Modelling process, the material used for the printing process is placed in the extruder and heated to a temperature to convert the solid material into a molten state. The temperature is controlled, and the molten material is extruded on the print bed. The material then solidifies when it cools down and hardens, the rate at which it solidifies depends on the material. In this manner, the layer is produced, and the next layer is produced on top of the previous layer. This process continues until the product is completely printed, layer by layer [6-8].

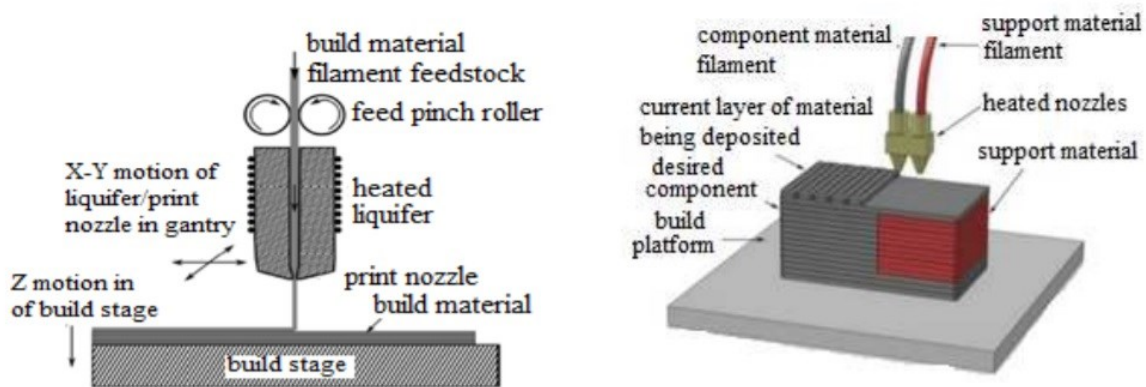

Figure 2-1 : FDM Processes a) Material Deposition b) building and support material production[8]

FDM process was the process used for the development of the tag’s substrate for the purposes of this thesis, and hence, 3D printing will be henceforth referred to as FDM in this report.

- SLA Process: Also known as the stereolithography, it is a process where a photoresist curable liquid resin is exposed to a laser beam. In this process, the photosensitive polymer is used as a material to build the 3D design, which solidifies when exposed to ultraviolet (UV) light, otherwise remaining in a liquid state. The platform or print bed of the 3D printer elevates upon completion of the layer, and as the UV light solidifies a layer, the platform raises and further liquid resin is added and the whole process is repeated again until the final product is completed [6, 9].

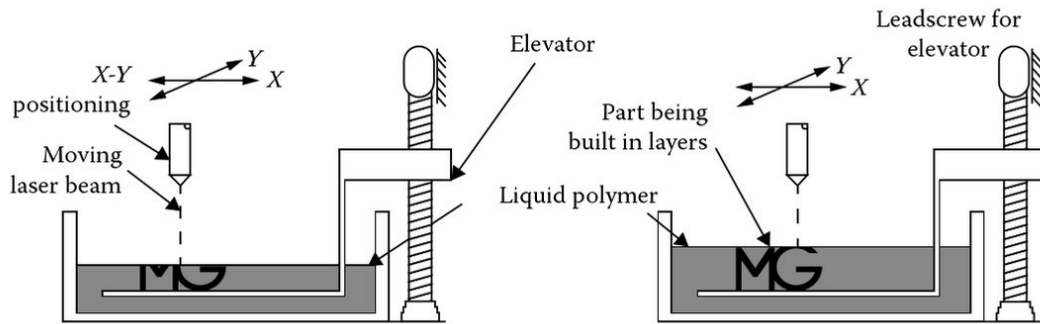

Figure 2-2: Stereolithographic Process [6]

- SLS Process: Also known as Selective Laser Sintering, this process involves the usage of powdered thermoplastic as the raw material, which is heated to just below its melting point. A laser beam is then used to fuse the powdered materials together in a fashion demanded by the design. As the layer's sintering process is complete, fresh powder is then deposited and the process is repeated until the design is produced [6].

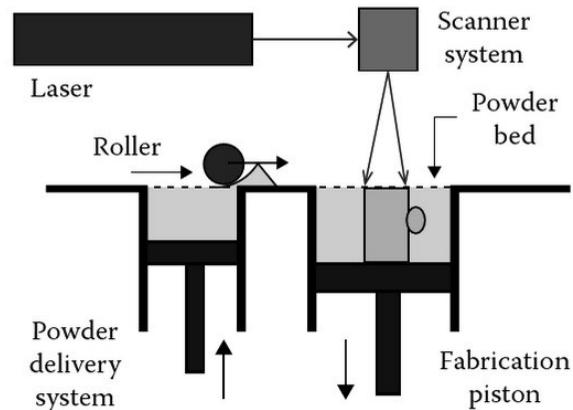

Figure 2-3: SLS Process [6]

## 2.3 Printing materials

There are several factors that are taken into consideration before selecting a material for FDM. These factors include the kind of application that the material is expected to perform, the function of the material in the application, including endurances that the application may require the material to perform, the geometrical structure required by the application and the ease at which the material can be used to achieve such a geometry, and postprocessing methods, if required, for optimal performance.

The most commonly used FDM material are polymers. Some of their properties, like low-electrical conductivity, higher ratio of strength-weight, ease of processing at relatively lower temperatures, high chemical corrosion resistance etc. are some of the advantages that polymers provide to enable easier 3D printing [6].

Polymers are subdivided into 3 subcategories, which are:

- **Thermoplastic Polymers:** One of the most common class of polymers used primarily in FDM processes, thermoplastic polymers are preferred for their ability to withstand several heating and cooling cycles, without significant molecular structure changes. Some common thermoplastic polymers are polylactic acid (PLA), acrylonitrile butadiene styrene (ABS), polycarbonate (PC), polyamides (nylon), polyvinyl alcohol (PVA), polystyrene (PS) and polyethylene (PE) [6, 10].
- **Thermosetting Polymers:** They transform into a rigid structure after cooling from a molten reheated state, however, once solidified, thermosetting polymers cannot be reshaped by thermal treatment, but some of them are reshaped using non-thermal methods. Post solidification, thermosetting plastics become brittle, and highly heat resistant, hence making it suitable for manufacturing products that require high mechanical and thermal tolerances [6].
- **Elastomers:** Elastomers are elastic polymers that are both flexible and stretchable. These qualities of elastomers make them suitable for a very wide variety of applications. Common elastomers include polyurethane, silicones, neoprene etc. [6].

As mentioned above, some of the most commonly used thermoplastic polymers are:

- **PLA:** An environmental friendly and biodegradable polymer, PLAs does not possess a very high melting point, but is quite brittle upon solidification. Ease of acquisition of this material, which is available in sugar plants like tapioca and sugarcane, and its relatively lower melting point makes it suitable for common use [6, 10]
- **ABS:** Known for a melting point higher than PLA, ABS can be used with relative ease as its molten state easily passes the extruder with lesser friction, and hence, used in widespread industrial applications. However, ABS shrink upon cooling, and it is because of this, a special heat bed is required to keep the ABS warm enough so that it doesn't shrink upon cooling. It is not very environmental friendly, as they produce airborne microscopic particles and mild odor upon extrusion, which may be harmful for humans and animals within its vicinity [6]. On the other hand, ABS is relatively more durable than PLA and can tolerate higher temperatures [10].
- **PC:** PC plastics have widespread applications in the manufacture of CDs, DVDs etc. and is also used in automotive and aerospace industries. However, its high extrusion temperature makes it difficult for 3D printing, and it also creates microscopic voids between the layers of the finished prototype, hence making it less strong than desired. UV rays also affects its physical properties, causing it to become brittle and opaque [6].
- **Polyamides:** Some of the advantages of nylon over ABS and PLA is that it is flexible and has a very strong bonding between its layers, and the layers adhere to each other more

strongly. One other advantage is that it is more resistant to acetone, which PLA and ABS aren't. However, extrusion temperature is relatively high [6].

- Thermoplastic Elastomer (TPE): Since elastomers are flexible, TPEs can be used for the development of flexible objects, like phone cases. It is relatively softer than rubber and can be used to produce objects in a short time [10].

NinjaFlex, which is a Thermoplastic Polyurethane (TPU), is categorized within the TPE family of materials [11-13], and was the material used for the FDM development of the substrates in this thesis. In Section 2.5, further details about NinjaFlex would be provided.

## 2.4 FDM Infill density and percentage

The physical properties of the object that is FDM printed depends on a wide variety of adjustable parameters, some of which are the individual layer's thickness, extrusion temperature and speed, infill percentage and its pattern used. The layer thickness is generally considered to be standardized at 100  $\mu\text{m}$  for most commonly used 3D printers [13].

Solid layers, especially on the top and bottom of the material to be printed, helps in maintaining the structural integrity of the printed object [14]. Usually the outer solid layer comprises of 100% infill, with a rectilinear pattern, to avoid surface roughness and porosity [13].

Infills refer to the way the interior of the object is printed. Infills of the object can be printed in various patterns. Some of the most common patterns used for FDM are the rectilinear pattern, the honeycomb pattern and the line pattern. Figure 2-4 illustrates the various patterns printed at 10% density [14].

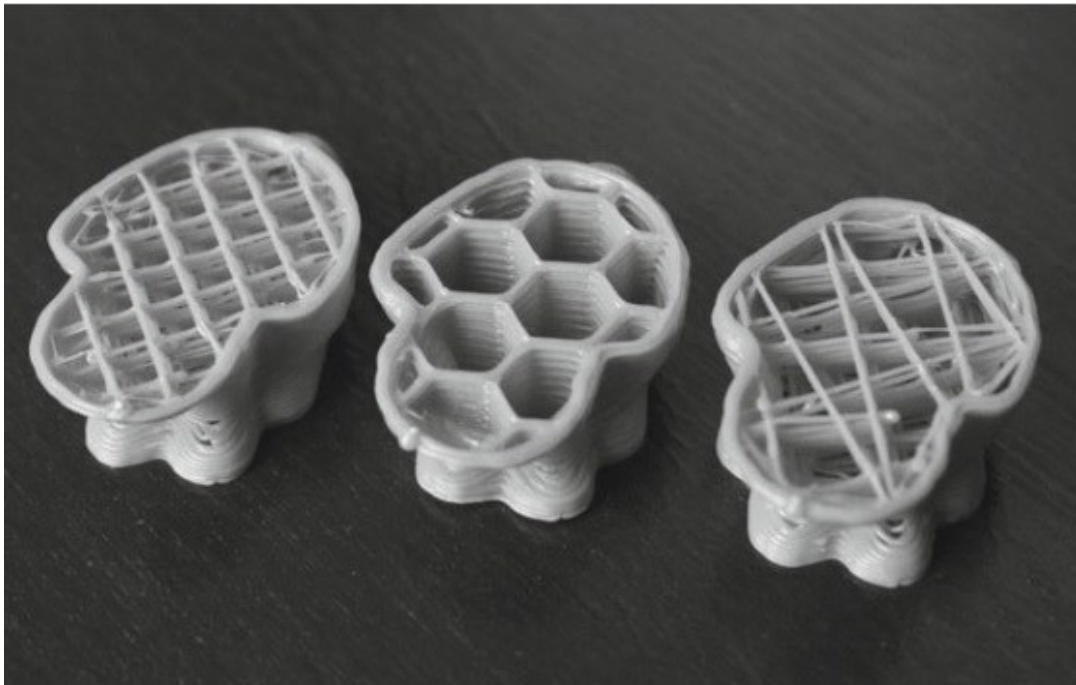

Figure 2-4: Infill patterns a) rectilinear, b) hexagonal or honeycomb, c) line [14]

Infill density refers to the amount of material that is used to achieve the above patterns, and hence the amount of space that will remain occupied within the object. Hence, the infill density affects the density of the object, its mechanical and possibly, its electrical properties [13]. Figure 2-5 below depicts the various infill percentages of a substrate printed in the rectilinear pattern.

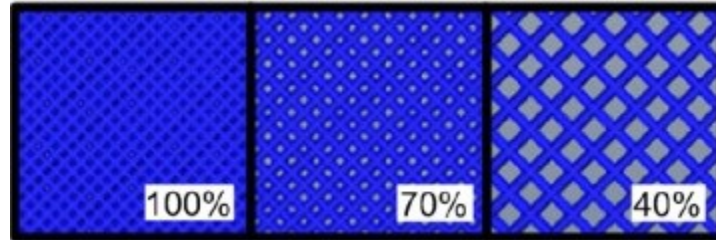

Figure 2-5: Infill density expressed as a percentage [13].

## 2.5 NinjaFlex

Ninjabflex is known as a TPU material [11], under the family of TPE materials [13]. Although it is commonly used as a material for FDM, it can be used for SLA and SLS [15]. Since it is flexible, elastic yet possesses high strength, it is used for manufacturing prototypes requiring flexible properties. It is primarily used for the manufacture of wearable wristbands, stoppers, insulation products, customized phone covers etc. [11, 15], but in recent studies, NinjaFlex was used for the manufacture of flexible antennas [16, 17].

Some of the parameters or printer settings required for optimal printing of NinjaFlex material is that the extruder temperature should be maintained within 225 °C to 235 °C, with the platform temperature being maintained at room temperature to 40 °C, the print speed for the top and bottom layers being maintained at 10-20 mm/sec, and the infill and shell speed be maintained at 15-35 mm/sec [18].

Some of the properties of NinjaFlex material are the following:

1. Shore hardness: 85A
2. Tensile Strength: 4 MPa (Yield), 26 MPa (Ultimate)
3. Elongation: 65 % of original length(Yield), 660 % of original length (Break)
4. Toughness: 82.7 Nm/m<sup>3\*106</sup> [18].

Ninjabflex is a relatively new material, introduced in 2014. Although it was not originally intended to be used for RF applications, the material was already tested by its use in the manufacture (by FDM methods) of an antenna and analyzing its electrical characteristics [13, 15, 17].

## **3. RADIO FREQUENCY IDENTIFICATION (RFID)**

### **3.1 Introduction**

Physical objects that we come to interact on an everyday basis requires some manner of identification, and this is done by our senses as we interact with them. However, for some applications like inventory and logistics management, mere reliance of human senses will not be enough. Hence, the need for identifying objects automatically using the help of technology resulted in the development of Automated Identification (Auto-ID) technologies. One of such methods was the use of bar codes, where the bar code is a specialized code imprinted on the object and are read by machines known as bar-code readers. Other methods include Optical Character Recognition (OCR), two-dimensional bar codes etc. The aforementioned optical technologies have some limitations, like requiring a line of sight, distortion of bar codes by external factors, like dust, ink, moisture, mishandling etc. can reduce the effective reading of the bar code, and hence, identification [19].

To overcome the shortcomings of Auto-ID technologies, RFID Technology emerged. RFID is a technology, which uses radio links for identification purposes of objects [19]. RFID technology is currently used in a wide variety of applications, such as security or tracking systems, contactless payments, management of supply chain, transportations etc.[20] .

It was during the decades of 1960s and 1970s where research into RFID technologies gained its momentum, although the first applications, in its very basic form, was during and soon after the Second World War. However, the first commercial application of RFID was achieved by 1960, and then gained momentum during the 1980s and 1990s, and recent advances were made possible due to the decrease in cost of silicon-based technologies, hence lowering the research and manufacturing costs [21].

### **3.2 The RFID technology**

A typical RFID system consists of an ‘interrogator’, or a reader, a tag, also known as the ‘transponder’, and several antennae to mediate the communication between the two. The reader antenna is either physically attached with the reader’s system or is connected via cables and kept separately from the reader’s body. The reader is usually connected to a host system, where the information received by or transmitted to the tag is stored and processed. The tag on the other hand, usually has an antenna with its system. A tag also usually consists of one or more silicon Integrated Circuits (ICs) [19].

When a link between the reader and tag is established, the flow of information constitutes the communication which happens by the radio link. In a typical operation, the reader sends the radio signal containing information to the tag, which captures the signal. The load impedance with the tag antenna (its adjoining circuitry, especially the silicon IC), modifies the signal and resends it



back to the reader, which the reader then receives and delivers to the host system for processing, and in some cases, storage of information. When the information is transmitted from the reader to the tag, this link is called the downlink, also known as the forward link. The tag, after modifying the reader's signal, sends it back, or more precisely, backscatters the modified signal back to the reader, and this link is called the uplink or the reverse link [19].

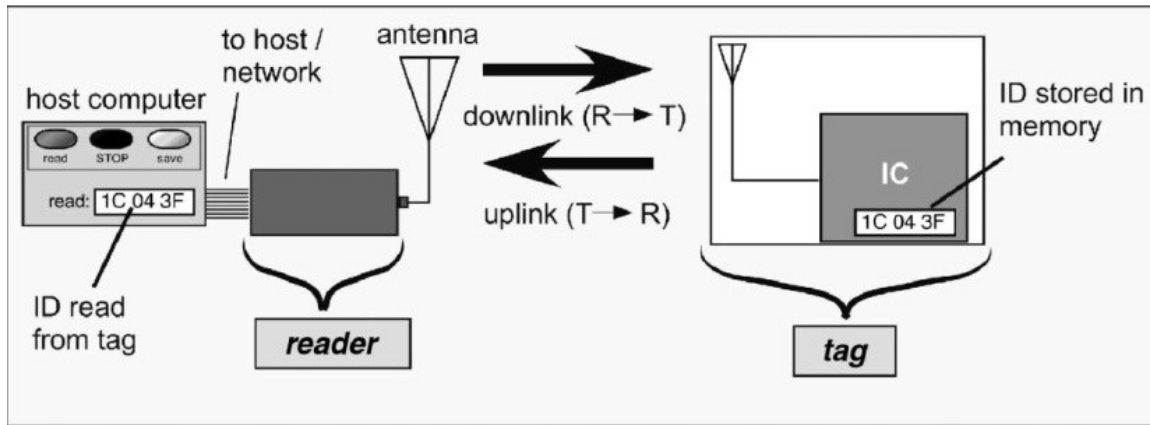

Figure 3-1: A typical RFID radio link [19]

The lack of the presence of a radio on the object that is being identified, instead using the backscattering method described above for communication between the reader and the object where the tag is attached, is called passive RFID communication [19].

### 3.3 Frequency bands for RFID

RFID systems are designed to operate within a wide range of frequency, usually from 100 KHz to 5GHz, but their operations are restricted within several narrow frequency spectrums. Some of the most commonly available bands for RFID operations are the 125/134 KHz band, the 13.56 MHz band, the 860-960 MHz band, and the 2.4-2.56 GHz band. The 125/134 KHz band is also known as the Low Frequency (LF) band, and the corresponding RFID system is known as LF RFID. The 13.56 MHz band is known as the High Frequency band, and the RFID system is known as HF RFID. The bands 860-960 MHz and 2.4-2.56 GHz are known as Ultra High Frequency (UHF) bands, and the corresponding RFID systems are known as UHF RFID system. However, to make a distinction, the 2.4-2.56 GHz UHF RFID system is usually referred to as microwave systems, whereas the system utilizing the 860-960 MHz band is commonly referred to as UHF RFID system [19]. The RFID system developed for this thesis is a passive UHF RFID system.

## 3.4 Components of the RFID System

### 3.4.1 RFID tags

Among the components, that comprises a typical RFID system, the tag, or transponder, is the component tracked by the reader. The tags usually comprise of a circuit with an IC attached to it, and the antenna, which receives the incoming signal from the reader [22].

The requirements that determine the type of tag and its design for use are the following:

- Frequency band
- Size requirements
- Read range
- Effective Isotropic Radiated Power (EIRP)
- The objects on which the tags are used
- Polarization (or orientation)
- Mobility
- Cost
- Reliability [23]

Based on power requirements, the tags are classified into three categories:

- **Passive tags:** This kind of tag has no power source of its own and relies on the power of the signal received from the reader. The antenna of this type of tag receives the RF signal, and its adjoining circuitry converts the power of the RF signal into DC, which it uses for powering the circuit and the IC within the tag. After its operation, the modified DC signal is converted into RF and backscattered back to the reader. The main advantages of passive tags are lower cost and a higher shelf life [19, 22]. However, some disadvantages include relatively low range since it requires the reader's signal for power; the tag must be relatively closer to the reader, lower computational ability due to limited power availability, and security and privacy issues [19].
- **Active tags:** This type of tag comprises of a power source and a radio system with a transmitter, receiver, local oscillator etc. within its setup, and hence, they communicate with readers by generating radio signals of their own. Some of its advantages are that they can communicate with the radio at long distances, and has computational capabilities, and hence, possess higher security and privacy features. Its main disadvantage are higher costs, larger size and a lower shelf life, which are dependent on several components contained within it [19].
- **Semi-passive tags:** A tag which consists of its own power source only, but communicates with the reader by modifying its RF signal [19, 22]. Its advantages are an increased range and better signal processing abilities relative to passive tags, but disadvantages include higher cost, size and lower shelf life [19].

The figure below is a diagrammatic representation of the three types of tags:

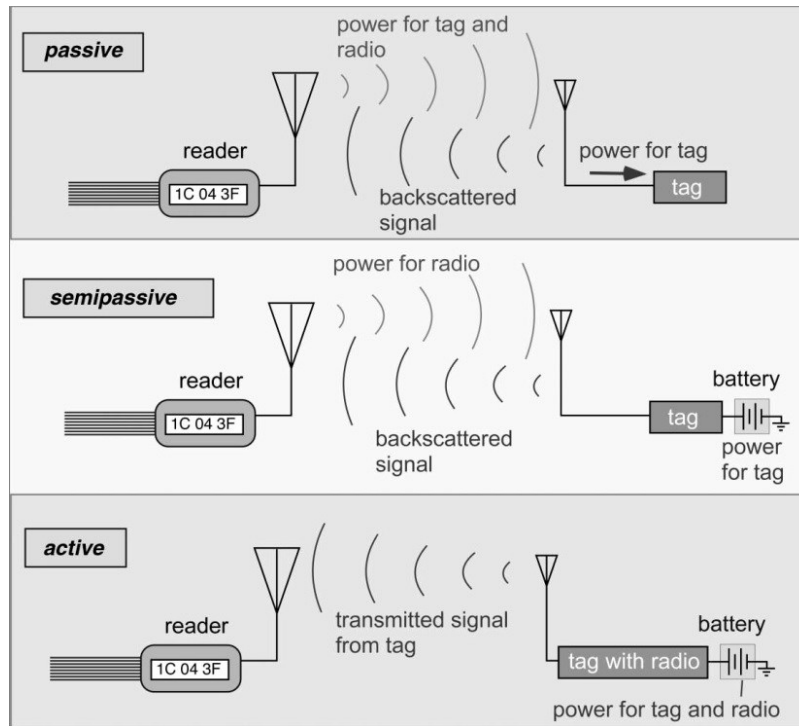

Figure 3-2: Active, semi-passive and active tags [19]

Tags are also classified on its ability to read/write data, and there are five classes, defined by Electronic Product Code (EPC Global). They are:

- Class 0: Known to be read-only tags, they are simple tags. They are preprogrammed by the manufacturer, who determines the program and the numbers on the tags [24].
- Class 1: Tags that can be written only once, either by the manufacturer or the user. Used in product identification and producing electronic ID badges [24].
- Class 2: Tags where data can be read and written, and can be done by the user, essentially several times [24].
- Class 3: These tags are also able to read and write, but also contains onboard sensors, like temperature, pressure sensors etc. The sensor's data is then recorded into the tag's memory. Since sensor data need not be recorded in the presence of a reader, the tag could be semi-passive or active tags [24].
- Class 4: Able to read and write, but also contain on board transmitters. Can communicate with other tags without the presence of a reader [22, 24].
- Class 5: Able to power Class 1,2 and 3 tags and maintain communication with Class 4 and each other[24].

For a passive UHF RFID system, the tag antenna delivers the power to the load connected to the antenna. For maximum power transfer, the antenna reactance and its load reactance must be matched. The tag antennas are variants of dipole type antennas. Usually, several methods are used to fit relatively larger antennas on the tags, and achieve matching, like bending the antenna wire to fit within the tag space, or using a shunt inductor at the two halves of the dipole, or adding an

extra conductor width at the ends of the dipole, but effectively reducing its resonant frequency, or rolling the dipole ends, resulting in increased source impedance [19].

### 3.4.2 Antennas

An antenna is a device that is used for transmitting or receiving electromagnetic waves. It does so by converting electrical current to electromagnetic waves when transmitting and vice versa when receiving [25].

As mentioned in section 3.2, antennas are an integral component in the setup of an RFID communication. Antennas are the main connecting link between the reader and the tag, which enables wireless communication. Hence, the appropriate selection of an antenna is of paramount importance. However, there are several performance factors that should be considered before the selection of an antenna, some of which are:

- **Radiation Pattern:** Displacement of charges, or accelerating charges is the cause of electromagnetic radiation. This electromagnetic radiation causes the antenna to emit radiation in all its sides, varying in intensity. Isotropic radiators are ideal antennas where the radiation pattern in all its sides are of equal intensity.

Fields of radiation depends upon the distance of the field of the radiation from the antenna. The ‘reactive near field’ region of the antenna signifies the field where the energy is returned to the antenna. Moving further ahead, is the ‘Fresnel near field’ region of the antenna where the radiation fields overcome the reactive fields, and the radiated field’s angular displacement depends on the distance from the antenna.

In the ‘far field’ region the radiating fields dominate, but the angular field distribution is independent of the distance from the antenna. In this region, the electric field vector and the magnetic field vector are perpendicular to each other, and the direction of observation [25].

- **Directivity:** It is the ratio of the maximum radiation intensity in a specific direction of a given antenna to the radiation intensity of an isotropic antenna over all the directions. Since the directivity of an isotropic antenna is considered to be unity, the maximum directivity by an antenna in a particular direction with respect to the isotropic reference antenna will always be greater than unity [26].

The definition of the gain of an antenna is relatively similar to the directivity, the only difference being that instead of the radiated power, the accepted power of the antenna is taken into account [25, 26].

- **Beam width:** The beam width specifies the shape of the area of maximum radiation in a direction, which signifies the main lobe of the antenna. The most commonly known beam width is the half lobe beam width where received or transmitted power is half of the

maximum received or transmitted power. First null beam width is the other type of beam width which is less commonly referred to [25].

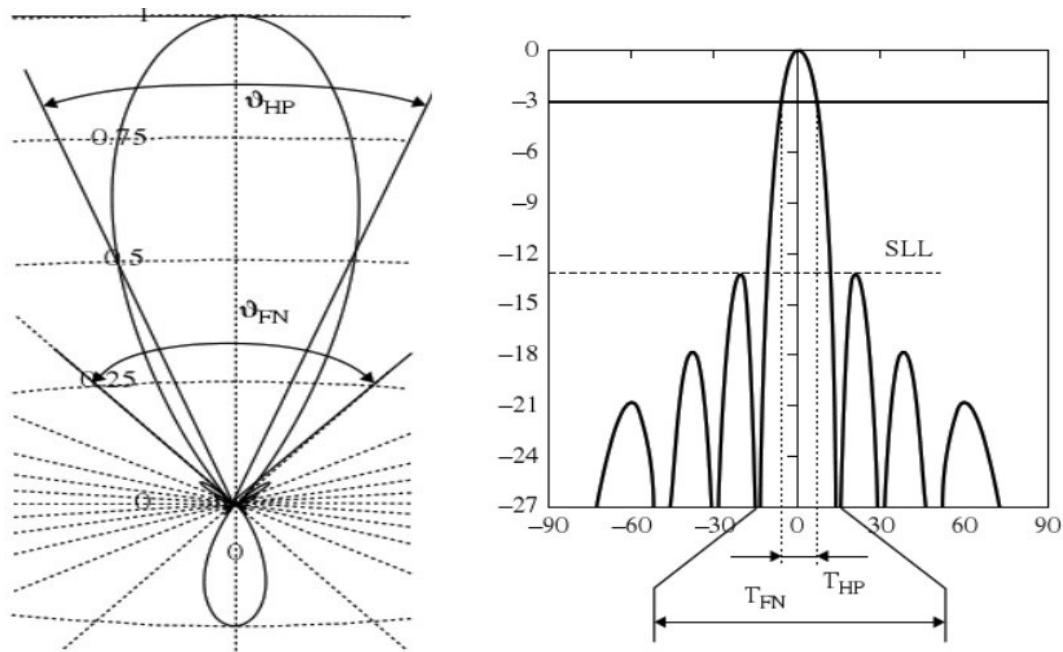

Figure 3-3: Antenna beam width a) Polar plot (linear scale), b) rectangular plot (logarithmic scale) [25]

- **Bandwidth:** The bandwidth of an antenna is a range of frequencies within which the antenna operates, and most of its characteristics is dependent on the bandwidth. It is usually considered the range of frequencies beyond the central frequency, where the antenna's operation remains optimal. At the central frequency, impedance matching is optimal, but on either side of the central frequency, the matching condition degrades [25, 26].
- **Polarization:** In the far-field region, two spherical components of the electric field of the antenna radiation will exist, with a phase difference between them. This phenomenon results in the antenna and the electric field being elliptically polarized. However, a phase difference of plus or minus  $90^\circ$ , with the amplitude remaining the same, results in circular polarization, whereas when the phase difference is  $0^\circ$  or  $180^\circ$ , the polarization is called linear polarization [25].

### 3.4.3 RFID readers

Readers are the devices that communicate with tags by a process known as 'interrogation'. Readers are usually connected to host computers too [23]. In a passive RFID system, the reader's RF signal is the source of DC power of the tag, and during this process, the communication is established. In an active RFID system, the active tag transmits its signal, where one or multiple readers receive the signal[19].

For sending and receiving data, readers are equipped with a transceiver, antennas, and a processor for decoding data [23]. RFID reader radios are also designed to perform some generic functions, which are amplification of smaller signals, oscillation or generation of signals of high frequencies, combining of several frequencies, also known as mixing, and filtering of wanted or unwanted signals [19].

Selection of an RFID reader is dependent on certain criterion which the reader must be able to fulfil in a given application, and some of the criterions are: its operating frequency, its ability to adapt to any given protocol, adherence to regulations depending on the region it is being used, ability to manage multiple antennas, network-host relationship, adapting to changing antenna conditions etc. [23].

Readers based on their applications, are classified into three types:

1. Fixed readers: They are used in locations where there is a significant movement of objects with tags attached to them within a specific zone or area. They are defined in a fixed position, and track the tags or objects passing through them [23].
2. Handheld readers: These readers are a significant advantage over fixed readers, where tags can be detected or monitored in any area of interest. Especially useful in loading or unloading operations to and from storage in inventory management and logistics, the handheld reader can be carried over wherever needed [23].
3. Mobile readers: This type of reader is used without the constant use of human intervention. These readers contain a self-tracking mechanism to detect tags and store or process information. Used in forklifts, conveyers, vehicles etc. It can be taken to the tag for detection, an advantage over fixed readers, and doesn't always need human intervention for information processing, a significant advantage over handheld readers [23].

### **3.5 Embroidered tag antennas**

Antenna patterns when embroidered onto non-conductive fabrics, can be of great potential use, especially in the manufacture of antennas on wearable clothes [27, 28]. Embroidery or sewing of antenna patterns by the use of conductive thread on non-conductive clothing could enable the development of tag antennas on fabrics for use in UHF RFID and can be user friendly too [28-30]. It may be useful for several applications, especially in the field of biomedical technology, where real time measurements of body temperature, heart rate, and other information can be obtained [31, 32]. However, use of wearable antennas on the human body may result in reduced radiation efficiency and impedance of the antenna. This occurs due to energy dissipation and high dielectric constants of the human body [27].

Section 5.2 indicates the antenna pattern (Figure 5-2) and the description of the embroidery process used for the development of UHF RFID tags antennas.

### 3.6 RFID design approaches

Two RFID design approaches that are different in their fundamental setup, for the transfer of data and power from the reader to the tag are commonly used. They are the electromagnetic wave capture (EM) and wave capture. Both these designs exploit the advantages of the RF antenna's EM properties, which are the near field and the far field RFID.

- Near field RFID: The basis of the near field communication is the Faraday's principle of electromagnetic induction. A resultant magnetic field is generated by the electric current flowing through the coils of the reader. This magnetic field induces an electric current in the coils of the tag's antenna. The number of turns in the tag antenna's coils is low. This electric current generated is used for powering the tag circuitry.

The near field communication employs load modulation technique for data transfer. The electric current flowing through the tag generates a magnetic field on its own, albeit a small magnetic field (due to the lesser number of turns). The reader detects this small magnetic field, when the tag is placed close to it, since it is opposite in direction to the reader's magnetic field [33].

- Far field RFID: These tags of this type of RFID capture the EM waves emitted from the reader's dipole antenna. A dipole antenna attached to the tag receives these waves as alternating voltage appearing across its arms. A diode attached to it can convert the alternating potential to direct current [33].

Far field tag antennas employ backscattering techniques to send the information back to the reader. An impedance mismatch between the tag and the reader results in the reader acquiring this difference as a power change and is received by the reader's radio. Changing the tag's impedance and frequency response can change the power of the signal backscattered to the reader [33].

Near field RFID is preferred for short distance communication, especially in the presence of metals or liquids, and hence suitable for relatively expensive, small and sensitive equipment. Far field RFID is preferred for longer distances communication but is affected by the presence of metals or liquids [34].

There are several factors that are to be considered to select an appropriate RFID system based on the applications that requires a system and performance expectations. Some of the factors that are to be considered are the read range, the modulation scheme, signal to noise ratio and the bandwidth available [35].

- Read Range: Read range is the maximum distance at which the reader and the tag communicates effectively. The higher the power of the signal transmitted by the reader, the further the tag can acquire the signal, and modify the signal. The higher the power of the signal backscattered by the tag, the easier it is for the reader to receive the modified signal.

However, interference and reader/tag sensitivity are the other factors affecting read range [35].

- Bandwidth available: The RFID system is highly dependent on the available bandwidth available for use, as the data rate and modulation scheme that can be used is directly dependent on it [35].
- Modulation scheme: Upon selection of an appropriate bandwidth, efficiency of the communication method depends on the modulation scheme used to transmit or receive information between the reader and tag. The most commonly used modulation techniques for passive RFID and some active RFID systems are Amplitude Shift Keying (ASK), because of its low cost and lower power requirements. However, some other modulation schemes like Frequency Shift Keying (FSK) or Phase Shift Keying (PSK) are also used [35].
- Signal to Noise Ratio (SNR): The SNR of the backscattered signal is directly dependent on the data rate of the communication process between the reader and the tag. Selection of a higher SNR is optimal as it results in increased range between the reader and tag, lower bit rate and higher bit rate's throughput [35].

Some of the other factors that are to be considered are the environmental conditions, the antenna's directivity, orientation and gain, the power and cost requirements among many other factors [35].

### **3.7 Factors affecting signal propagation**

A propagating signal, such as the signal from the reader to tag, can be affected by several environmental factors. Some of the factors are reflection, refraction, diffraction and scattering [36].

- **Reflection and refraction**: When a wave propagating in a medium encounters the surface of another medium, reflection or refraction takes place. In reflection, the signal completely bounces off, whereas in refraction, a part of the signal is absorbed by the medium it met. In several cases, both reflection and refraction occur, where a part of the signal is reflected, whereas the other part of the signal is refracted. Figure 3-4 below illustrates the reflection and refraction principle [36].



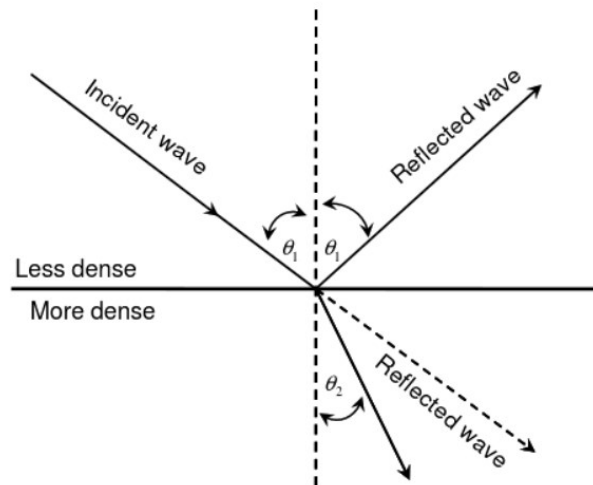

Figure 3-4: Reflection and refraction principles [36]

- Diffraction: A radio wave which can travel by bending around any obstacle, in its propagation path from the transmitter to receiver, is called a diffracted wave, and the process of bending of the wave around the obstacle is called diffraction [36].
- Scattering: When an incident wave encounters any surface with significant roughness, the waves scatter in random directions. A rough surface can be viewed as several separate surfaces on its own, and as the waves falls on its surface, several reflections occur, in various directions, hence, scattering the signal. Figure 3-5 below illustrates the difference between reflection on a smooth surface and scattering on a rough surface [36].

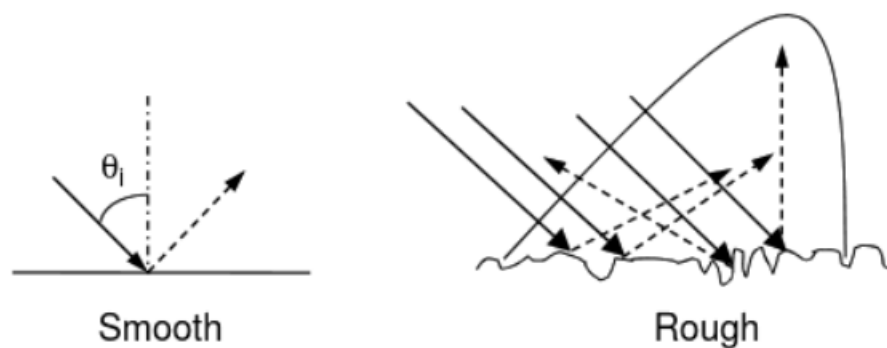

Figure 3-5: Reflection vs scattering [36].

## 4. MECHANICAL PROPERTIES OF MATERIALS

### 4.1 Introduction

The mechanical properties of materials are among the various properties taken into consideration when designing flexible and stretchable electronic circuits. Observing their structure and their deformations and point of fracture when sufficient force is applied is of key importance. The external forces must overcome interatomic forces holding the structure together to cause a deformation in the object. The deformations may be temporary or permanent [37].

### 4.2 Stress and Strain

The term stress refers to the forces acting upon a body, whereas the term strain refers to the deformations occurring due to the stress applied. Normal stress is the stress acting normally on a body, whereas shear stress is acting parallel to the body [38].

Stress is denoted by  $\sigma$ , and is defined as a force applied on a point in the object, hence

$$\delta\sigma = \delta P / \delta A$$

When the stress is uniform all over the body,

$$\sigma = P/A$$



Figure 4-1: Uniform Stress acting over the body [37]

Strain is denoted by  $\epsilon$  and is defined as the change in shape of the length of the body with respect to the total length, upon application of stress. Hence,

$$\delta\epsilon = \delta L/L$$

And integrating over its whole length, the total strain becomes,

$$\epsilon = \Delta L/L_0 \text{ [38]}$$

### 4.3 Elastic and Plastic deformation

Deformations may be of two types, depending upon the intensity of forces applied on the material. They are elastic and plastic deformations. The former is a type of deformation in which the material regains its original shape after the force applied is removed, when there was initially a deformation

when the same force was applied. The latter, on the other hand, results in the deformation becoming permanent, and even upon removing the force applied, the material does not regain its original shape [38].

#### 4.4 Tensile test

The tensile test is a means to test the load carrying capabilities of some materials [37]. Usually the samples are either cylindrical shaped or flattened dumbbell type specimens [37-39], as shown in figure 4-2 below.

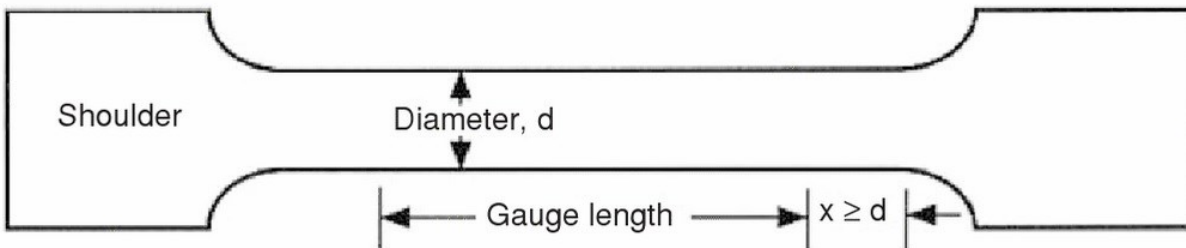

Figure 4-2: Typical Tensile test specimen [38]

The arms of the tensile test machine (which will be described later) grips the shoulder portion of the specimen, but the entirety of the stress is applied on the narrower portion of the sample.

Figure 4-3 represents a typical stress strain curve. When the stress applied is minimal, the material, upon removal of the stress, regains its original shape, and hence the resulting part of the curve is a straight line, indicating an elastic behavior. However, on application of higher stresses, the material does not regain its original shape as the stress is removed, and this results in permanent shape change, and a curved line on the graph, indicating the plastic region of the curve [37-39].

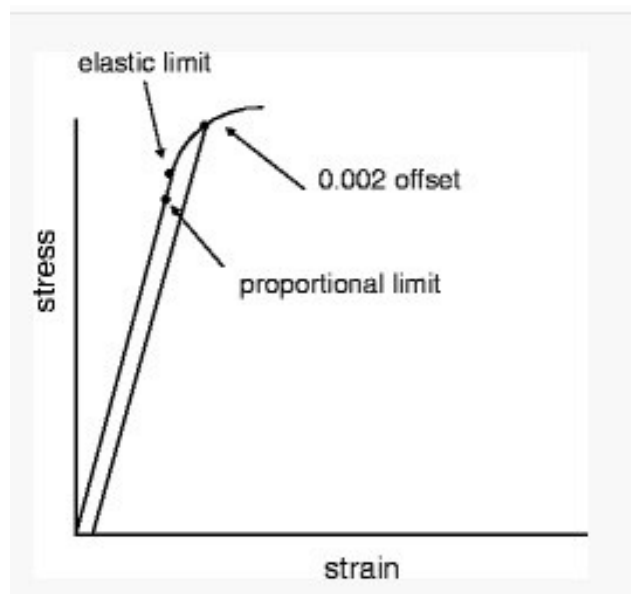

Figure 4-3: Tensile test curve [37]

The elastic behavior of the curve is presented by Hooke's Law, which is

$$\sigma = Y\epsilon$$

Where  $Y$  is, the Young's Modulus, and is characteristic of the material [37]. The stress is represented by  $\sigma$  and the strain due to the stress is represented by  $\epsilon$ .

Due to measurement accuracy concerns, the determination of an actual 'yield point', a point where a material stops being elastic and starts becoming plastic, cannot be readily determined. Hence, to overcome the problem, a straight line parallel to the elastic line of the curve is drawn, but additionally keeping an offset of 0.2%. The point at which this line intersects at the curve is taken as the 'yield point' [38].

## 5. EXPERIMENTAL SETUP

This section will present the set of procedures and the equipment used for the manufacture of RFID tags, the development of the antenna pattern and IC attachment on the finished tags.

### 5.1 3D printing of the substrates

The 3D printer used for the printing of the tags was Prenta Duo 3D Printer. It is a double nozzle printer with a transparent casing. It is capable of printing at speeds up to 250 mm/s. It uses an Arduino Mega2650 platform with an open source firmware called Repetier [40].

The printing of the substrates was conducted by Prenta Oy, the manufacturers of the Prenta Duo XL Printer. The material used for the manufacture of the substrate was ‘NinjaFlex’. Several samples were produced, where all of them were of 1mm thickness, and 140 mmx 20 mm rectangular samples. The samples produced were

- 25 % infill density, with a rectilinear pattern
- 25 % infill density, with a horizontal pattern
- 50 % infill density, with a rectilinear pattern
- 50 % infill density, with a horizontal pattern
- 75 % infill density, with a rectilinear pattern
- 75 % infill density, with a horizontal pattern

Based on the information provided by Prenta Oy company, the printing was done using the Prenta Duo 3D printer, with a nozzle temperature of 230-235 degrees centigrade and with a printing speed of 35 mm/sec. The individual layers of the print were of 0.2 mm, with 2 solid 100 % rectilinear layers for the top and bottom layers each, to maintain stability of the print process and the finished product as a whole. Figure 5-1 below depicts the final printed sample of one of the substrates.



*Figure 5-1: Sample substrate*

### 5.2 Embroidering of the antenna pattern

A predetermined antenna pattern was embroidered on the FDM printed substrates. Figure 5-2 below shows the antenna pattern used for the embroidery process.

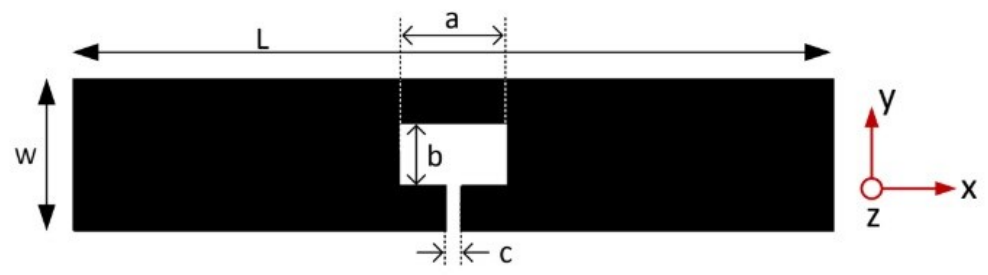

Geometrical parameters in millimeters.

a	b	c	W	L
14.3	8.13	2	20	100

Figure 5-2: The antenna pattern with its dimensions [27, 30]

The antenna pattern was embroidered using the Husqvarna Viking Royale Ruby Embroidery machine, as shown in Figure 5-3 below [41].



Figure 5-3: Husqvarna Viking machine

The thread that was used for the embroidery process was a conductive yarn, Shieldex multifilament thread 110f34 2-ply HC, whose DC linear resistivity is  $500 \pm 100 \Omega$ , and with an approximate diameter of 0.16 mm. The steps of the embroidery process were as follows:

- Initially the substrate was sewn manually on a thick piece of cloth, for support purposes, as the substrate's dimensions would not fit the already available frames for embroidery.
- The underneath part of the cloth was then cut out.
- Using the control panel of the embroidery machine, the antenna pattern was selected.
- The substrate with the fabric support was then mounted on the frame and attached to the machine.
- The initial position of the embroidery process was selected using the control panel.
- Speed of the embroidery settings was kept at a minimum.
- The entire embroidery process consisted of 232 steps, where the insertion and ejection of the needle was counted as a step.
- Using the foot control, the embroidery process was carried out.

Figure 5-4 below is a representation of the substrate mounted on a white cloth.



Figure 5-4: Substrate mounted on a white cloth and embroidered

However, due to some of the challenges faced during the embroidery process, which will be discussed in the discussions section later in this document, the bobbin thread used was of a different, nonconductive material.

Of the several tag antennas that was attempted to be embroidered using the above process, due to the challenges encountered in the fabrication process, a total of 8 embroidered tag antennas were finally selected for testing. The rest of the samples, due to improper embroidery outcomes, were discarded. After the preparation of the antenna patterns, conductive glue, which is DuPont PE872, a stretchable conductive silver paste, was used to attach the tag IC, which is NXP UCODE G2iL RFID IC [42], and was left overnight for the glue to dry. Figure 5-5 below depicts the tags with the ICs attached, assorted according to their infill patterns and densities, and Table 1 provides the details of the tags that were selected for the stretch tests.

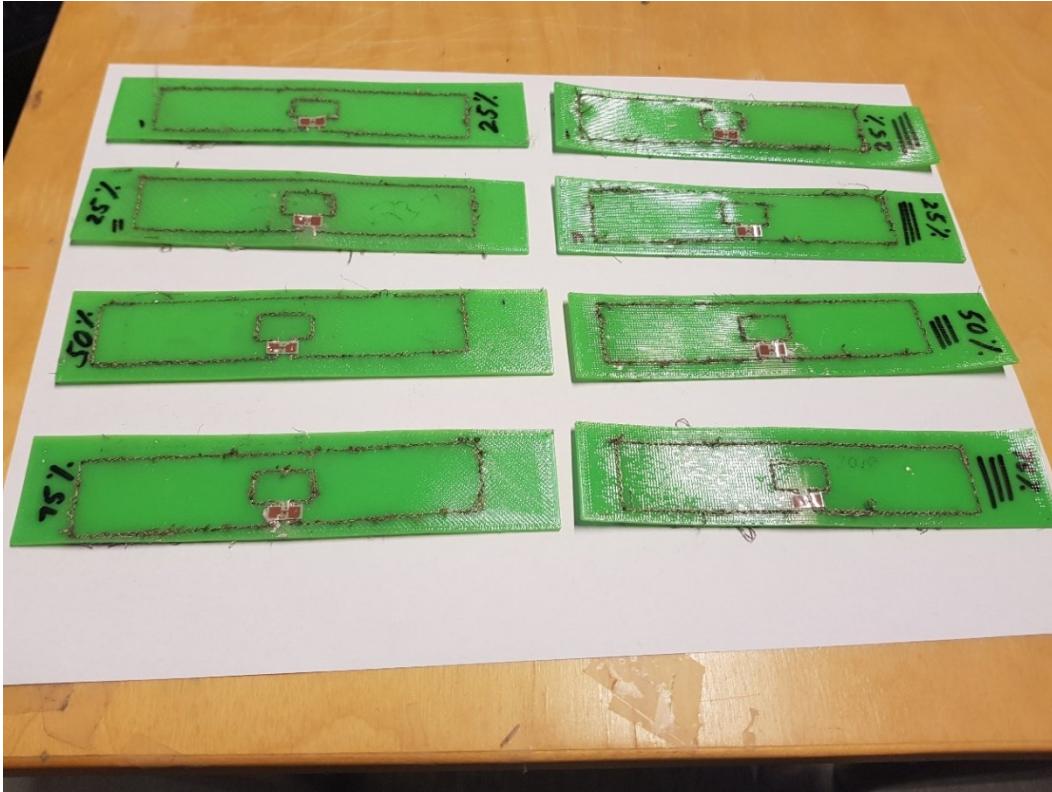

Figure 5-5: The prepared tags, after the embroidery process and IC attachment

Table 1: Description of the tags produced

Infill percentage and density	Number of units
25 % horizontal (top 2 at the right)	2
25 % rectilinear (top 2 at the left)	2
50 % horizontal (third tag at the right)	1
50 % rectilinear (third tag at the left)	1
75 % horizontal (fourth tag at the right)	1
75 % rectilinear (fourth tag at the left)	1

### 5.3 Antenna testing

The testing of the prepared antennas was done using Voyantic's Tagformance Pro device, which is a device used for measuring and testing RFID tags in their development stages. It is a measurement system comprising of the measurement device, as shown in figure 5-6 below, its associated software, and accessories.





Figure 5-6: The Tagformance device [43]

The Tagformance Pro's software is an easy to use interface designed to conduct and observe the testing of tags on a variety of parameters, some of which are:

- **Threshold:** The measurement setup sweeps through the entire range of the frequency range that is provided to the device, and determines the minimum transmit power for correct tag response, at every frequency point. This test determines the sensitivity and the tuning levels of tags. The software can be used to test multiple tags at the same screen, enabling comparative analysis.
- **Backscatter:** Within a specified frequency range, the measurement setup sweeps through the entire frequency range, and measures the signal response strength at each frequency point, hence determining the tag's power levels
- **Orientation:** Radiation patterns of the tags under test is determined using this feature of Tagformance Pro, where the tags are rotated using the rotational system of the measurement setup and every point's measurement is recorded, within the specified frequency range.
- **Read Range:** Measurement of the read range capabilities of the tag determines the range of the tag's response with respect to the reader's signal as a function of frequency.
- **Population management:** This function is used for managing multiple tags. In this function, individual tags are managed when multiple tags are being read by the reader.

The Tagformance Pro setup also includes several accessories enabling to perform a wide variety of measurements based on the user's needs. For this experiment, one of the components used is the RFID measurement cabinet, where reduction of the influence of outside interferences and improvement of accuracy was its key factors. Its setup consists of a space and its inner walls

padded with absorbers, and an arrangement for placing of a Tag rotation device and the mounting of a reader antenna in one of the inner walls, essentially providing the conditions for measurements within an ideal environment [43].



Figure 5-7: The Tagformance Pro's test cabinet [43]



Figure 5-8: Inside view the Tagformance Pro's cabinet [43]

## 5.4 Stretching tests

The machine used for the stretching test of the tags was Instron 4411 Tensile Strength Tester. It is a machine used for testing the tensile strength or compressive force of materials. It is an electromechanical universal testing system consisting of a load capacity of 5 kN, with a speed range of 0.5-500 mm/min, which is the speed at which the grips move apart from each other (tensile), or towards each other (compressive). Specimens are loaded onto the frame and measurements of tensile or compression, with value of load, usually extensive or compressive, with breaking point and maximum load measurements can be recorded. It comprises of an easy to use interface where initial values can be inputted, and an RS-232 port for communications with a computer [44].



Figure 5-9: Instron 4411 Tensile Strength Tester [44]

## 6. MEASUREMENT AND DISCUSSIONS

### 6.1 Initial stretch tests

The substrates prepared by the company, Prenta Oy, as mentioned earlier were subjected to the tensile testing machine, Instron 4411, for the initial stretch tests to observe the performance of the substrates under some stress conditions.

The substrates were setup on the machine as follows: Initially a load of 5 kN was attached to the machine, after which the appropriate clamps were connected. A serial RS-232 connector was connected from the interface of this machine with the computer present near the machine, and from its associated software, the input parameters, including the dimensions of the sample and the speed at which the arms of the machine will move, were set. The specimens to be tested were mounted on the arms, and the stretch test was done automatically after the specific parameters are given to the control panel interface which is attached to its side. Figure 6-1 below illustrates the setup.



Figure 6-1: Substrate setup on the Instron 4411 Tensile testing machine

The rectilinear substrates were tested first, followed by the horizontal substrates. The tests were indicated as tensile tests, with pneumatic grips used for holding the substrates, and the load given was 5 kN. The crosshead speed, i.e. the speed at which the arms of the testing machine moved apart from each other was 20.00 mm/min.

The following figure i.e. figure 6-2 represents the graphical outcome of the stretch tests. The graph below depict the Displacement encountered by the substrates with increase in the Load.

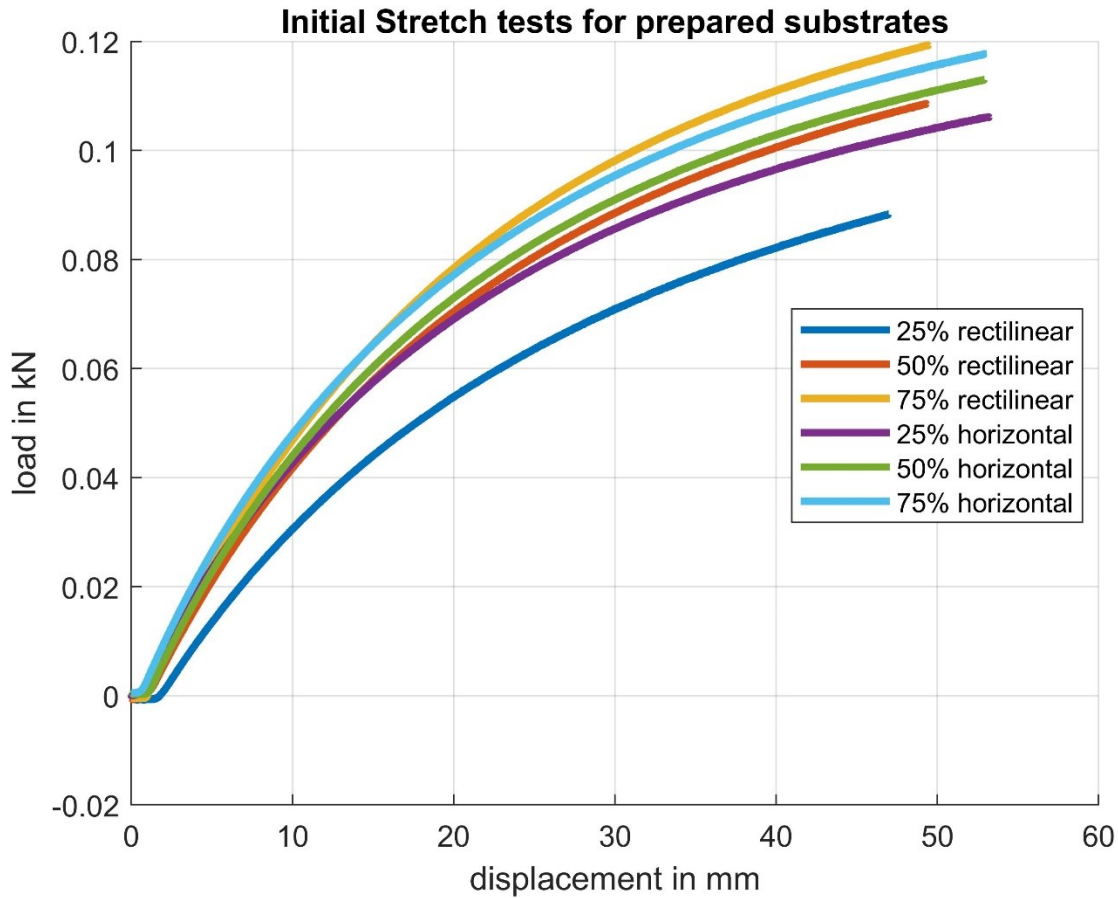

Figure 6-2: Initial Stretch test outcomes

As observed from the graph above, the force required to displace the tags at the same length was dependent on the infill percentage of the substrates, where a higher infill percentage meant a larger force was required for the same displacement. With regards to the 25 % infill substrates, there was a significant difference in the load required to extend the substrates for a similar length. For example, the load required to extend a 25 % rectilinear substrate for 20 mm was approximately 0.058 kN, whereas the load required for the same extension of the horizontal substrate was 0.064 kN. Hence, it is understood, from the various data points of both the curves that the force required to stretch a 25 % horizontal substrate was higher than the 25 % rectilinear substrate, for the same extension length. However, for the other substrates, i.e. the 50 % and 75 % horizontal or rectilinear, the amount of force required for the same extension was relatively similar.

The tags were stretched at an additional 0.2 cm from their original length, but however, all the tags returned to their original shape, i.e. their original lengths of 14 cm, with the 25 % infill substrates

returning much quicker (typically within a few minutes) than the 75 % infill substrates (over several hours), and the 50 % substrates behaving in a manner in between the other 2 infill densities, i.e. the 25 % and the 75 % substrates.

## 6.2 Tag preparation and testing

The various challenges encountered during the embroidery process was:

- The conductive thread was very weak, resulting in it breaking at almost every 5-10 steps of the embroidery process.
- The bobbin thread (the thread which is used for automatically making a knot underneath the surface of the material), didn't make a proper knot with the thread coming from the top of the substrate. Hence, a cluster of loose threads accumulated below the surface of the substrate. To remedy this problem, a different bobbin thread was used, which was non-conductive and stronger. It did help remedy the embroidery process to some extent (refer to figure 6-3).
- Initially it was observed that the default thread tension was kept at a value of 3.0, hence when the thread went in the substrate, the drawing out of the thread in the next step was very soft, hence not pulling out the thread properly. Increasing the thread tension to a value of 5.8-6.0 helped in better performance and helped in reducing the cluster formation below the substrate.
- The alignment of the substrate with respect to the embroidery pattern was also challenging, as the alignment was done manually. Offsets and angular misplacements occurred in the final pattern.

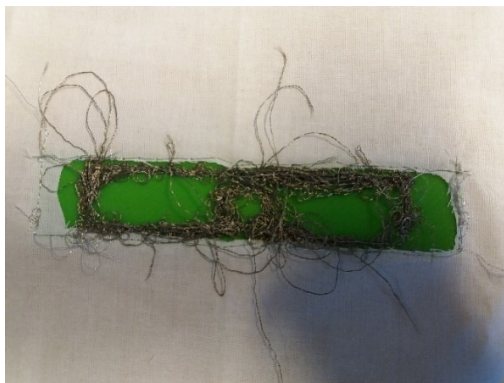

Figure 6-3: Formation of clusters at the bottom side of the substrate after embroidery

The clusters which were formed in almost all the tags with varying degrees, were cut out carefully with scissors, to maintain the antenna pattern at the bottom to the best possible manner.

Embroidering of the antenna pattern was also dependent on the infill density. For the 25 % substrates, the embroidering of the antenna pattern was relatively easier, due to a lesser infill percentage. With regards to the 50 % and the 75 % infill samples, the difference in the ease of

embroidery was not very significant, but for the 75 % samples, the embroidery process was relatively harder, and the 50 % samples were intermediate of the other two samples.

The tag IC attachment using the conductive glue was done manually, and hence, the probability of human errors in the IC placement and alignment was very high.

### 6.3 Microscopic observations

The following images represents the microscopic images of the tags that were taken after the embroidering and IC attachment processes, and prior to the final stretch tests.

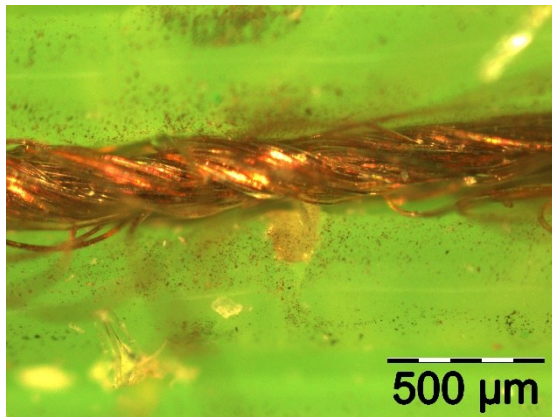
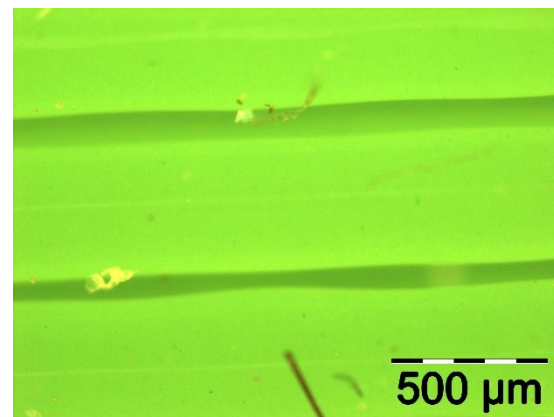

Figure 6-4: 25 % horizontal a) matching part



b) substrate part

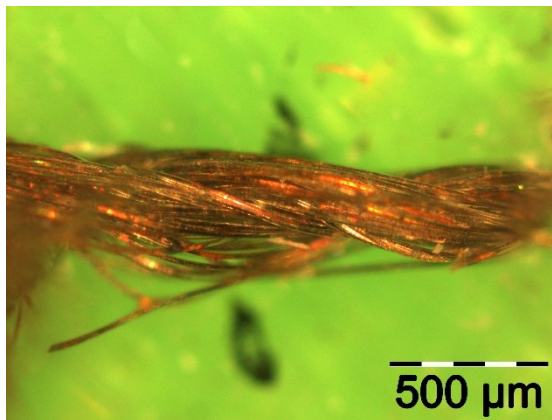
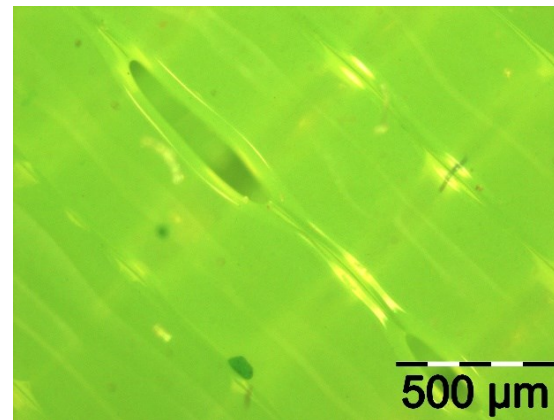

Figure 6-5: 25 % rectilinear a) matching part



b) substrate part

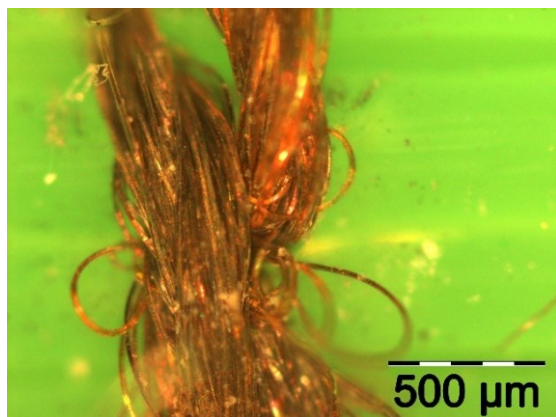
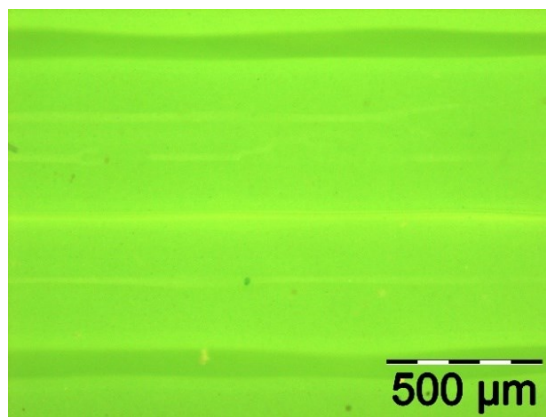

Figure 6-6: 50 % horizontal a) matching part



b) substrate part

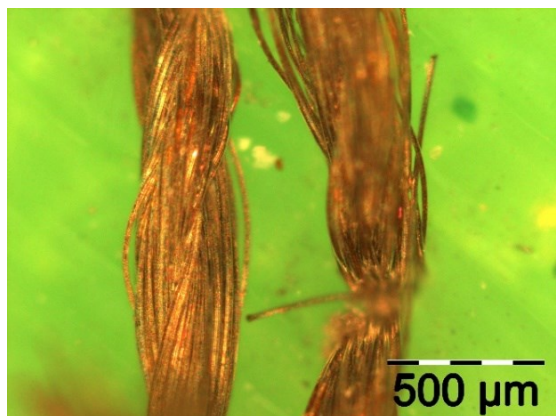
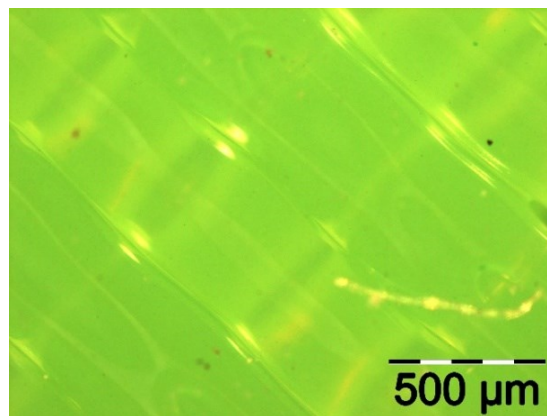

Figure 6-7: 50 % rectilinear a) matching part



b) substrate part



Figure 6-8: 75 % horizontal a) matching part

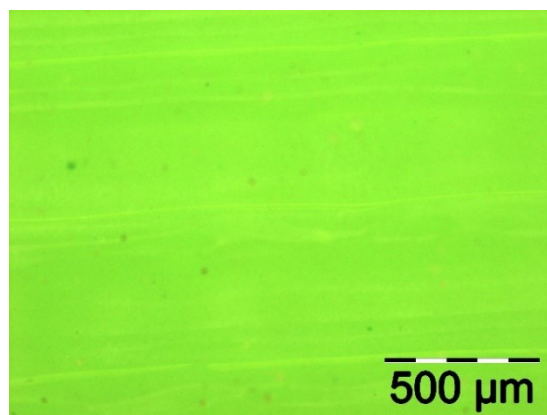

b) substrate part



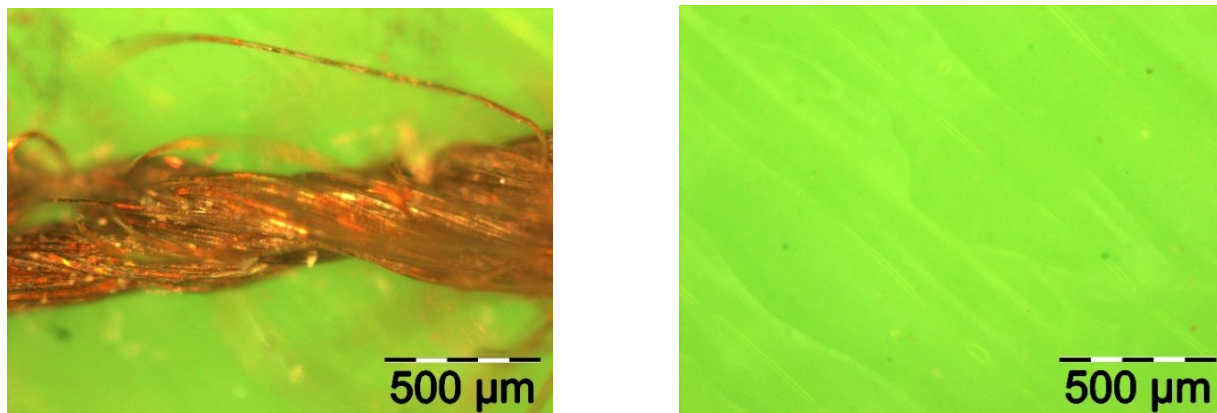

Figure 6-9: 75 % rectilinear a) matching part

b) substrate part

## 6.4 Antenna Testing

### 6.4.1 Anechoic testing

The prepared tags were tested within the possibly ideal environment of the Tagformance Pro's measurement cabinet. Initially the cabinet was calibrated using the reference tag provided with the Tagformance Pro's accessories kit. The frequency range for testing was kept at a range of 800 MHz – 1000 MHz. The following graphs depict the various read ranges recorded by each individual tag.

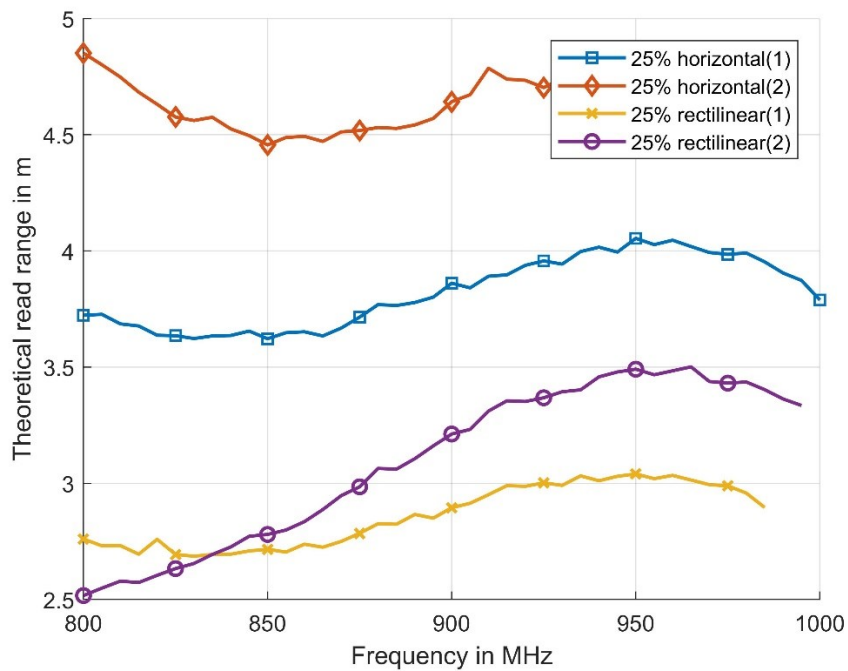

(a) 25 % tags

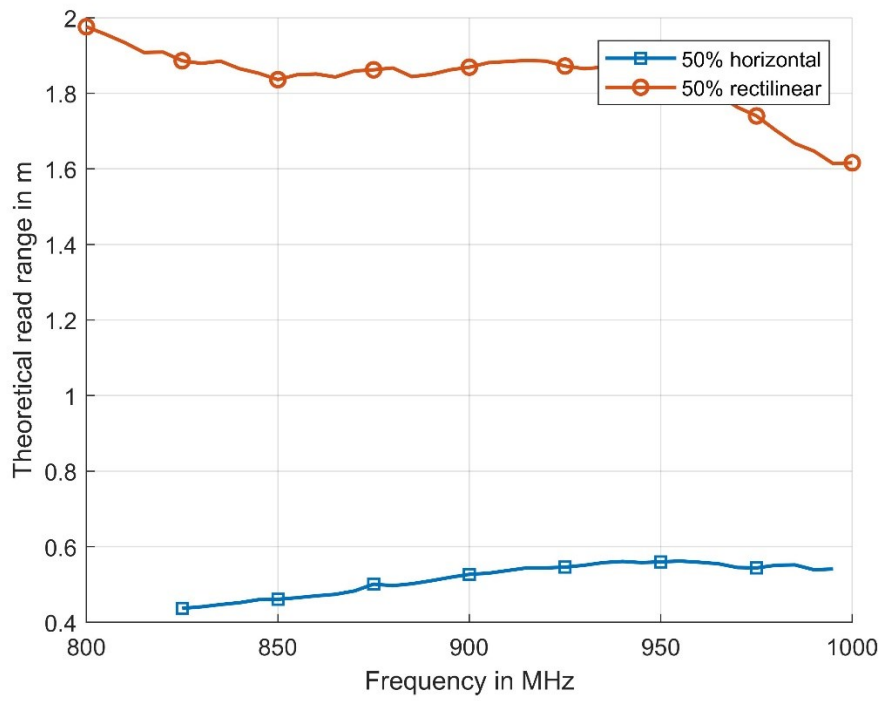

(b) 50 % tags

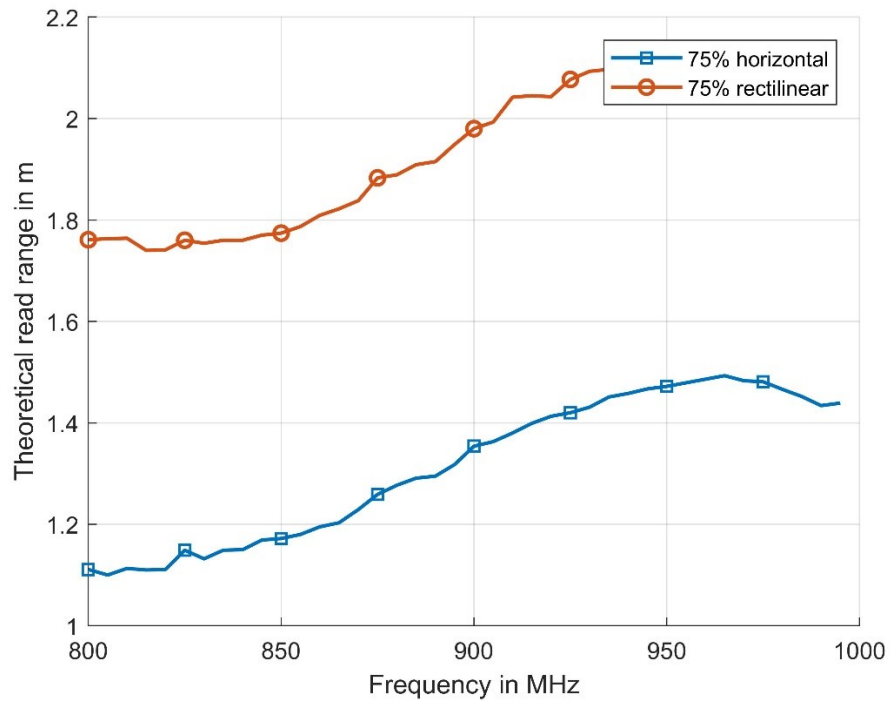

(c) 75 % tags

Figure 6-10: Anechoic Chamber test outcomes for (a) 25 % tags, (b) 50 % tags and (c) 75 % tags

Initially, for the 50 % horizontal tag, there was no output being recorded, but upon firmly pressing the tag IC on the antenna pattern, the curve 6-10 (b) was visible.

### 6.4.2 Free space measurements

After the above test, the tags were tested in an open space, with the reader antenna kept at 1m from the tags. The reader antenna was calibrated with the reference tag, and the frequency range was kept at the same range of 8 MHz – 1000 MHz. Figures 6-11 (a), (b) and (c) below depicts the read range recorded for each individual tag.

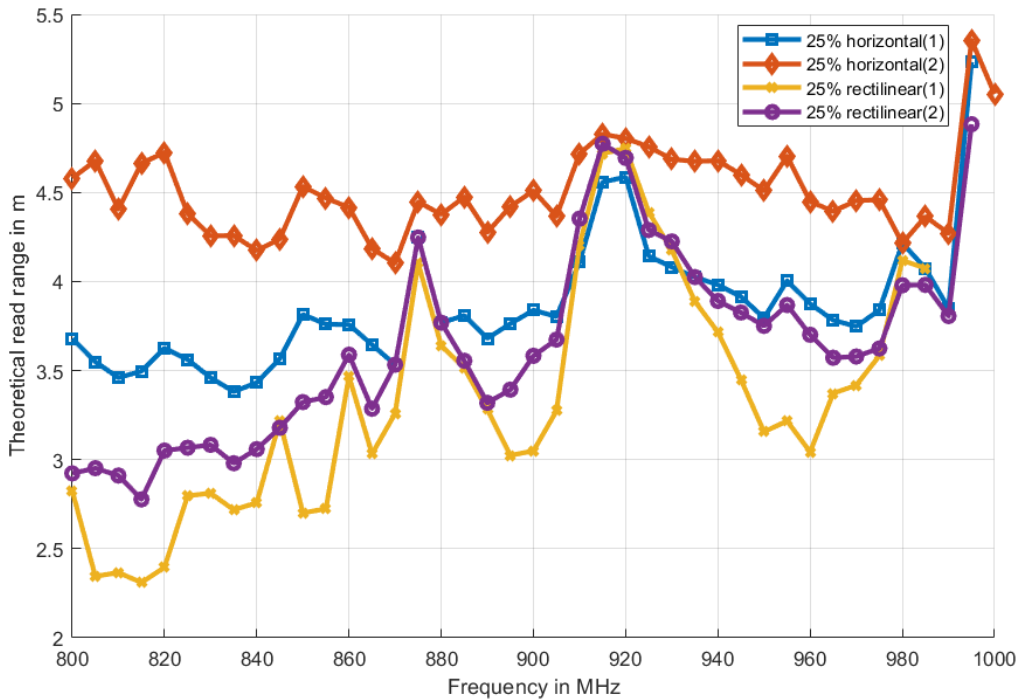

(a) 25 % tags

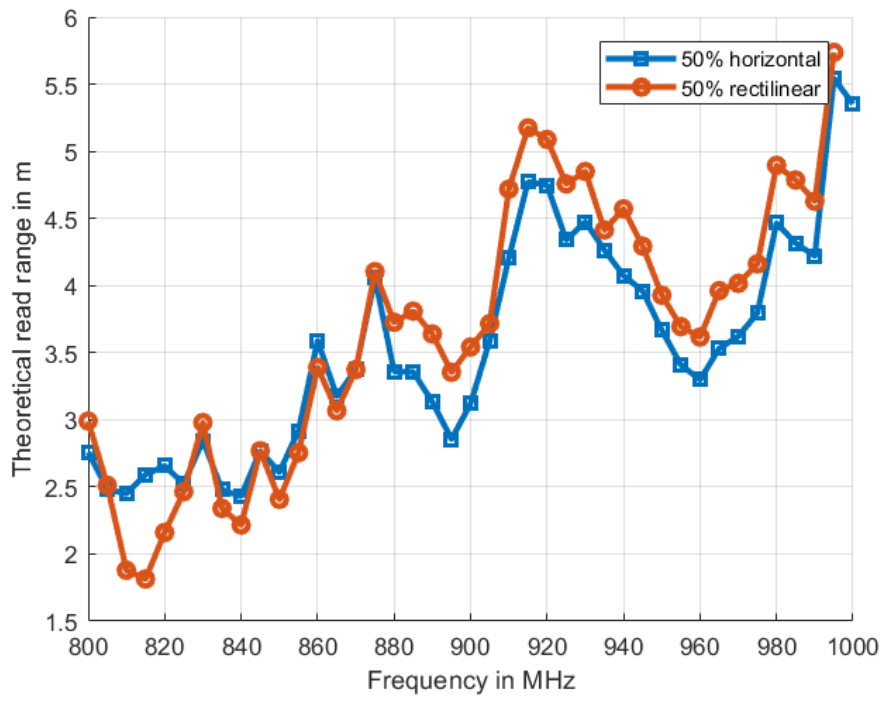

(b) 50 % tags

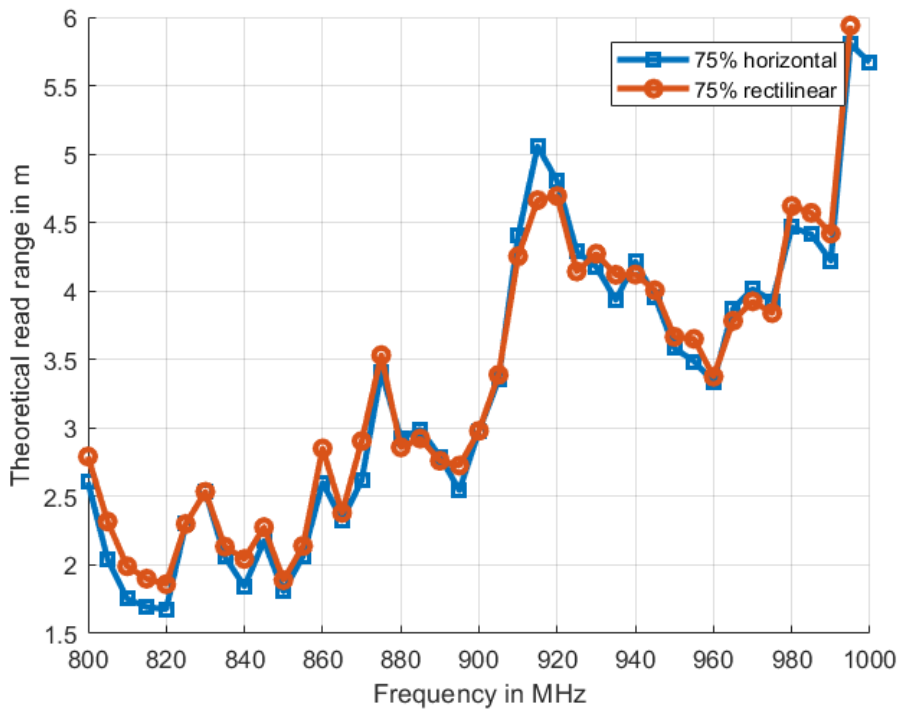

(c) 75 % tags

Figure 6-11: Free space measurements

### 6.4.3 Stretch tests

After the above process, the tags were subjected to the stretch test, where the read range values and the tensile test values were being recorded simultaneously. Maintaining the same setup for both the measurement apparatuses, i.e. the Instron 4411 and the Tagformance Pro software with its reader antenna, the following curves were obtained.

The samples used for the stretch test were the 25 % horizontal (1) and the 25 % rectilinear (1), 50 % horizontal and rectilinear samples, and the 75 % horizontal and rectilinear samples.

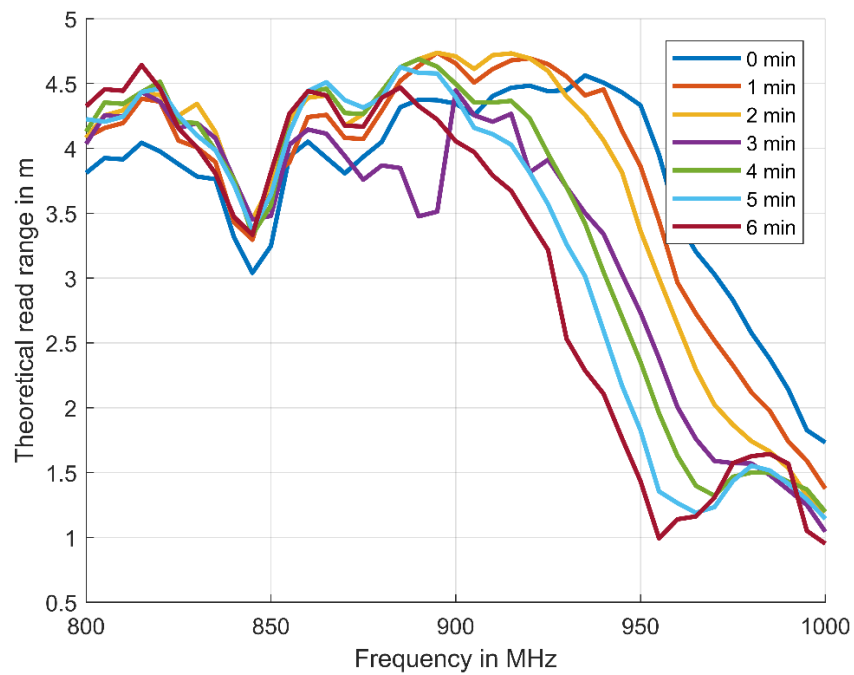

Figure 6-12: 25 % horizontal tag response during stretch test

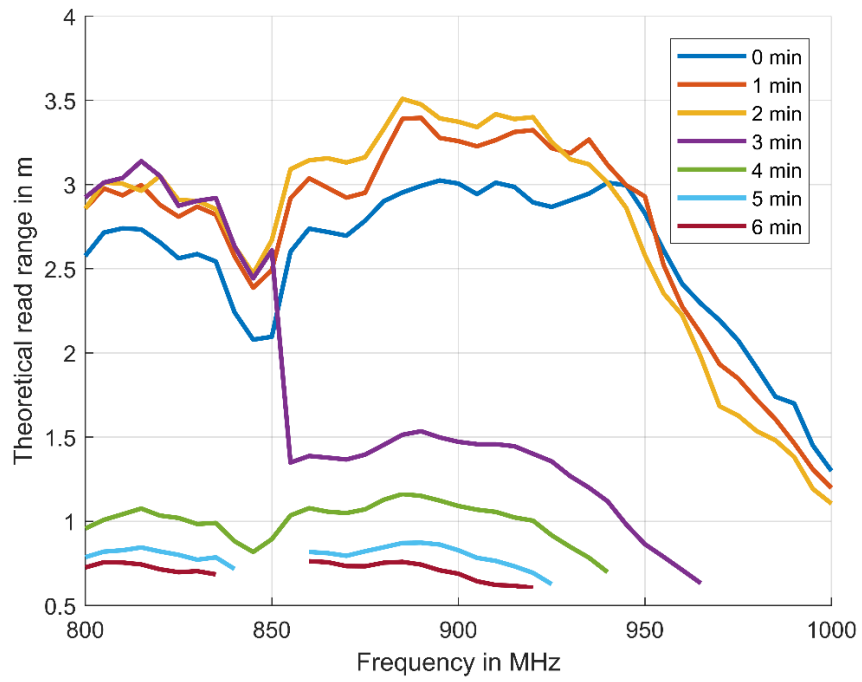

Figure 6-13: 25 % rectilinear tag response during stretch test

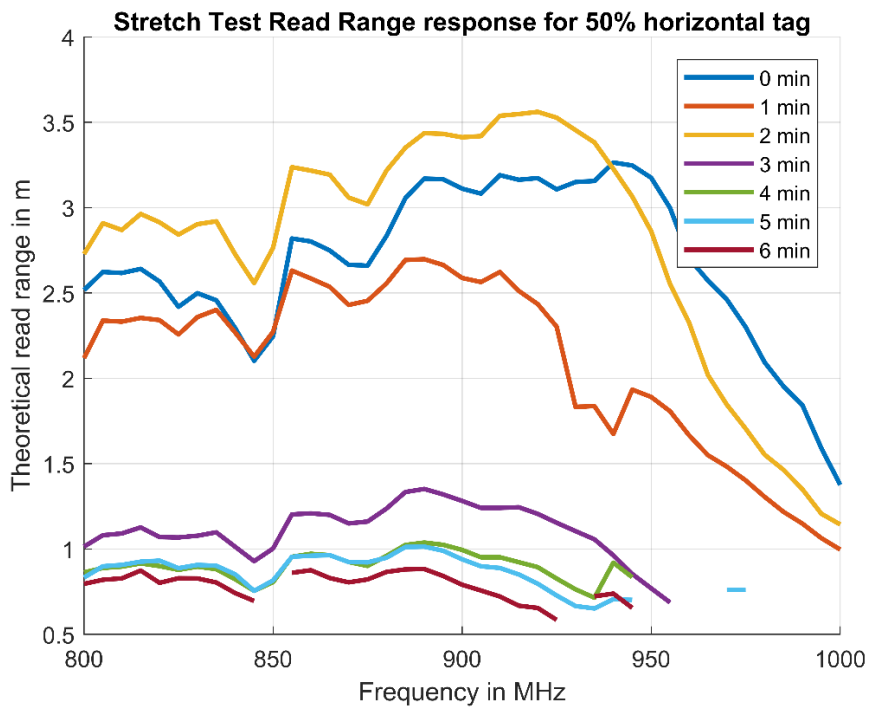

Figure 6-14: 50 % horizontal tag response during stretch test

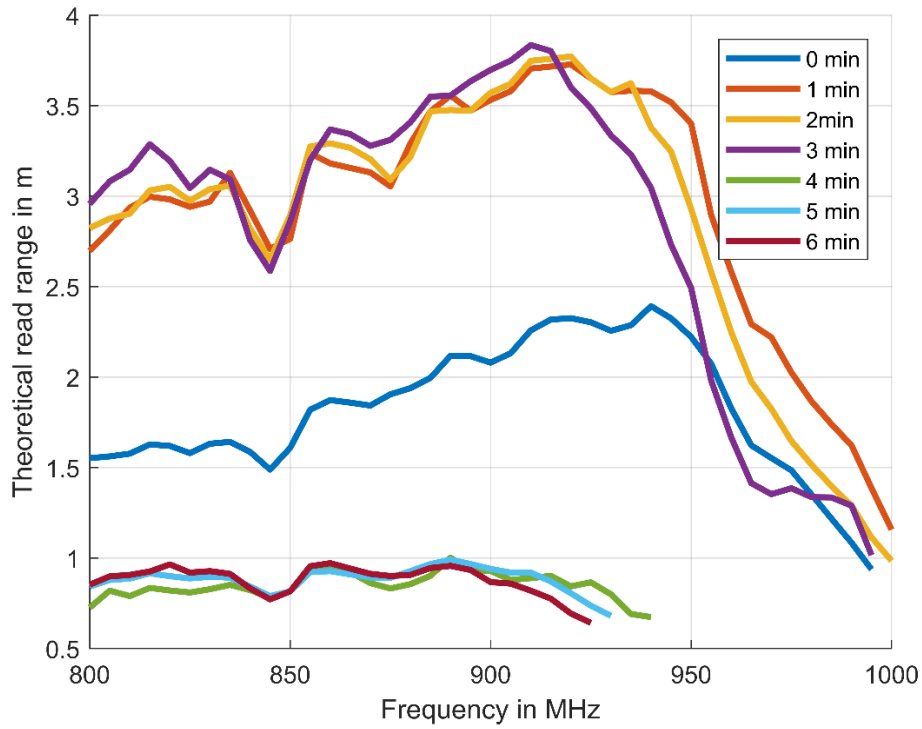

Figure 6-15: 75 % horizontal tag response during stretch test

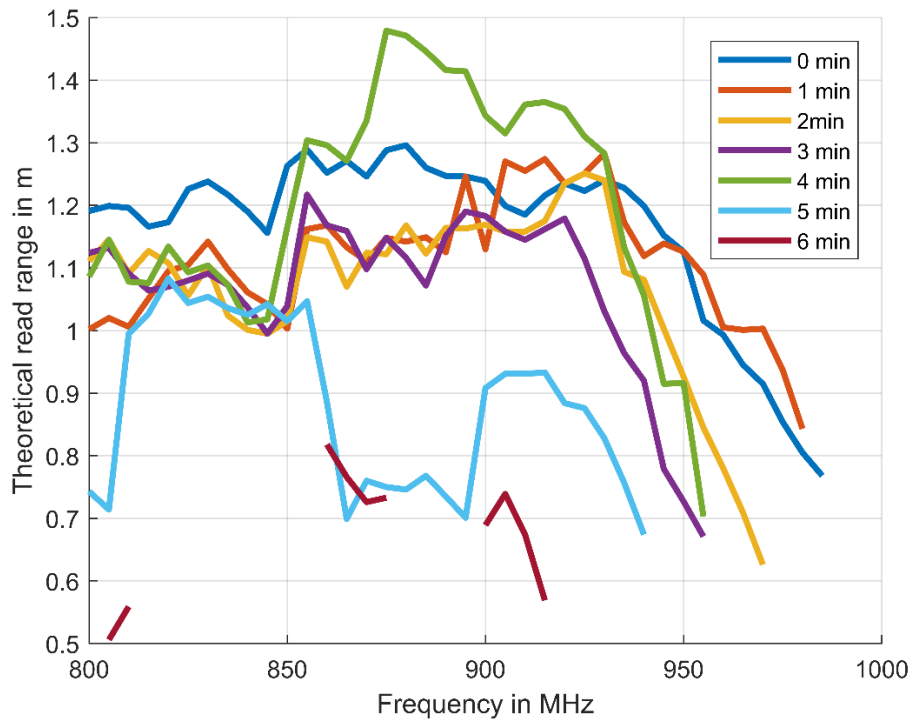

Figure 6-16: 75 % rectilinear tag response during stretch test

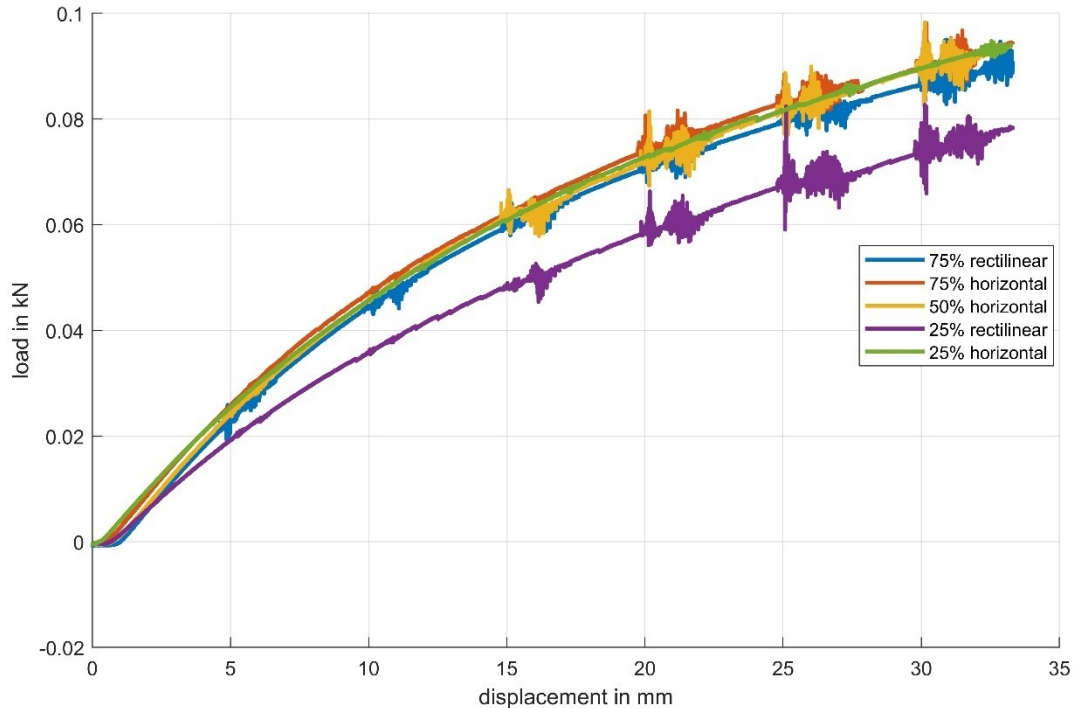

Figure 6-17: Final stretch test

The tensile test was maintained at a speed of 5.00 mm/min, i.e. the speed at which the grips moved apart from each other.

From the stretch tests results of figure 6-17, the stretching force required for pulling a substrate depended on the infill percentage, with a higher amount of force required for the 75 % tags, and a lower force required for the 25 % tags. This outcome of the substrate's stretch behavior was like the initial stretch tests.

From the anechoic and the free space measurements, it was observed that the read ranges of the tags differed considerably between the two tests. The anechoic test was conducted in the most ideal environment possible, whereas during the free space measurements, several other factors like reflection, refraction, scattering and diffraction of the reader signal affected the read range of the tags. For the 25 % tags, the anechoic and the free space results did not differ significantly, but for the 50 % and 75 % infill tags, the read ranges varied significantly.

Based on the above curves and the observations during the stretch test, it is observed in almost all the cases that the tags were depicting a read range value for the entirety of the frequency sweep, approximately during the first 4 minutes. After 4 minutes, where the tags were stretched beyond 80 mm from its original size, the tags depicted a gradually reduced read range, with inconsistent data, and by the 6<sup>th</sup> minute, the tags provided little or no data.



The 50 % rectilinear substrate, when placed on the testing machine, displayed little or no data at all, despite several attempts.

There were several factors that determined the outcome of the above stretch tests. One of the most important one is the presence of a high quantity of metal around the tag when the test was being conducted, due to the metallic structure of the tensile test machine. This could be the possible explanation of the difference of the tag's free space measurement data and the data acquired during the 0<sup>th</sup> minute of the stretching machine test. The other factor is that the factor of the substrate's necking during the stretch test, which affected the matching part of the tag antenna pattern, and hereby affecting the tag IC itself.

Despite the above-mentioned factors, the conclusion deduced from the above tests were that the RFID tags under stress were able to effectively communicate with the reader up to an extension of 20 mm from its original size. However, since the number of samples used for every infill density and pattern used was one of each, increasing the sample size of the same may result in different conclusions.

## 7. CONCLUSIONS

In this thesis, 8 flexible substrates were developed using FDM methods of printing, of differing infill densities and patterns, which in turn were used to develop passive UHF RFID tags using embroidery techniques. These tags were subjected to stretching conditions, and their electrical performance during the test was observed.

Although the tests depicted a common pattern of outcomes, the development of the tags were not without its challenges. Some of the embroidery challenges was already mentioned in Section 6.2, however, some of the other challenges were inconsistency of the antenna pattern formation for each substrate, as the tags were developed manually. Apart from the above, the positioning of the tag IC during its placement on the matching part of the antenna pattern also varied considerably.

However, the most important factor determining the outcome was the presence of a lot of metal, attributed to the testing machine used for the stretching test. It is estimated that if the presence of the metal could be avoided, the outcome of the test could have been considerably better.

Despite the above challenges, some of the tags, especially the 25 % infill tags gave us higher values of read ranges as compared to the other ones. This may be since fabrication of the antenna pattern was relatively easier on a less dense substrate.

The outcome of this experiment could be improved further by using a stronger and more durable conductive thread that could be used in the embroidery process, a more automated process of embroidery, and a metal free testing environment for the stretch tests for better testing conditions, and hence, obtaining improved results.

## 8. REFERENCES

- [1] D. Kim, J.A. Rogers, Stretchable electronics: Materials strategies and devices, *Advanced Materials*, Vol. 20, Iss. 24, 2008, pp. 4887-4892.
- [2] T.Q. Trung, N. Lee, Materials and devices for transparent stretchable electronics, *J.Mater.Chem.C*, Vol. 5, Iss. 9, 2017, pp. 222-2222.
- [3] M.M. Hussain, J.P. Rojas, G.A.T. Sevilla, A.M. Hussain, M.T. Ghoneim, A.N. Hanna, A.T. Kutbee, J.M. Nassar, M. Cruz, Free form CMOS electronics: Physically flexible and stretchable, 2015 IEEE International Electron Devices Meeting (IEDM), IEEE, pp. 19.4.4.
- [4] J.A. Rogers, T. Someya, Y. Huang, Materials and Mechanics for Stretchable Electronics, *Science*, Vol. 327, Iss. 5973, 2010, pp. 1603-1607.
- [5] D. Kim, J. Xiao, J. Song, Y. Huang, J.A. Rogers, Stretchable, curvilinear electronics based on inorganic materials, *Advanced materials* (Deerfield Beach, Fla.), Vol. 22, Iss. 19, 2010, pp. 2108-2124.
- [6] R. Noorani, *3D Printing: Technology, Applications, and Selection*, 1st ed. CRC Press, Milton, 2017, .
- [7] T.J. Coogan, D.O. Kazmer, Bond and part strength in fused deposition modeling, *Rapid Prototyping Journal*, Vol. 23, Iss. 2, 2017, pp. 414-422.
- [8] A.S. Bala, S.b. Wahab, M.b. Ahmad, Elements and Materials Improve the FDM Products: A Review, *Advanced Engineering Forum*, Vol. 16, 2016, pp. 33.
- [9] I. Kovalenko, M. Garan, A. Shynkarenko, P. Zelený, J. Šafka, Examining the Relationship between Forces During Stereolithography 3D Printing and Geometric Parameters of the Model, *MATEC Web of Conferences*, Vol. 40, 2016, pp. 2005.
- [10] M. Alssabbagh, A.A. Tajuddin, M. Abdulmanap, R. Zainon, Evaluation of 3D printing materials for fabrication of a novel multi-functional 3D thyroid phantom for medical dosimetry and image quality, *Radiation Physics and Chemistry*, Vol. 135, 2017, pp. 106-112.
- [11] 3D Printing-Overview  
, <https://learn.adafruit.com/3d-printing-with-ninjabflex/overview>.
- [12] E. Tyson What is the difference between TPE and TPU filaments,  
<https://rigid.ink/blogs/news/172062855-what-is-the-difference-between-tpe-and-tpu-flexible-filament>.
- [13] S. Moscato, R. Bahr, T. Le, M. Pasian, M. Bozzi, L. Perregrini, M.M. Tentzeris, Infill-Dependent 3-D-Printed Material Based on NinjaFlex Filament for Antenna Applications, *IEEE Antennas and Wireless Propagation Letters*, Vol. 15, 2016, pp. 1506-1509.

- [14] B. Evans, Practical 3D Printers : The Science and Art of 3D Printing, 1st ed. Apress L. P, Berkeley, CA, 2012, .
- [15] R. Bahr, T. Le, M.M. Tentzeris, S. Moscato, M. Pasian, M. Bozzi, L. Perregrini, RF characterization of 3D printed flexible materials - NinjaFlex Filaments, 2015 European Microwave Conference (EuMC), EuMA, pp. 742-745.
- [16] K. Nate, M.M. Tentzeris, A novel 3-D printed loop antenna using flexible NinjaFlex material for wearable and IoT applications, 2015 IEEE 24th Electrical Performance of Electronic Packaging and Systems (EPEPS), IEEE, pp. 171-174.
- [17] M. Rizwan, W. Khan, H. He, J. Virkki, L. Sydänheimo, L. Ukkonen, Flexible and stretchable 3D printed passive UHF RFID tag, 2017, .
- [18] Ninjatek, <https://ninjatek.com/resources/printing-guidelines/>.
- [19] D.M. Dobkin, I. Books24x7, The RF in RFID: passive UHF RFID in practice, Elsevier / Newnes, Amsterdam; Boston, 2007, .
- [20] A.L. Borja, A. Belenguer, J. Cascon, J.R. Kelly, A Reconfigurable Passive UHF Reader Loop Antenna for Near-Field and Far-Field RFID Applications, IEEE Antennas and Wireless Propagation Letters, Vol. 11, 2012, pp. 580-583.
- [21] V. Chawla, D.S. Ha, An overview of passive RFID, IEEE Communications Magazine, Vol. 45, Iss. 9, 2007, pp. 11-17.
- [22] J. Kabachinski, An introduction to RFID, Biomedical Instrumentation and Technology, Vol. 39, Iss. 2, 2005, pp. 131-134.
- [23] H. Lehpamer, I. Books24x7, RFID Design Principles, Artech House Inc, Norwood, 2007, .
- [24] D. Shen, V.O.K. Li, Fundamentals of Wireless Communications, in: Anonymous (ed.), Springer Berlin Heidelberg, Berlin, Heidelberg, 2006, pp. 7-43.
- [25] H.J. Visser, I. Books24x7, Antenna Theory and Applications, 1st ed. John Wiley & Sons Inc, Hoboken, 2012, .
- [26] C.A. Balanis, Antenna Theory, Wiley, 2015, .
- [27] G. Ginestet, N. Brechet, J. Torres, E. Moradi, L. Ukkonen, T. Bjorninen, J. Virkki, Embroidered Antenna-Microchip Interconnections and Contour Antennas in Passive UHF RFID Textile Tags, IEEE Antennas and Wireless Propagation Letters, Vol. 16, 2017, pp. 1205-1208.
- [28] R. Seager, S. Zhang, A. Chauraya, W. Whittow, Y. Vardaxoglou, T. Acti, T. Dias, Effect of the fabrication parameters on the performance of embroidered antennas, IET Microwaves, Antennas & Propagation, Vol. 7, Iss. 14, 2013, pp. 1174-1181.

- [29] X. Chen, A. Liu, Z. Wei, L. Ukkonen, J. Virkki, Experimental Study on Strain Reliability of Embroidered Passive UHF RFID Textile Tag Antennas and Interconnections, Journal of Engineering, Vol. 2017, 2017, pp. 1-7.
- [30] M. Rizwan, M. Guibert, A. Massicart, J. Torres, L. Sydanheimo, L. Ukkonen, T. Bjorninen, J. Virkki, Embroidered passive UHF RFID tag on flexible 3D printed substrate, 2017 Progress in Electromagnetics Research Symposium - Fall (PIERS - FALL), IEEE, pp. 818-822.
- [31] E. Koski, K. Koski, T. Bjorninen, A.A. Babar, L. Sydanheimo, L. Ukkonen, Y. Rahmat-Samii, Fabrication of embroidered UHF RFID tags, Proceedings of the 2012 IEEE International Symposium on Antennas and Propagation, IEEE, pp. 1-2.
- [32] M. Toivonen, T. Bjorninen, L. Sydanheimo, L. Ukkonen, Y. Rahmat-Samii, Impact of Moisture and Washing on the Performance of Embroidered UHF RFID Tags, IEEE Antennas and Wireless Propagation Letters, Vol. 12, 2013, pp. 1590-1593.
- [33] R. Want, An introduction to RFID technology, IEEE Pervasive Computing, Vol. 5, Iss. 1, 2006, pp. 25-33.
- [34] B. Shrestha, A. Elsherbeni, L. Ukkonen, UHF RFID Reader Antenna for Near-Field and Far-Field Operations, 2011, .
- [35] RFID Systems : Research Trends and Challenges, John Wiley & Sons, Incorporated, Hoboken, 2010, .
- [36] K.D. Wong, Fundamentals of Wireless Communication Engineering Technologies, John Wiley & Sons, 2012, .
- [37] J. Pelleg, Mechanical Properties of Materials, Springer, Dordrecht, 2012, .
- [38] W.F. Hosford, Mechanical Behavior of Materials, 2nd; 2 ed. Cambridge University Press - M.U.A, New York, 2009, .
- [39] I.P. Jones, Materials science for electrical and electronic engineers, Oxford University Press, Oxford, 2001, .
- [40] Prenta Duo 3D Printer, <http://www.prenta.fi/en/3d-printers-services/3d-tulostimet/prenta-duo>.
- [41] Husqvarna Viking Ruby Royale, available at [http://www.husqvarnaviking.com/SiteMedia/Products/Machines/-%20DESIGNER%20RUBY%20Royale/Manual/Ruby\\_Royale-manual-EN.pdf](http://www.husqvarnaviking.com/SiteMedia/Products/Machines/-%20DESIGNER%20RUBY%20Royale/Manual/Ruby_Royale-manual-EN.pdf) .
- [42] SL3S1203\_1213 UCODE G2iL and G2iL+, NXP Products, 2014, available at [https://www.nxp.com/docs/en/data-sheet/SL3S1203\\_1213.pdf](https://www.nxp.com/docs/en/data-sheet/SL3S1203_1213.pdf) .

[43] RFID Testing and Measurement for Tag Development and Selection, JUKKA VOUTILAINEN, 2015, available at <http://voyantic.com/downloads/download-the-tagformance-pro-catalogue>. Accessed 22-06-2018

[44] INSTRON 4411 TENSILE STRENGTH TESTER, <https://www.thelabworldgroup.com/instron-4411-tensile-strength-tester>.