



TAMPERE UNIVERSITY OF TECHNOLOGY

**MIKKO LAAJA**

**GENERAL PLANNING PRINCIPLES OF HIGH VOLTAGE DISTRIBUTION  
NETWORKS INCLUDING WIND POWER**

Master of Science Thesis

Examiner: Professor Pertti Järventausta  
The examiner and the topic approved in  
the Faculty of Computing and Electrical  
Engineering Council meeting on  
7.9.2011

## ABSTRACT

TAMPERE UNIVERSITY OF TECHNOLOGY

Master's Degree Programme in Electrical Engineering

**LAAJA, MIKKO:** General planning principles of high voltage distribution networks including wind power

Master of Science Thesis, 72 Pages, 9 Appendix pages

August 2012

Major: Power systems and market

Examiner: Professor Pertti Järventausta

Keywords: Network planning, high voltage distribution network, wind power, demand side management

In Finland, the high voltage distribution networks (HVDNs) include all 110 kV lines which are not part of the transmission network of the Finnish electricity transmission system operator, Fingrid. Currently, the role of the HVDNs in the business operations of the network companies is generally relatively small. This is because the amount of network renovations to the networks and the construction needs for new HVDNs are small. However, this will probably change in the future, since the planning needs of the HVDNs will increase with the increasing amount of wind power in the networks. In addition, the effects of wind power on the HVDNs are relatively unknown, since the majority of the wind power research focuses on the effects of wind power on the whole power network or on the effects of small wind plants on 20 kV or low-voltage networks.

This thesis is a part of a Finnish national 5-year research program called Smart Grid and Energy Market (SGEM). The main purpose of this thesis is to describe the general planning principles of the HVDNs and to analyze the effects of large-scale wind power production on the different types of HVDNs in Finland. Moreover, the thesis aims to examine what kind of impacts the wind power plants in the HVDNs have on the planning and operation of the networks. In addition, the thesis will study the advantages and disadvantages of demand side management (DSM) in the planning and operation of the HVDNs with wind power.

The thesis consists of making a literature survey about the subject, which is supported by general level network simulations with a HVDN test system with two wind farms and by interviews with some network operator personnel. The simulations of the thesis examine the wind power capacity of the different types of HVDNs, the variability of the load and wind power production in relation to each other, the voltage variations and power losses in the HVDNs with wind power and, finally, the effects of DSM on the wind power capacity, voltages and power losses of the networks. Actual measured data is being used in the simulations in the modelling of the fluctuations of the wind power production and network loads. In the end, the conclusions about the wind power effects on the HVDN planning and operation are made based on the literature survey, interviews and simulations.

## TIIVISTELMÄ

TAMPEREEN TEKNILLINEN YLIOPISTO

Sähkötekniikan koulutusohjelma

**LAAJA, MIKKO:** Tuulivoimaa sisältävien suurjännitteisten jakeluverkkojen yleissuunnittelun periaatteet

Diplomityö, 72 sivua, 9 liitesivua

Elokuu 2012

Pääaine: Sähköverkot ja -markkinat

Tarkastaja: Professori Pertti Järventausta

Avainsanat: Sähköverkon suunnittelu, suurjännitteinen jakeluverkko, tuulivoima, kysynnän hallinta

Suurjännitteisiin jakeluverkkoihin kuuluvat kaikki 110 kV:n voimajohdot, jotka eivät ole Suomen kantaverkkoyhtiö Fingridin omistuksessa. Tällä hetkellä suurjännitteisen jakeluverkon rooli verkkoyhtiöiden liiketoiminnassa on yleisesti melko vähäinen, mikä johtuu verkkojen vähäisestä saneeraustarpeesta ja pienestä uusien verkkojen rakennustarpeesta. Tämä asia tulee kuitenkin todennäköisesti muuttumaan tulevaisuudessa, sillä suurjännitteisten jakeluverkkojen suunnittelutarpeet tulevat kasvamaan tuulivoiman määrän kasvaessa verkoissa. Tämän lisäksi tuulivoiman vaikutukset suurjännitteisiin jakeluverkkoihin ovat suhteellisen tuntemattomia, koska suurin osa tutkimuksista keskittyy tuulivoiman vaikutuksiin koko voimansiirtoverkon tasolla tai pienten voimaloiden vaikutuksiin 20 kV:n verkon tai pienjänniteverkon tasolla.

Tämä työ on osa Suomessa käynnissä olevaa kansallista viisivuotista Smart Grid and Energy Market (SGEM) -tutkimusohjelmaa. Työn pääasiallinen tavoite on selvittää suurjännitteisen jakeluverkon yleissuunnittelun perusteita ja analysoida laajamittaisen tuulivoiman vaikutuksia erityyppisiin suurjännitteisiin jakeluverkkoihin Suomessa. Lisäksi työ pyrkii selvittämään, minkälaisia vaikutuksia suurjännitteisissä jakeluverkoissa olevilla tuulivoimaloilla on verkkojen suunnitteluun ja käyttöön. Työ myös selvittää kysynnän hallinnan hyödyt ja haitat tuulivoimaa sisältävien suurjännitteisten jakeluverkkojen suunnittelussa ja käytössä.

Työ koostuu aiheesta tehdystä kirjallisuusselvityksestä, jonka tukena toimivat yleisen tason simuloinnit kaksi tuulipuistoa sisältävän suurjännitteisen jakeluverkon simulointimallin avulla ja haastattelut sähköverkon toimijoiden henkilökunnan kanssa. Työn simuloinnit tarkastelevat erityyppisten suurjännitteisten jakeluverkkojen tuulivoimakapasiteettia, verkon kuormien ja tuulivoimatuotannon vaihteluiden suhdetta, tuulivoimaa sisältävien suurjännitteisten jakeluverkkojen jännitteitä ja häviöitä ja lopuksi kysynnän hallinnan vaikutuksia verkkojen tuulivoimakapasiteettiin, jännitteisiin ja häviöihin. Simuloinneissa käytetään todellista mitattua dataa tuulivoimatuotannon ja verkon kuormien vaihteluiden mallintamisessa. Työn lopuksi tehdään päätelmät tuulivoiman vaikutuksista suurjännitteisen jakeluverkon suunnitteluun ja käyttöön perustuen kirjallisuusselvitykseen, haastatteluihin ja simulointeihin.

## PREFACE

This Master of Science Thesis was carried out at the Department of Electrical Energy Engineering of Tampere University of Technology as a part of Smart Grid and Energy Market (SGEM) project. The supervisors and examiners of the thesis were Professor Pertti Järventausta and Lic.Tech. Juhani Bastman.

First of all, I would like to thank Prof. Pertti Järventausta for giving me this interesting topic, ideas and feedback during the work. I would also like to thank Lic.Tech. Juhani Bastman for his guidance, advice and feedback. I also want to thank all of my other colleagues of the Department for the pleasant working environment and ideas. My last gratitude goes to my wife, Emma, and my family for the invaluable support throughout my studies.

Tampere, August 2012

Mikko Laaja

## CONTENTS

1. INTRODUCTION .....	1
1.1. Smart Grids.....	2
2. HIGH VOLTAGE DISTRIBUTION NETWORKS .....	5
2.1. Definition and structure of Finnish HVDNs .....	5
2.2. Role of HVDNs from network point of view .....	7
2.3. Wind farm's impacts on the role .....	8
2.4. HVDN calculation .....	9
2.4.1. Calculation model of HVDN .....	10
3. GENERAL PLANNING OF ELECTRICITY NETWORKS .....	14
3.1. Planning principles .....	14
3.1.1. Determination of network's current state .....	15
3.1.2. Drafting of network trends and forecasts.....	15
3.1.3. Comparison of action proposals and decision making .....	16
3.2. Boundary conditions of planning .....	17
3.2.1. Maximum thermal capacity .....	18
3.2.2. Voltage drop .....	18
3.2.3. Short-circuit current capacity and protection.....	20
3.2.4. Earth fault protection .....	21
3.2.5. Mechanical condition.....	22
3.2.6. Quality of supply .....	22
3.2.7. Environmental issues .....	23
3.3. Planning tools .....	24
3.4. General planning of HVDNs .....	24
3.5. Effects of Energy Market Authority regulation model on planning.....	26
4. WIND POWER AS PART OF HVDN.....	29
4.1. General .....	29
4.2. Interconnection laws and regulations .....	30
4.3. Network effects of wind power .....	35
4.4. Wind power effects on network planning .....	37
4.5. Wind power effects on network operation .....	39
4.6. HVDN network simulations .....	42

4.6.1. Network capacity .....	43
4.6.2. Load and wind power variability .....	46
4.6.3. Voltage variations .....	48
4.6.4. Losses.....	57
4.6.5. Demand side management .....	58
4.6.6. Summary .....	62
4.7. Noticing wind power in HVDC planning and operation .....	63
4.8. Development needs .....	65
5. CONCLUSIONS.....	67
REFERENCES.....	69
APPENDIX 1 - HVDC NETWORK TEST SYSTEM.....	73
APPENDIX 2 - INTRODUCTION OF HVDC NETWORK TEST SYSTEM .....	74
APPENDIX 3 - NETWORK CAPACITY SIMULATIONS .....	79

## ABBREVIATIONS AND NOTATION

$S_b$	Base power
$U_b$	Base voltage
$U_n$	Nominal voltage
$Z_b$	Base impedance
AMR	Automatic Meter Reading
CIS	Customer Information System
DG	Distributed Generation
DNO	Distribution Network Operator
DSM	Demand Side Management
ENTSO-E	European Network of Transmission System
FRT	Fault Ride-Through
HVDN	High Voltage Distribution Network
ICT	Information and Communications Technology
MIS	Maintenance Information System
MVDN	Medium Voltage Distribution Network
NIS	Network Information System
pu	Per-unit
RES	Renewable Energy Source
SGEM	Smart Grid and Energy Market
SLFE	Static Load Flow Equations
StoNED	Stochastic Non-smooth Envelopment of Data
TSO	Transmission System Operator
WACC	Weighted Average Cost of Capital

# 1. INTRODUCTION

International actions to reduce global warming have increased electricity generation from renewable energy sources (RES), especially from wind. Consequently, worldwide installed wind power capacity has exploded during the last decade and the growth is estimated to be continued in the future. This has highlighted the role of wind power in energy production, which has increased research on wind power and also on defining the impacts of the increased wind power on the power system. Usually these studies focus either on the impacts of large-scale wind power production on the whole power system and transmission network or on the impacts of distributed wind power generation on a medium voltage distribution network (MVDN), while effects on a high voltage distribution network (HVDN) are generally neglected. The HVDN is a new term for a sub-transmission network and it is used in this thesis since the HVDN is currently the official term for the case in the Finnish network business regulation.

This thesis is a part of a Finnish national 5-year research program called Smart Grid and Energy Market (SGEM), objective of which is to enable the implementation of the smart grid vision for network planning and operation. The project involves a number of Finnish universities, network companies and industrial partners.

The purpose of this thesis is to describe the general planning principles of the HVDNs and to analyze the effects of large-scale wind power production on the different types of HVDNs. Moreover, the thesis attempts to determine what issues must be taken into account by network operators when interconnecting wind farms to the network. The issues are being considered from the point of view of both the network planning and the network operation. The analysis is performed primarily for the Finnish HVDNs

The thesis consists of making a literature survey about the subject and carrying out some illustrative simulations with a network test system. The objectives of the simulations are to specify the effects of variable wind production on the HVDNs and to define the benefits for network planning and operation by using demand side management (DSM). The simulations are being executed with Power World Version 15 simulation software. Hence, one of the minor objectives of the thesis is to obtain experiences from the advanced functionalities of the program and to clarify, what kind of different matters can be examined by the software. In addition to the literature survey and to the simulations, the thesis consists of carrying out some interviews with network operator personnel.

The thesis begins with a short introduction to the smart grid vision, mainly from the SGEM program's point of view. After this, the thesis introduces the HVDNs in the Finnish electrical system and considers their role in the power delivery system at the moment and in the future. Also, the simulation model for the HVDNs is being explained. Next, the practises of the general planning of the electrical network are being introduced as well as some of the matters that have an influence on the general planning



of the HVDCs. Then, the thesis studies the interconnection of wind power to the HVDC. The impacts of wind power on the HVDCs are examined from both the network planning and the operation point of view. Also, the current laws and regulations related to the interconnection are presented. At the end of the thesis, conclusions and recommendations about the planning and operation of the HVDCs with the increased number of wind power are made considering all the examinations completed within the thesis. Lastly, a conclusion about the whole thesis is produced.

## 1.1. Smart Grids

Energy production from RES has grown rapidly in the past decades and will presumably continue to increase even faster due to the countries' strict objectives to reduce greenhouse gas emissions. Many of the power plants using RES are small-scale plants that are geographically distributed. For that reason, the plants are usually connected to a distribution network instead of a transmission network. Traditionally, the electrical network includes centralized power plants connected to the transmission network and uncontrollable loads connected to the distribution network, which means that almost all of the production is located in the transmission network. This enables the power to be transferred in one direction from the transmission network to the consumption through the distribution network, in which case the power flow in the distribution network is unidirectional and quite simple to control from the network's point of view. However, the increase of distributed generation (DG) in the distribution network leads to a multi-directional power flow in the network, which will add complexity to the network planning and operation. Therefore, a demand for more intelligent and flexible power networks, 'smart grids', has emerged.

There are many drivers, in addition to the penetration of DG, for transforming the current power network towards the smart grid vision. One of the most significant of the drivers is the demand to increase the energy efficiency, especially at a customer level. The network's energy efficiency can be improved with the smart grids by increasing the network's utilization rate, which will lead to more optimized network planning and operation. At the customer level, this mainly means that the loads will become more active and controllable from the network's point of view. On that account, the using of real-time data on the planning and operation of the network should probably be increased in the future. Another driver for the smart grids is the fact that power quality requirements are rising at the same time as the disturbances caused by the weather are increasing due to climate change. Moreover, climate change will also raise the risk of major disturbances, which is serious because of the society's high dependency on the electric power. Maybe the simplest driver for the smart grids is the fact that many of the components of the existing networks are close to the end of their lifetime and consequently must be replaced anyway in the near future. This enhances the cost-effectiveness of the novel components needed for the smart grid. (Järventausta et al. 2010)

As mentioned above, the smart grids increase the intelligence and flexibility of the power networks. The intelligence is achieved by adding more information and communications technology (ICT) components to the network, which will enable the real-time monitoring and operation of the network. This will also increase the reliability and energy efficiency of the network. Simultaneously, a high amount of ICT will enable the network interconnection of a large number of controllable resources, for example directly controllable loads, energy storages, plug-in electric vehicles and DSM, which will significantly increase the flexibility of the network. Basically, DSM means that the loads of the network are controlled in some way which is beneficial for the network. This can mean that the peak loads of the network are being smoothed or the loads of the network are being increased or decreased temporarily to improve the adequacy of the network or to adjust the frequency of the network.

Generally, it can be said that the smart grid has the following characteristics (Hashmi 2011):

- Accessible, by granting connection access to all network users, particularly for RES and high efficiency local generation with zero or low carbon emissions.
- Integrated, in terms of real-time communications and control functions.
- Interactive between customers and markets.
- Flexible, by fulfilling customers' needs while responding to the changes and challenges ahead.
- Predictive, in terms of applying operational data to equipment maintenance practices and even identifying potential outages before they occur.
- Adaptive, with less reliance on operators, particularly in responding rapidly to changing conditions.
- Reliable, by assuring and improving security and quality of supply, consistent with the demands of the digital age with resilience to hazards and uncertainties.
- Economic, by providing the best value through innovation, efficient energy management, competition and regulation.
- Secure from attack and naturally occurring disruptions.
- Optimized to maximize reliability, availability, efficiency and economic performance.

The conversion of the existing networks to the smart grids also leads to other benefits for different stakeholders. At first, network operators will experience lower distribution losses and potentially peak demand could be reduced, due to the more optimized use of the network. In addition, the more optimized use of the network will also reduce CO<sub>2</sub> emissions and benefit the environment. Furthermore, the smart grids will expedite the proliferation of RES, which also benefits the environment. Finally, consumers will have an opportunity to control their energy costs by controlling their consumption and possible own generation. This will raise energy efficiency in the consumer level and also reduce emissions. (ABB 2009)

The transition of the networks to the smart grids will raise the operations of the power delivery system to the next level and it will benefit all stakeholders of the

networks. However, the transition will be complicated and difficult, since it will be as radical as all the advances of the power networks in total over last hundred years and it must be performed in a much shorter period of time. Therefore, a fruitful cooperation between all the stakeholders, for example network operators, industry players and both public and regulatory bodies, is essential. (ABB 2009)

## 2. HIGH VOLTAGE DISTRIBUTION NETWORKS

### 2.1. Definition and structure of Finnish HVDNs

Two types of networks are used in the Finnish power system for transferring electrical power from production to consumption. These types are a transmission network and distribution network. The transmission network forms the core of the Finnish power system as all the major power plants are connected to it. The network is designed and operated by Fingrid Oyj, which is the electricity transmission system operator (TSO) in Finland. The transmission network is a meshed network and it includes all 400 kV, 220 kV and 110 kV lines operated as meshed. The function of the transmission network is to transfer electricity from power plants to areas of consumption, from where the electricity is transferred to the majority of final consumers via distribution network, since only some of the largest consumers are connected directly to the transmission network. The distribution networks, the latter of the types mentioned above, are operated by regional network companies. The distribution networks can be divided into two different parts, medium voltage distribution networks (MVDNs) and high voltage distribution networks (HVDNs). The MVDNs are operated radially and they contain networks with voltages under 110 kV, according to the Finnish Electricity Market Act (Energy Market Authority 2007). Most of the consumers are connected to the MVDN directly or to a low voltage network, which is part of the MVDN.

The thesis concentrates on the HVDNs, especially on the rural HVDNs. The characteristics of these networks are next examined in detail. The term 'HVDN' has replaced an old term 'sub-transmission network' in the Finnish legislation and network business regulation. The HVDN can have similar characteristics with both the MVDN and the transmission network and, at the moment, there is no direct definition for the HVDN. Therefore, it is not entirely easy to say, which parts of the network are part of the HVDNs. (Bastman 2011)

According to the Finnish Electricity Market Act, the HVDNs consist of 110 kV lines which are not part of the Fingrid's transmission network (Energy Market Authority 2010a). In 2010, the length of this 110 kV HVDN network in Finland was about 8262 km, from which about 6559 km were possessed by 54 different distribution network operators (DNOs) and about 1703 km by 12 different high voltage distribution network operators. For comparison, the length of the Fingrid's 110 kV network was 7468 km, so about 52.5 % of the Finnish 110 kV lines are part of the HVDN. Figure 2.1 illustrates the distribution of the network ownership. (Energy Market Authority 2010b)

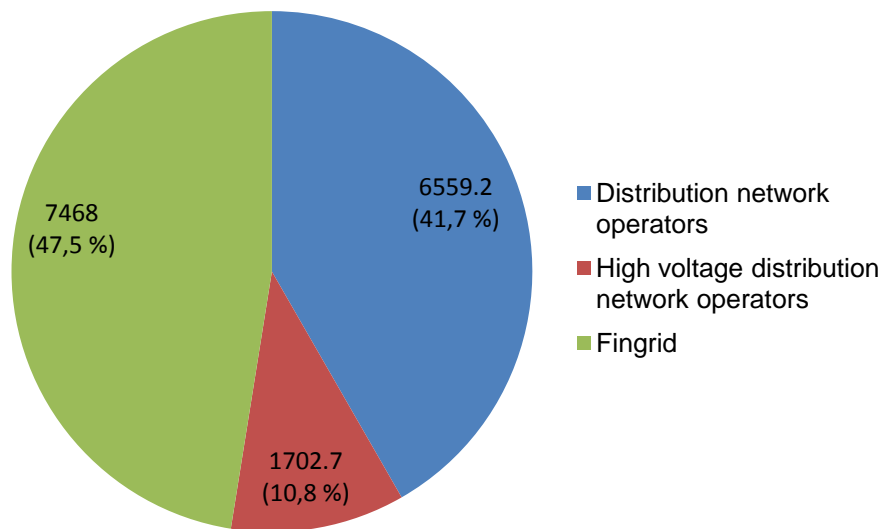

**Figure 2.1.** The 110 kV network lengths of the different owners in kilometres and as percentages of the whole 110 kV network.

About 98 % of the 110 kV network are overhead lines and underground cables are used only in urban areas. The HVDNs can be structured as either radial or meshed, and they can also be operated on either ways. Usually, the urban networks are structured as meshed, but operated radially. Also, the rural networks are invariably operated as radial. However, the structure of the networks varies as about 64 % of the rural HVDNs are meshed or partially meshed and 36 % radial. A meshed structure enables the use of a back-up connection in case of a fault, which increases network reliability, while radial operation keeps the protection of the network simple. The reliability of the HVDN is often improved by increasing the number of the transmission networks' feeding points, which enables a back-up connection from the transmission network in case of a feeding point fault. In addition, the operation mode of the HVDN can be modified in the case of multiple feeding points. When there is no electrical connection between the feeding points, the operation mode is called pocket operation, whereas the mode is called group operation when there is a connection between at least two feeding points. Moreover, the operation mode is called meshed operation, when as many as possible of the feeding points are interconnected. (Bastman 2011) The examples of the different operation modes of the network are presented in Figure 2.2. The term sub-transmission in Figure 2.2 refers to the HVDN. (Cigre 1995)

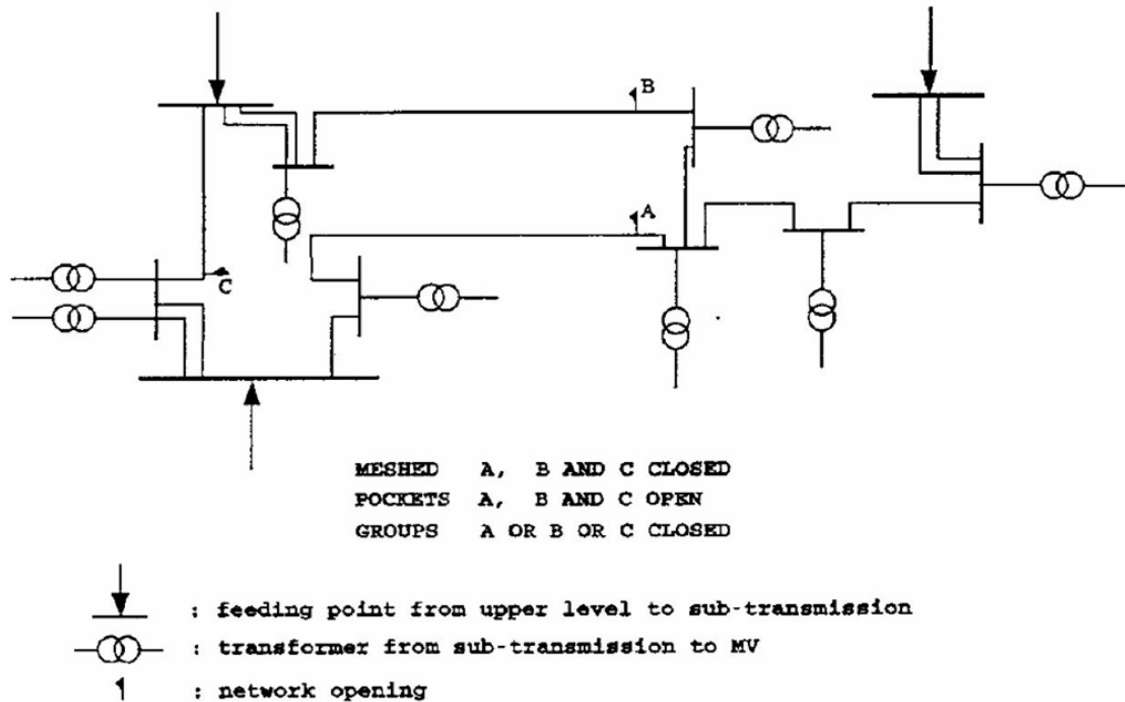

*Figure 2.2. The different operation modes of the HVDN. (Cigre 1995)*

Network earthing method varies geographically and randomly in Finnish HVDNs. In northern Finland, the HVDNs are compensated but in the rest of the country either partially earthed or isolated, from which the first is the most common method since the Fingrid's 110 kV transmission network and the majority of the HVDNs is partially earthed. The earthing of the network partially allows network operators to adjust earth fault current to a comfortable level which enables the tracking of the earth fault and does not pose a risk to humans. (Bastman 2011)

The protection of the HVDNs is usually implemented with distance relays, while another option for protection is differential relays which are used less commonly. The configuration of the protection is managed by either the network operator itself or it is outsourced to another company, typically to Fingrid. Nevertheless, in all cases the protection settings are adjusted in cooperation with the transmission network operator Fingrid. Communication is used in protection in about half of the companies, but the number is expected to increase in the future. (Bastman 2011)

## 2.2. Role of HVDNs from network point of view

In general, it can be said that the task of the HVDNs is to transfer electricity from a transmission network connection point to a distribution network connection point in areas where the transmission network is not geographically close to the distribution network. At the same time, the HVDN can also distribute electricity for the consumers that are connected to the HVDN. Consequently, the HVDN can have a role associated with both the electricity transmission and distribution. (Bastman 2011)

As mentioned earlier, the HVDNs are owned by two different network operators, DNOs and high voltage distribution network companies. The planning and operation of the HVDNs are based on objectives depending on the ownership of the network. Therefore, the HVDNs owned by the DNOs are optimized to serve the needs of the distribution networks connected to the HVDN and the HVDNs owned by the HVDN companies are optimized without considering the benefits of other networks. In conclusion, it can be said that the role of the HVDNs depends on the local network conditions and ownership.

According to the network company survey about the HVDNs in Finland, the companies value the HVDNs, especially the planning of the HVDNs, in different ways in their business. In one company, software capable of calculating meshed networks is used for planning the HVDN. On the contrary, in almost all other companies the planning calculations of the HVDNs are outsourced for another company, for example Fingrid, which might be reasonable, as Fingrid has capabilities for the 110 kV network planning. The planning of the HVDNs is further discussed in Chapter 3.4. (Bastman 2011)

Based on the Bastman's survey, it can also be noted that the fault statistics of the HVDNs are not at the same level as the MVDNs' statistics since the HVDNs' statistics are compiled by only 80 % of the companies and none of the companies have inclusive statistics on the prolonged time span. (Bastman 2011) In addition, the effects of faults on the regulation model of the Finnish Energy Market Authority are different in the cases of MVDN and HVDN, since the short interruptions and the number of the planned interruptions do not affect on the regulation model of the HVDNs. However, this will probably be changed for the next regulation period. (Energy Market Authority 2011) This issue will be discussed in more detail in Chapter 3.5.

These facts reflect the smaller role of the HVDNs from the network companies' point of view. On the other hand, the compiling of the HVDNs' fault statistics may not be so important for the companies, because faults occur in the HVDNs significantly less frequently than in the MVDNs. Nonetheless, the effects of the HVDN faults are much greater and spread over a larger area in the network than the effects of the MVDN faults.

### **2.3. Wind farm's impacts on the role**

Based on the previous chapter, it can be noted that the importance of the HVDNs from the network operator's point of view is not at the same level with the importance of the MVDNs. The difference is justified by the small size of the operators' HVDNs or by the low need for the HVDN expansions. These arguments are unlikely to apply in the future, because the HVDNs will probably be interconnected with a large number of wind farms. (Bastman 2011)

There were about 7 800 MW of wind power projects published in Finland by the end of January 2012 but it is difficult to say how many of those will be realized. Still, a

large part of the projects is covered by wind farms which will be connected to 110 kV network. Hence, a significant amount of wind power will most likely be connected to the HVDCs. (Finnish Wind Power Association 2012) The interconnection of the wind farms and the HVDC has several effects on the network, which will be identified in Chapter 4. In summary, the interconnection must be taken carefully into account in the planning, operation and protection of the network and it will emphasize the role of the HVDCs from the network operators' point of view. Handling of these issues by network planning and operation will be considered later also in Chapter 4.

## 2.4. HVDC calculation

In addition to making a literature survey about the HVDC planning, this thesis consists of carrying out some illustrative simulations with a HVDC test system. The objectives of the simulations are to specify the effects of variable wind production on the HVDCs and to define the benefits for network planning and operation by using demand side management (DSM).

The simulations were executed with Power World Version 15 simulation software which was chosen because it is simple, known and free software for performing load flow calculations in both the radial and meshed networks. Moreover, it is easy to transfer data from the software to Microsoft Excel and the software can be used to perform load flow calculations separately for each hour of the year, which means that the hourly fluctuations of the loads and wind power can be simulated conveniently. Power World can be used for wide range of network calculations including load flow calculations and fault calculations. However, the simulations of this thesis contain only load flow calculations so the other calculation features of the software are not being utilized. (PowerWorld Corporation 2012)

Power World simulation software includes a few different solution methods for load flow calculations, for example, a full Newton-Raphson, Decoupled Power Flow or Gauss-Seidel methods. Nonetheless, all of the calculations performed in the thesis are made using the full Newton-Raphson method, which is an effective and efficient calculation method for solving power flows of all sizes of networks. The solution solves the power flow of the network iteratively by solving Static Load Flow Equations (SLFE) for all system buses using the known parameters of the buses and bus admittance matrix. Moreover, if the calculation does not converge, the results of the power flow calculations are not reliable. (PowerWorld Corporation 2012; Bastman 2012)

Generally, when calculating the power flow of the network, the buses of the network are being divided into different categories depending on the known and unknown variables of the bus. These four variables, two of which are always known and two are calculated, are called the bus voltage, the angle of the voltage, the real power of the bus and the reactive power of the bus. Furthermore, the different categories for the network buses are SL -bus, PV -bus and PQ -bus. Firstly, the PV -buses, which are also known



as generator buses, are buses from which the real power of the generator and bus voltage are known and, in contrast, the reactive power of the generator and the angle of the voltage must be calculated. Secondly, the PQ -buses, also called as load busses, are buses from which the real and reactive power of the load are known and the amplitude and angle of the voltage are unknown. Lastly, the SL -bus is a bus from which the amplitude and the angle of the voltage are known and the real and the reactive power of the bus are unknown. Moreover, the SL -bus operates as a reference bus of the calculated network, and the real and the reactive power of the bus are determined so that the power balance of the network is achieved. Therefore, there is usually only one SL -bus in the network, and it is typically chosen to be the bus with the largest generator in the network or the bus which connects the calculated network to the larger network. (Bastman 2012)

### **2.4.1. Calculation model of HV DN**

The HV DN test system used in the simulations of this thesis is based on the test system which has been presented in work (Bastman 2011). The test system has been built to perform general level power flow and fault calculations in the HV DN and, therefore, the system is well suited for the calculations carried out in this thesis. (Bastman 2011) Additionally, certain modifications and improvements have been made to the system in the thesis, including the addition of two wind farms into the system and modifications of the parameters of some power lines in the system.

The test system used in the thesis includes three 400 kV substations, few 110 kV substations and two 20 kV substations. In addition, the test system includes seven load points with a maximum total load of 300 MW. Moreover, there are two wind farms in the system which both can be connected to two different points in the 110 kV network. The structure of the test system is shown in Figure 2.3 and Appendix 1. The 110 kV buses of the test system, which are mainly examined in the thesis, are shown in bold in Figure 2.3.

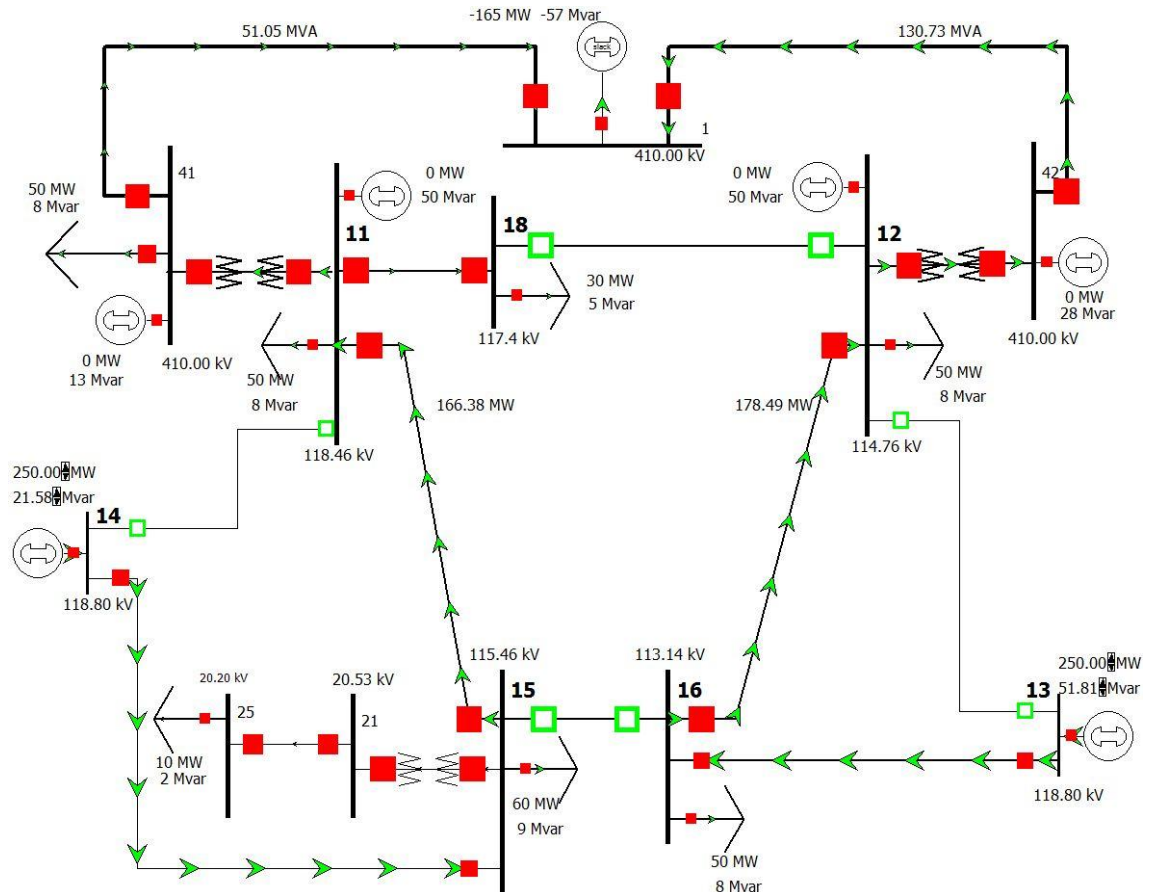

**Figure 2.3.** The HVDN test system in the maximum load situation and with wind farms connected to the existing 110 kV substations.

As has been shown in Figure 2.3, the test system has a meshed structure, which means that the network of the test system can be operated in a few different ways. This means that the simulations can be performed for various types of networks regarding to the operation mode of the network. If the lines between buses 12-18 and 15-16 are disconnected, like in Figure 2.3, the network is radial. On the contrary, the network can be operated as meshed by connecting either one or both of the lines, which means that one or more loops are being formed to the network.

In addition as has been shown in Figure 2.3, the two wind farms used in the simulations can be connected to the network in a few different ways, since both of the farms can be connected either to the 110 kV bus of the 400/110 kV substation or to the 110 kV substation further in the network. The situation, where the wind farms have been connected to the existing 110 kV substations, is presented in Figure 2.3 in the maximum load situation. Respectively, the situation, where the wind farms have been connected to the 400/110 kV substations, is presented in Appendix 1 in the minimum load situation.

The primary objective of the simulations of the thesis is to define the effects of variable wind production on the HVDNs. This is studied by performing power flow calculations with different settings of the test system by varying the operation mode of the system, the wind farm connection points and the nominal powers of the wind farms.

Then, the purpose is to compare the results of the different cases and make conclusions based on that.

In addition, since the objective of the simulations is to analyse the effects of wind power variability, the fluctuations of the wind farms' output power must be modelled in the simulations. This has been implemented by using actually measured wind power output data, which has been measured from one under 1 MW wind turbine in Hailuoto, Finland. The data contains the output of the wind turbine for each hour of the year, which enables the modelling of the hourly wind power variability. However, the output variations of one turbine differ from those of the whole wind farm and, therefore, the data has been modified so that one wind farm has been assumed to be consisting of two wind turbines of which outputs are experiencing the same phenomena with the difference of one hour. In other words, there is a one-hour delay in the production of the second wind turbine compared with the production of the first. Consequently, the output power of the wind farm is the average output of the two turbines, which models more realistically the output power of the wind farm.

Moreover, it is assumed that the two wind farms, which are connected to the test system, are located so that it takes also one hour for the weather events to move from the territory of the first wind farm to the territory of the second one. This is due to the fact that the wind farms, which are connected to the same HVDN, are generally not geographically adjacent to each other. Lastly, the output data of the two wind farms can be scaled to the appropriate level depending on the nominal powers of the simulated farms in each case.

The data modification balances the wind farm output variations compared to the output of the single wind turbine and, hence, improves the correlation of the data with the actual wind farm. However, the data does not probably fully correlate the output data of the actual wind farm with several 1-5 MW wind turbines, since it is impossible to model the stabilization of the wind farm's output power with the measuring data of one power plant. Moreover, the 1-5 MW wind turbines are higher than the under 1 MW turbines, which means that also the wind speeds experienced by the plants differ from each other. All in all, the main thing is that with the modification, the variability of the wind farm output can be modelled at some level, so that the effects of variability on the HVDNs can be studied.

Also the fluctuations of the network loads have been modelled in the simulations. This has been performed by using the hourly measured consumption of one distribution network operator (DNO). The data contains the consumption of the operator for each hour of the year and the minimum and maximum consumptions of the operator are about 7.5 MW and 33.7 MW, respectively. The real and reactive power consumption of the load points of the test system are assumed to vary identically throughout the year. Consequently, the measured consumption data has been scaled for each load point individually depending on the maximum load value of the point.

The reference bus of the test system is Bus 1 which has been thought to be connecting the system to the rest of the 400 kV transmission network. The voltage

control of the system has been implemented so that the voltages in the 400 kV substations are kept at 410 kV by the generators in the substations. The voltage control in the 110 kV network operates so that the voltages in the 110 kV buses of the 400/110 kV substations as well as the voltages at the connection point of the wind farm generators are intended to be kept at 1.08 pu, which is 118.8 kV. The details of the structure and operation of the test system have been described in Appendix 2.

## **3. GENERAL PLANNING OF ELECTRICITY NETWORKS**

### **3.1. Planning principles**

The objective of network planning is to ensure the reliability and sufficiency of the network in the future, which enables the distribution of good quality electricity to customers without unnecessary interruptions. This is being attempted to do as economically as possible and filling the technical requirements of the network. This means that the investments and other costs of the network, such as the costs of losses and maintenance costs, are being minimized while the electricity distribution must remain safe for the people, property and environment. However, maintaining or increasing the reliability of the network requires investments which reduce the economic efficiency of the network. In summary, it can be said that the network planning is an optimization task between the network investment costs, costs of losses, outage costs and maintenance costs (Lakervi & Partanen 2009).

The network planning is performed in a short-term and long-term. The short-term planning is usually implemented in no longer than a few years time period. Therefore, short-term plans are usually ultimate and more detailed than long-term plans. On the contrary, the time period of the long-term planning can be even 30 years so the plans are not made in such detail. Usually, the time period of the long-term planning is 10-20 years. The purpose of the long-term planning is to determine the main guidelines for the development of the network, and provide a basis for the short-term planning. The thesis focuses on the general planning of the network, which is long-term planning, so the short-term planning is not discussed in the thesis. (Lakervi & Partanen 2009; Vierimaa 2007; Jussila 2002)

The general planning of the network is affected by many different factors. The basis of the general planning is the current state of the network, in particular, how the network meets its reliability and safety objectives. The most important of the factors affecting on the general planning is load and production forecasting which provides a basic direction for the plans. Other important factors are the regulations imposed by authorities, for example, Energy Market Authority and the goals and requirements set by the companies themselves, which depend on the planning strategy of the company. In addition, the planning strategy of the company defines the appreciation of electric quality and landscape factors in the company which also affect on the general planning. Furthermore, the expertise of the planner and the efficiency of the information systems and planning tools can facilitate the general planning significantly. (Lakervi & Partanen 2009)

The general planning is slightly different in different network levels, depending on the size of the planned network. In MVDN companies, the planning is carried out only

for the company's own network, while other parts of the network are insignificant. On the contrary, in transmission network planning the whole network must be taken into account as well as the synchronously interconnected networks of the neighbouring countries. In Finland, the transmission network operator, Fingrid, forms plans for the transmission network based on the Ten-Year Network Development Plan of the European Network of Transmission System Operators for Electricity (ENTSO-E) (Reilander 2012a).

The planning of the HVDNs is in between the previous two planning practices. Since the HVDN planning is performed in cooperation with Fingrid, it is based on the transmission network plans. However, the planning is carried out regionally so the whole network does not need to be taken into account. The general planning of the HVDNs is further discussed in Chapter 3.4. (Reilander 2012a)

In general, the general planning of the network can be divided into three stages. The stages are the determination of network's current state, the drafting of network trends and forecasts, and the comparison of action proposals and decision making. (Jussila 2002)

### **3.1.1. Determination of network's current state**

The general planning starts from the determination of network's current state which defines the electrotechnical and mechanical condition and the economic situation of the network. Moreover, the reinforcement needs of the existing network are being diagnosed. Most of the data required for the process, for example, the network structure, consumption data and information about the condition of the components, is being obtained from the network information systems. In addition to this, the information systems can be used to perform load flow and fault current calculations.

The load flow and fault current calculations are used to determine, for example, the losses, voltage drops, load currents, short circuit and earth fault currents and operation of the network protection. The calculations are also being performed in unusual situations, such as fault or work interruption situations. With the calculations, the reliability, load capacity and safety of the current network can be evaluated and the possible parts of the network in need of reinforcements can be detected.

### **3.1.2. Drafting of network trends and forecasts**

At the second stage of the general planning process, the drafts about the network trends in the future and the forecast are being made. The most significant function in the process is the forecasting of loads, since the incorrectly predicted direction or speed of the load evolution leads to notable additional financial costs. Usually, loads increase rapidly in the urban networks and slowly or even not at all in the rural network. What makes the forecasting difficult, is the fact that the load changes may differ greatly within a small area, for example, in the rural network the loads can increase in the

summer cottage area and decrease in the other areas. The difficulty of the aggregation of these changes makes the forecasting more complicated and unpredictable. (Jussila 2002)

A wide range of means are used in load forecasting, for example, population, construction and business forecasts. Usually, the forecasts are mainly made using the local land use plans, which can be used to determine the types and amount of the loads expected to appear in the area in the near future. In addition, electricity price trends affect on the load forecasts and, therefore, assumptions about the prices must also be made. (Jussila 2002)

Equally important in the planning with the load forecasting is production forecasting, particularly in the transmission network and HVDN planning. Also in the MVDN planning, the production forecasting will be emphasized due to the increasing number of DG. The production forecasting is performed using virtually the same resources as in the load forecasting, since the most significant source for forecasts are the local land use plans of the municipality. However, the production forecasting is somewhat easier, at least in short-term, than the load forecasting because the electricity producers must inform the network operators directly about new power plant projects, since the producers need a network connection for their plants.

In addition to the previous, network development trends and changes in network's objectives also affect on the planning. Examples of these are the increasing appreciation of delivery reliability and the changes in the structure of the network due to the higher number of DG. Both of these will set new challenges for the network planning.

On the basis of all the issues presented, forecasts are made about power demand and supply in the network. The forecasts can be used to estimate the peak powers transferred in the network in the future. Hence, the development needs of the network can be assessed.

### **3.1.3. Comparison of action proposals and decision making**

In the last stage of the general planning, the action proposals are being made based on the forecasts about the future. Since the time span of the general planning is several years long, the forecasts and estimates for the future are not particularly accurate. This causes considerable uncertainty for the general planning. Therefore, flexibility is needed in the planning. This is achieved by making a few different versions, scenarios, about the plans with each having a different assessment of the future. This way, the plans can adapt to the future more flexibly. (Vierimaa 2007)

After making the network action proposals, the proposals are being considered, and after that final investment decisions are being made. Consequently, all the variety plans are compared, and on the basis of the comparisons the most suitable one is selected for execution. The main questions in making the decisions are (Lakervi & Partanen 2009; Jussila 2002):

- Should investments be made?
- Where the investments should be made?

- What kind of investment would be the most profitable to implement?
- When the investment should be implemented?

The general planning of the network is successful when the answers to these questions can be provided.

The comparison of the action proposals is not entirely easy and simple since the proposals can be compared in many different ways. The main requirement is that the proposal meets the technical boundary conditions of the network, such as regulations regarding the voltages and protection of the network. If the conditions are fulfilled, the order of the proposals is usually determined by costs. Nonetheless, the planning strategy of the company has notable influence on the final decision making, since the strategy can highlight some of the values of the proposals, such as the environmental impacts, network reliability or quality of the delivered electricity. In this case, the financially cheapest proposal is not necessarily the most suitable. Also, the interest rate and time period used in the calculations have impact on the decision making. (Lakervi & Partanen 2009; Jussila 2002)

Finally, the decisions about the investments in the network should be made based on the comparisons of the proposals. At this stage, the size of the investment plays a major role as it must be decided how substantial investments will be implemented. Since, it is more reasonable to do solely minor enhancement investment in some situations, for example, if major investments must be postponed or the forecasts indicate that the network's evolution will be small. Such investments are small individual changes in the network, such as wire exchanges or adding remote-controlled disconnectors. On the contrary, in some cases radical investments, such as the construction of new substation, are indispensable. The large investments are riskier than the small investments due to the uncertainty of the power forecasts. On this basis, network planners tend to make several minor investments instead of one major investment. The major investments are usually done only when large consumer or producer is joining the network, or the power quality must be significantly improved.

### **3.2. Boundary conditions of planning**

The general planning of the network is always based on the economic efficiency. The main objective of the planning is to optimize the costs within the imposed boundary conditions. Therefore, the final planning decisions depend substantially on the boundary conditions of the planning.

The boundary conditions include the technical boundary conditions, safety requirements and environmental issues of the network. To be precise, the following boundary conditions must be taken into account in the general planning (Lakervi & Partanen 2009; Jussila 2002):

- Maximum thermal capacity
- Voltage drop
- Short-circuit current capacity and protection



- Earth fault voltages and protection
- Mechanical condition
- Quality of supply
- Environmental issues

The planning of the network is done by keeping in mind the worst possible situation in the network. Therefore, the planning is performed using N-1 criterion which means that not a single fault must cause a network fall. The N-1 criterion has been found to be the optimal option in terms of the reliability and economy of the network.

### **3.2.1. Maximum thermal capacity**

Maximum thermal current carrying capacity determines how large load current can be conducted through the network for a certain period of time. In other words, it defines the power transmission capacity of the network lines. The maximum thermal capacity depends on the maximum temperature which can be allowed for the line on the basis of material, insulation or environment. In the case of 110 kV transmission lines, the dimensioning factor is usually the dip of the line which increases with increasing temperature. Consequently, the maximum thermal capacity of the line depends significantly on the outdoor temperature and wind speed, since both affect on the heat transmission of the line. (Reilander 2012a) The optimal current capacity of the line is determined with a term natural load of the line, since when the line is operating at its natural load, it produces as much reactive power as it consumes. This means that the line can be loaded with a maximum amount of active current, because a reactive current does not participate in the loading of the line.

The maximum thermal capacity of the network lines must be adequate in both load and fault current situations. In fault situations, the thermal capacity is higher because network protection limits the duration of the fault current. The thermal capacity is a dimensioning factor mainly with cables as the cooling characteristics of the overhead lines are better due to the favourable environmental conditions.

The importance of the maximum thermal capacity is highlighted in stand-by supply situations when the loads of the lines may grow significantly from normal loading situation. The thermal capacity may not be exceeded under any circumstances so all of the stand-by supply situations must be examined individually in the planning process, in order to determine the allowed load currents in all situations. Usually, one of the stand-by supply situations is a dimensioning case for planning in terms of thermal capacity. (Jussila 2002)

### **3.2.2. Voltage drop**

A voltage drop is typically the dimensioning factor of planning in overhead line networks, therefore its role as a planning factor is important. The voltage drop is caused by power transmission in the network, because the transmission creates the voltage drop

in the impedance of the power line. The voltage drop in the network depends on the active as well as the reactive power transferred in the line. If their directions are identical, which is usually the case, the voltage is lower in the power consuming end than in the power supplying end of the line. The voltage drop is usually expressed as the percentage value of the network's nominal voltage. The magnitude of the voltage drop depends on the properties, load and length of the line. Therefore, the voltage drop may become a problem particularly in the planning of long distance overhead line networks, such as rural networks in Finland.

The voltage drop is one of the power quality factors of the network. The Finnish national standard SFS-EN 50160 defines consumer connection point voltage characteristics which meet the quality regulations of power distribution. The standard provides limit values within which the customer can assume the voltage characteristics to remain. The standard defines the voltage characteristics separately for low voltage, medium voltage and high voltage supply, but the most meaningful, in terms of the voltage drop, are the characteristics of the most distant points of the network, the characteristics of the low voltage supply. The standard notes of the voltage variations of the low voltage network under normal operating conditions as follows (SFS-EN 50160 2011):

- During each period of one week 95 % of the 10 min root mean square values of the supply voltage must be within the range of  $U_n \pm 10 \%$ , where  $U_n$  is the nominal voltage.
- All 10 min root mean square values of the supply voltage must be within the range of  $U_n + 10 \%$  / - 15 %.

However, a good power quality can be defined so that the voltage remains  $U_n \pm 10 \%$  at all times. As a result, the voltage drop in the network is aimed to keep in no more than 5 %, excluding the stand-by supply situations, when the acceptable voltage drop is about 7-8 %. (Lakervi & Partanen 2009)

For the transmission network of Fingrid, the allowed voltage limits are slightly tighter. In Fingrid's 110 kV network, the normal range of the network voltages is 105-123 kV. However, during disturbances or in exceptional situations the allowable levels of voltages are 100-123 kV. (Fingrid Oyj 2007a)

If the voltage drop in the network is not at the desired level, it can be reduced by increasing the line thicknesses or number of the substation. Also, the acquisition of compensation capacitors, step-up transformers or reserve power generators decreases the voltage drop. Usually, a too high voltage drop is handled by increasing the thickness of the main line, which is the most profitable option. However, this may lead to short-circuit current capacity problems, which are discussed in Chapter 3.2.3. (Jussila 2002)

As listed above, the amount of the consumption also has a significant role in terms of the voltage drop. Therefore, the accurate prediction of load growth is extremely important to avoid incorrect investments in the network.

The increasing amount of the DG causes new challenges for the network planning, especially from the perspective of the voltage drop, because the DG raises voltages in

its vicinity when it produces power to the network. In some situations, the voltage rise may become the dimensioning factor instead of the voltage drop. Therefore, the voltage rise must be noticed in the planning also without forgetting the possible situation where the DG is disconnected and not producing power. Moreover, the production of the DG may vary more frequently compared with the traditional production, since the DG plants typically use renewable energy sources, like wind or solar power. This means that also the voltages of the network experience the similar changes than the power outputs of the DG plants. Therefore, also the voltage fluctuations in the network are expected to increase.

### **3.2.3. Short-circuit current capacity and protection**

A conductive connection between two live parts of the network causes a short circuit, in which case a short circuit current begins to flow in the network. The current can damage the network components or pose a risk to humans or animals. The magnitude of the current depends on the impedances of the lines, the reactances of the transformers and the short circuit powers of the feeding fault current sources. Respectively, the waveform of the current depends on the types and properties of the feeding generators. In general, it can be said that the short circuit current is the weaker the smaller the cross-sectional areas of the lines are and the further the fault occurs in the network, as long as all the fault current sources of the network are at the beginning of the network, in which case the fault current flows simply from the beginning of the network towards the fault. (Jussila 2002)

A basic requirement for the distribution of electricity is that it must not pose a risk to humans, animals and the environment. For that reason, network protection is used to ensure the safety of electricity distribution in all circumstances, particularly in the fault situations. In addition, the network protection ensures that no damages are caused to the network itself by the faults. Each network company must ensure that both the short circuit protection and earth fault protection of the network are designed so that the network fulfils the company's own safety objectives and especially the current safety regulations and standards that have been imposed by the authorities. The safety standards specify the authorized values for the touch voltages and fault currents in the network as well as for their durations. (Lakervi & Partanen 2009)

The network must also be planned so that the short circuit capacity of the network components is sufficient to withstand all the short circuit currents occurred in the network. Generally, the smaller is the magnitude of the current, and the shorter is the current's impact time, the better the components can withstand the short circuit current. Therefore, the protection of the network must be designed so that it disconnects the short circuit currents fast enough, so that the short circuit capacity of the network is not exceeded. Also, the protection must operate selectively which means that only the protective device closest to the fault location operates and solves the fault.

The adequacy of the network short circuit capacity can be examined with fault current calculations. These calculations are used in planning to determine the most suitable structure of the network and to select appropriate network components and settings for protective devices in terms of short circuit current capacity. In addition, the current capacity must be adequate for all possible connection situations, including all the stand-by supply situations. These short circuit current capacity examinations are being performed every time a new network is being planned. Additionally, the examinations should be performed periodically for the entire existing network. If insufficient part of the network in terms of short circuit current capacity is detected, the network improvements increasing the short circuit capacity should be diagnosed and accomplished. The short circuit capacity of the network can be increased by accelerating the disconnection time of the fault, limiting the fault current or increasing the thickness of the lines. However, increasing the thickness of the lines may cause problems for other parts of the network, as for an example, changing the main line to thicker increases the short circuit currents which may lead to the exceeding of the short circuit current capacity in a branch line. Also, the construction of a new substation may cause similar effects since it increases the short circuit currents. (Jussila 2002) In summary, it can be said that the adequacy of the network short circuit current capacity must be ensured in all locations and all situations in the network and especially after the network improvements have been made.

### **3.2.4. Earth fault protection**

An earth fault is a situation in the network where a conductive connection between a live part of the network and earth is generated. Usually, the earth fault is caused by an arc or contact between a phase conductor and grounded part of the network. The earth fault may cause a touch voltage which can be dangerous for humans. As a result, the earth fault voltages must be limited with earth fault protection. The authorized values for the earth fault voltages are being defined in the electrical safety regulations. The values depend on the earthing conditions of the network, the earth fault current and the duration of the fault current. (SFS 6001 2009)

The earth fault protection can be enhanced by improving the earthing of the network or decreasing the earth fault current, in which cases the earth fault voltage decreases. The earth fault protection can also be enhanced by shortening the tripping time of the earth fault protection, which reduces the impact time of the touch voltage. In Finland, the resistance of the soil is high and, therefore, the earthing conditions are usually always poor. Hence, improving the earthing of the network often requires significant investments in the network, which means that it is not much used in Finland. Consequently, the earth fault protection is usually enhanced by decreasing the amplitude or duration of the fault current. The amplitude of the current can be reduced by using insulated or compensated earthing method. Respectively, the duration of the fault current can be decreased by changing the protection configurations. In addition,

when setting the protection configurations the earthing method must always be considered, because the amplitude of the earth fault current depends substantially on the earthing method. (Lakervi & Partanen 2009; Jussila 2002)

### **3.2.5. Mechanical condition**

The mechanical condition of the network has a significant impact on the continuity of electric supply because the mechanical failures of the network components usually cause fault situations and outages in the network. Therefore, it is important to take the mechanical condition of the network into account in network's general planning.

The mechanical condition of the network may force network operators to renew their networks before the electrotechnical boundary conditions are met in order to guarantee the reliability of the network. Hence, the condition monitoring of the network components is important in network planning and operation, especially for the most stressed components like wooden poles, isolators and disconnectors. The general planning of the network should be executed so that both the mechanical and electrotechnical conditions of the network are considered. This is done by executing network renovations resulting from both the poor mechanical and electrotechnical conditions of the network co-ordinately and simultaneously. For instance, if the poles of the overhead lines are replaced due to the poor mechanical condition, it might be cost-effective to replace the wires simultaneously even though it would not be electrotechnically necessary. (Jussila 2002)

### **3.2.6. Quality of supply**

The appreciation of the quality of electric supply has grown from the perspective of the electric users and, therefore, it has become one of the major boundary conditions of the network planning. The quality of electric supply depends on both the quality of the voltage and continuity of the electric supply. An adequate voltage quality for users is precisely defined in the standard SFS-EN 50160. The standard determines the allowable border values for the amplitude of the voltage, voltage fluctuations, harmonics and etc. These border values must be taken into account in the network planning. (SFS-EN 50160 2011)

The continuity of the electric supply determines the reliability of the electric distribution, and it is aimed to improve by legislative actions. The Finnish Electricity Market Act obligates the network operators to pay standard compensations for customers from over 12-hour interruptions. The compensation is paid depending on the duration of the interruption, but the maximum compensation for one user is 700 euro per year. (Energy Market Authority 2007)

In addition, the continuity of the electric supply is also emphasized by Energy Market Authority regulation model, which determines the allowed profit for the network company. The regulation model works so that the allowed profit is the bigger

the higher is the reliability of the electric distribution. The Energy Market Authority regulation model is further discussed in Chapter 3.5. (Energy Market Authority 2011)

The quality of the electric supply can be improved in several ways, for example, by reinforcing the network, adding circuit breakers and disconnectors to the network or reducing the failure rate of the network. However, all of these methods require financial investments in the network, which reduces the economic efficiency of the network. Therefore, the optimum conditions between quality and economic efficiency must be found in the network planning.

### **3.2.7. Environmental issues**

The environmental impacts of the electrical networks can be divided into ecological impacts and impacts associated with landscape. The ecological impacts are impacts that affect on the surrounding environment of the network, such as humans, animals and plants. For example, when a new power line is constructed, it causes changes to the surroundings of humans and animals. Also, the direct impacts of the power network, such as the effects of the electric and magnetic fields on humans, animals and other electric devices, are included in the ecological impacts. The impacts associated with landscape are impacts that cause damage mainly to the satisfaction of humans. This is mainly due to the fact that the power lines are perceived as ugly in terms of a landscape and view. (Jussila 2002)

In addition, the space requirements of the networks can be considered as an environmental issue because they are significantly affected by the environment. Particularly, in the urban networks the available construction space often dimensions the planning of the network significantly. (Jussila 2002)

The role of the networks' environmental impacts in the network planning is growing and, therefore, more attention has been paid to reducing the impacts. The ecological impacts can be prevented by selecting line routes so that they cause minimal changes for the nature. Also, preventing transformer oil from leaking to the ground in case of a transformer breakdown is important, especially in the groundwater areas. The effects of the electric and magnetic fields can be mitigated by using metal barriers or cases or using cables or PAS lines instead of overhead lines, in which case the generated fields abate effectively. The network's impacts on the landscape can be decreased also by using cables or PAS lines and by selecting line routes appropriately. (Jussila 2002)

The implementation of the environmentally most favourable network is usually not economically feasible, which means that the economic efficiency of the network decreases when the environmental impacts are being reduced. Consequently, the relationship between economy and environmental friendliness must be defined in the network planning.

### 3.3. Planning tools

The most important planning tools of network planning are different information systems of which the most significant is the network information system (NIS) which includes information about the network components. The NIS can be used to perform network calculations which will provide information about the electrical condition of the network and realization of the boundary conditions. The information is used as a basis of the network planning. (Lakervi & Partanen 2009)

Other important information systems for the planning are customer information system (CIS) and maintenance information system (MIS). The CIS contains all information about customers, for example, customer type, customer's energy consumption and customer's billing information. This information can be used in the network planning to determine the demand for electricity in the certain area. The MIS includes the condition information of the network components that can be used to determine the components and parts of the network that require renovations. In many cases, the MIS is included in the NIS. (Jussila 2002)

In addition, one important issue is the planning strategy of the network company. The planning strategy determines the principles and boundary conditions that are used in network planning. Moreover, the planning strategy ensures that the reliability, power quality and environmental impacts of the network are at optimal levels at the same time with network economy. These optimal levels depend on which values and boundary conditions the company appreciates in its planning strategy. (Vierimaa 2007)

### 3.4. General planning of HVDNs

As was stated in Chapter 3.1, the general planning of the HVDNs is a mixture of the transmission network planning and the MVDN planning since the HVDN planning contains elements from both. In Finland, the HVDN network operators usually carry out the general planning of the HVDNs in cooperation with the transmission network operator, Fingrid, since the general planning of the HVDNs is based on Fingrid's regional network planning.

The term regional network planning comes from the fact that Fingrid has divided the Finnish power transmission system in 13 separate planning regions based on the geographical and electrotechnical conditions, and the planning of the network is done independently in each of these regions. However, the plans are based on the Fingrid's long-term transmission network development plan and, thereby, also on the Ten-Year Network Development Plan of the ENTSO-E. The main focus of the Fingrid's regional network planning is on the planning of 110 kV and 220 kV transmission networks owned by Fingrid, but the planning also takes into account 110 kV networks owned by other operators than Fingrid. The time span of the regional network planning is normally 15-20 years and the plans are updated every 3-5 years. The planning is based on the national electricity consumption forecasts and electricity consumption and

generation forecasts and measurements which have been obtained from the local network companies, producers and industry. In addition, the needs of network condition management and operation are considered in the regional network planning. Usually, the planning includes meetings involving Fingrid and all or part of the network operators of the planning region, who own some HVDN. These meetings help to take into account the interests of all stakeholders in the development and planning of the HVDNs. Moreover, Fingrid can receive feedback from the other network operators and the operators can declare the planning needs of their own HVDNs to Fingrid through the meetings. The initiative for the meetings can become from either party. (Reilander 2012a; Reilander 2012b)

Fingrid completes the planning of the networks with its network calculation model which includes the entire Finnish 110 kV, 220 kV and 400 kV networks. The calculation model is also used in interaction with the HVDN network operators to facilitate the HVDN network planning, especially to determine the suitable network protection settings in the HVDN or to verify the functioning of the new HVDN network plans. (Bastman 2011, Reilander 2012a; Reilander 2012b)

The planning criteria of 110 kV networks are usually not as tight as the criteria of 400 kV transmission networks. This is due to the fact that the N-1 criterion must be realized completely in 400 kV networks and, therefore, the network must withstand any single fault that is being occurred in the network. On the contrary, 110 kV and also 220 kV networks must only withstand any single fault without it causing overload to the network or the fault is spread. Hence, a fault can cause a regional interruption in 110 kV network. In addition, the dimensioning factor in 110 kV network is usually the thermal capacity or the short-circuit current capacity of the lines or the voltage drop in the network. In some special cases the dimensioning factor of 110 kV network can also be the stability of the network. (Reilander 2012a; Elenia Verkko 2012)

The planning of the HVDN is somewhat more complicated than the planning of the MVDN, since the HVDN planning requires close cooperation between the transmission network operator, network companies and significant network users. Additionally, the Finnish legislation affects on the HVDN planning because the construction of the line with voltage at least 110 kV requires a construction permit from the Energy Market Authority. Moreover, the network companies do not have a monopoly on the construction of 110 kV network in their own area, as they have in the case of the MVDN. Therefore, the construction needs of new 110 kV lines must be justified for the Energy Market Authority, which will ultimately decide which of the lines will be built. (Energy Market Authority 2010a)

In conclusion, it can be said that, in Finland, the planning of all 400 kV, 220 kV and 110 kV networks, including HVDNs, is generally performed by Fingrid. This is largely due to the fact that the functionality of the majority of the HVDN plans must be verified and accepted by Fingrid before implementation. Also, all the switching changes in the HVDNs must be accepted by Fingrid. Therefore, the majority of the network companies, who own HVDN, do not perform the network calculations required in the



HVDN planning by themselves, since the similar calculations are performed by Fingrid anyway. Instead, the companies usually acquire the calculations as a service from Fingrid, who does not charge any additional fees from the calculations and planning. Especially, the planning of HVDN protection settings is normally always performed by Fingrid, because it requires the use of the Fingrid's calculation model. Moreover, at the moment the HVDN companies think that the changes in the HVDNs will be relatively small, so the planning and calculations need to be performed quite rarely. However, the increasing amount of wind power connected to the HVDN is expected to change the case in the future. Consequently, the investments in the HVDNs may increase in the future and increase the need for the planning of the new HVDN. This may lead to the situation where the resources of Fingrid are no longer sufficient to manage the calculations of the entire 110 kV network. (Bastman 2011, Elenia Verkko 2012, Reilander 2012b)

### **3.5. Effects of Energy Market Authority regulation model on planning**

In a Finnish electric power system, the distribution network companies have a monopoly on the construction and operation of the MDVN network of their own region. This significantly reduces the competition, especially in the pricing of electricity transmission and distribution. Therefore, the business of the network companies must be monitored in order to prevent the abuse of the monopolistic position. For this purpose, the Finnish Energy Market Authority has developed a regulation model to determine the reasonable pricing of network operations. The regulation model is redefined for each regulatory period, each of which lasting four years, except the first one. The first regulatory period was valid from 2005 to 2007, the second from 2008 to 2011 and the third will be valid from 2012 to 2015.

The regulation model defines a reasonable return for each network company regardless of the voltage levels where the company is operating. The reasonable return is determined differently for a transmission system operator, Fingrid, and distribution network companies. For the MVDN companies as well as for the companies that own some HVDN network, the determination of the reasonable return is described in the document of Energy Market Authority. The document assesses the reasonableness of the pricing of both the electricity distribution network services and high voltage distribution network services. Consequently, the term 'HVDN' has been introduced in this thesis since the term is used in that document. Although the methods have been introduced in the same document for both the HVDN and the MVDN operators, the determination of the reasonable return for the HVDN operators differs slightly from the one for the MVDN operators. This chapter introduces the determination of the reasonable return for the HVDN and MVDN operators and explains the differences between the two cases. (Energy Market Authority 2011)

The reasonable return depends on the capital invested in the network operations and the current value of the company's electricity network, which depends on the size of the network and age, type and life time of the network components. In addition, the reasonable return is affected by a reasonable rate of return for all capital invested in the network, which is determined using the Weighted Average Cost of Capital method (WACC). When the reasonable return has been determined, it is compared with the company's actual adjusted profit. The actual adjusted profit consists of the actual profit of the company added with the effects of incentives that may reduce or increase the actual adjusted profit. The regulation model requires that the actual adjusted profit should not be higher than the determined reasonable return of the company in the long-term. Therefore, the actual profit of the company can be the larger the more effectively the incentives are being fulfilled. (Energy Market Authority 2011)

The incentives in the third regulatory period are the investment, quality, innovation incentive and the incentive to improve efficiency. The incentives are calculated annually. The investment incentive encourages the network company to develop its network and invest in it sufficiently. The investment incentive works in such way that the more the company invests in the network, the greater the company's profit can be. (Energy Market Authority 2011)

The quality incentive aims to improve the quality of the electric transmission and distribution. It compares the company's realized costs of interruptions with the network operator specific reference level and the difference between the figures defines the impact of the incentive, so that the better the quality of the electric supply is, the more profit the company is allowed to generate. The calculations of the company's realized costs of interruptions are different in case of the MVDN and HVDN, since in the case of the MVDN, the calculations take into account both the number and the duration of both the long planned and the long unexpected interruptions as well as the number of both the high-speed automatic and the delayed automatic reclosings, which are short interruptions. On the contrary, in the case of the HVDN, the calculations are affected only by the number and duration of the long unexpected interruptions and the duration of the planned interruptions. The short interruptions do not affect on the incentive in case of the HVDN in the third regulatory period, but the Energy Market Authority begins to collect information about the short interruptions from the HVDN operators with an objective to add the impact of the short interruptions to incentive in the fourth regulatory period. In conclusion, the quality incentive enhances the quality of power delivery in the network planning and encourages improving the quality of electric supply by increasing its economic competitiveness. (Energy Market Authority 2011)

The incentive to improve the efficiency aims to improve the cost-efficiency in the network company's operations. The incentive determines an individual objective to improve efficiency for each network company. For the MVDN operators, the objective consists of a general and company specific objective to improve efficiency; and for the HVDN operators, the objective consists solely of the general objective to improve efficiency. The general objective to improve efficiency aims to encourage all companies

to develop their operations in accordance with the technological development. In the third regulatory period, the general objective to improve efficiency is 2.06 % per year. The company specific objective to improve efficiency aims to enhance especially the cost-efficiency of the inefficient companies. The company specific objective will determine the company's potential to improve the cost-efficiency in relation to the most efficient companies. Thus, the inefficient companies receive greater benefits from the incentive than the most efficient companies and, therefore, the inefficient companies have higher interest to develop their cost-efficiency. (Energy Market Authority 2011)

The incentive to improve the efficiency measures the cost-efficiency of the company with the StoNED method (Stochastic Non-smooth Envelopment of Data). The method compares the potential effectiveness of the company, which has been calculated using the company's company specific objective to improve efficiency, with the realized effectiveness using the costs of cost-efficiency. Therefore, more efficient operation enables taking greater profit. The realized costs of cost-efficiency are affected by controllable operational costs and interruption costs, which affect also on the quality incentive. Consequently, the incentive to improve efficiency also encourages improving the quality of electric supply as well as the quality incentive does. (Energy Market Authority 2011)

A novel incentive in the third regulatory period is the innovation incentive, which aims to encourage the network companies to promote innovative technical and functional solutions in network operations. The company may increase its allowed profit with the innovation incentive by increasing the use of automatic meter reading (AMR) in operation points equipped with a fuse of less than 63 A, or by investing more in general research and development which promotes the penetration of new technology. However, it is only possible to implement the increase in the use of AMR by the MVDN operators, because there are no operation points with a fuse less than 63 A in the HVDNs. Altogether, the innovation incentive promotes the observing of novel technologies in the investments and planning of both networks. (Energy Market Authority 2011)

In conclusion, the regulation model of the Energy Market Authority encourages the network companies to invest and increase the value of their electric networks. In particular, the regulation model emphasizes the investments in the quality of the power delivery since it is enhanced by both the quality incentive and the incentive to improve the efficiency. In addition, the investing in novel technologies is stimulated by the innovation incentive. All in all, the main notice is the fact that the regulation model highlights the role of electric supply's quality as a boundary condition of the network planning.

## 4. WIND POWER AS PART OF HVDC

### 4.1. General

The most important construction criterion of a wind power plant is windiness, as it is the main factor in determining the power generated by the power plant. The wind is distributed unevenly depending on the geographical conditions. Therefore, also the wind plants are typically constructed geographically unevenly so that in windy areas the density of the plants can be considerably high. These areas are typically sparsely populated and, thus, situated poorly in terms of the electric network since the network is often weak and planned to transfer only small amounts of power. Consequently, connecting wind power to the network causes substantial investments, and the aligning of the investments may cause problems for the network companies. The investments consist of the interconnection costs of the wind plant and network, the network reinforcement costs and the costs to increase the reserve capacity of the network. The allocation principles of the investments vary by country. In Finland, the wind producer usually pays the costs up to the connection point, and the network operator, whose network the plant is being connected, pays the required network reinforcements and reserve capacity. (Matilainen 2011)

The connection method of wind power depends on the size of the wind power unit and the type of the surrounding network. Small individual wind power units are usually connected to the MVDC, while the wind farms consisting of several wind turbines are connected to the HVDC or transmission network. This is due the fact that the higher the voltage of the network is, the lower are the power losses, and the better the network stands the major increase in power transfer. Small wind power units can be connected directly to the power network whereas bigger wind farms must be connected via switching station. The network connection voltages and connection methods are defined by interconnection laws and regulations which are discussed in Chapter 4.2.

Currently all over the world, the majority of the research in the effects of wind power on the network is focused on the effects on the whole network while the effects on the HVDCs receive appreciably lower attention (Holtinen et al. 2009; ENTSO-E. 2010; EWEA 2010). Consequently, there is very little research data available on the wind power effects on the HVDCs. However, since a large part of the future wind plants in the network will be connected to the HVDCs, at least in Finland, the wind power effects on the HVDCs should be examined more precisely in the future.

## 4.2. Interconnection laws and regulations

Since the thesis concentrates on the HVDNs, the interconnection laws and regulations in the MVDNs are not being discussed in the thesis. The thesis describes only the interconnection laws and regulations of the HVDNs and transmission networks.

The Finnish transmission system operator, Fingrid, determines the requirements of the network connection. These requirements are defined in Fingrid's connection conditions and technical requirements of the power plants (Fingrid 2007a; Fingrid 2007b). In addition, Fingrid has defined detailed regulations for connecting wind turbines to the Finnish network which are based on Nordel Connection Code for Wind Turbines (Tuulivoimalaitosten järjestelmätekniiset vaatimukset 2011). Nordel was disbanded in 2009, when a new pan-European administrator organization ENTSO-E was established. The ENTSO-E unified all six former TSO organizations including Nordel (Partanen 2011). However, Nordel's code will remain in force in Nordic countries until ENTSO-E publishes its own network code, which will be valid in almost all European countries. The network code of ENTSO-E will be based on currently valid network codes in Europe, so the code will be largely similar with Nordel's code, since it will also provide country specific regulations. (Fingrid 2010)

The Fingrid's regulations are designed to ensure the compatibility and correct operation of the electric networks in all operation conditions. The regulations apply to all kinds of network connections. However, since Fingrid has no contractual relationship with customers outside of the transmission network, the local network operators are responsible for ensuring that the wind farms connected to their network meet the Fingrid's regulations. (Tuulivoimalaitosten järjestelmätekniiset vaatimukset 2011)

The Fingrid's regulations apply to the wind power units whose connection point power exceeds 0.5 MVA. However, for power units with power from 0.5 MVA to 10 MVA, eased requirements are valid. (Fingrid 2011) Since this thesis focuses on the HVDNs and the wind power units connected to the HVDN are usually over 10 MVA units, only the Fingrid's requirements valid for over 10 MVA units are discussed.

The Fingrid's regulations insist that wind farms with power larger than 250 MVA must be connected to 400 kV transmission network and wind farms with power less than 250 MVA can be connected to 110 kV network, as long as the capacity of the network is sufficient. In addition to that, wind farms with power more than 25 MVA must be connected to the network via switching station. On the contrary, wind farms with power up to 25 MVA can be connected directly to the network's power line under certain conditions determined by Fingrid. (Fingrid 2012)

Moreover, Fingrid will charge a connection fee from the power plants that are connected to its network. Fingrid has just introduced the new practises for connection fees in its networks. The connection fees of Fingrid have been listed in Table 4.1.

**Table 4.1.** *The connection fees of Fingrid. (Fingrid 2012)*

<b>Connection method</b>	<b>Connection costs M€</b>
Connection to the existing 400 kV switching station	2.0
Connection to the existing 220 kV switching station	1,2
Connection to the existing 110 kV switching station	0,6
Connection to 110 kV power line	0,5

In addition to the Table 4.1, if the connecting of the plant to the network requires the construction of a new switching station, all the construction costs of the station will be collected from the connecting party. However, if more connections will be built into the constructed station in the first ten years, Fingrid will compensate the construction costs of the station minus the currently valid connection fee from connecting to the existing switching station. In addition to the connection fees, the connecting party is responsible for all the costs until the connection point of the Fingrid's network, such as the construction costs of the internal lines and transformers of the wind plant. Respectively, Fingrid is responsible for all the necessary reinforcements caused by the wind plant to the elsewhere in the network. (Fingrid 2012)

As can be seen from Table 4.1, there is not that much difference in the connection fees to the existing 110 kV switching station and to 110 kV power line. However, according to the Fingrid's regulations, the 110 kV power line fee only allows that a power plant with power not exceeding 25 MVA can be connected to 110 kV power line. While, the 110 kV switching station fee allows to connect a power plant with power up to 250 MVA to the existing switching station. The difference between the allowed connection powers is remarkable, wherefrom can be detected that it is Fingrid's objective that at least the large wind plants will be connected to the switching stations instead of directly to 110 kV power lines. In addition, while Fingrid has the connection fees for the plants, the HVDN operators are free to decide the connection fees in their own HVDN. At least one HVDN operator does not charge additional fees from connection to its HVDN (Elenia Verkko 2012).

The Fingrid's regulations for connecting wind turbines to the Finnish network are mostly identical with Nordel's code, which is valid throughout the Nordic countries. The regulations require certain technical characteristics from interconnected wind turbines. Firstly, the maximum active power of the wind plant must be adjustable in range of 20 % - 100 % of the turbine's nominal power with accuracy of at least 1 MW. The adjusting must be able to be performed remotely and it must include an automatic frequency adjustment option. Also, the rate of change of the active power production must be controllable so that the rate of change upwards must not exceed 10 % of nominal power per minute. Furthermore, due to the correct operation of the network protection, it must be possible to reduce the active power from 100 % to 20 % of nominal power in 5 seconds without disconnecting the wind plant from the network. (Tuulivoimalaitosten järjestelmätekniset vaatimukset 2011; Nordel 2007)

Secondly, the wind plant must have adequate reactive power capacity and it must be adjustable automatically, so that the plant can participate actively in voltage control. (Tuulivoimalaitosten järjestelmätekniset vaatimukset 2011; Nordel 2007) The wind plant must be able to operate continuously with its nominal power output when power factor is not exceeding (Tuulivoimalaitosten järjestelmätekniset vaatimukset 2011):

- 0.95 ind and network voltage is 90 % - 100 % of nominal voltage
- 0.95 cap and network voltage is 100 % - 105 % of nominal voltage

These reactive power capacity requirements are valid at the so called VJV reference point defined by Fingrid. In the HVDNs, the VJV reference point is usually at the 110 kV busbar of the wind plant's own transformer (VJV-vaatimusten referenssipisteen määrittelyperiaatteet 2011). For over 10 MVA wind plants, a reactive power capacity calculation must be performed and then approved by Fingrid, at the planning stage of the plant. (Tuulivoimalaitosten järjestelmätekniset vaatimukset 2011)

Thirdly, the wind power plants must have automatically operated voltage and reactive power control, which enables the control of the reactive power flow at the VJV reference point. The reactive power capacity of the wind plant must be available for the control. Moreover, the response of the control must be stable to voltage changes in the network and the control must not cause recurrent or large fluctuations in the reactive power of the wind plant. (Tuulivoimalaitosten järjestelmätekniset vaatimukset 2011)

The voltage and reactive power control of the over 10 MVA wind plant must be able to operate in three different ways, and the control range must match the reactive power capacity of the plant. Firstly, the control must be able to operate as constant reactive power control, which means that the reactive power input or output of the VJV reference point can be determined directly with the control. Secondly, the control must be able to operate as constant power factor control, so that the power factor of the VJV reference point can be kept at a constant value. This means that the reactive power input or output of the plant varies as a function of the real power output of the plant. Thirdly, the plant must be able to operate as constant voltage control, which means that the voltage at the VJV reference point is being kept at constant value with the reactive power capacity of the wind plant. This means that, if the voltage at the VJV reference point is under the desired value, the plant increases its reactive power production. On the contrary, the plant begins to consume more reactive power, if the voltage at the VJV reference point is over the desired value. (Tuulivoimalaitosten järjestelmätekniset vaatimukset 2011) Fingrid typically wants that the voltage and reactive power control of the wind power plant is implemented with the constant voltage control (Kuusela 2012).

As regards to the voltage and frequency of the network, the wind plant must be able to operate in the situations presented in Figure 4.1.

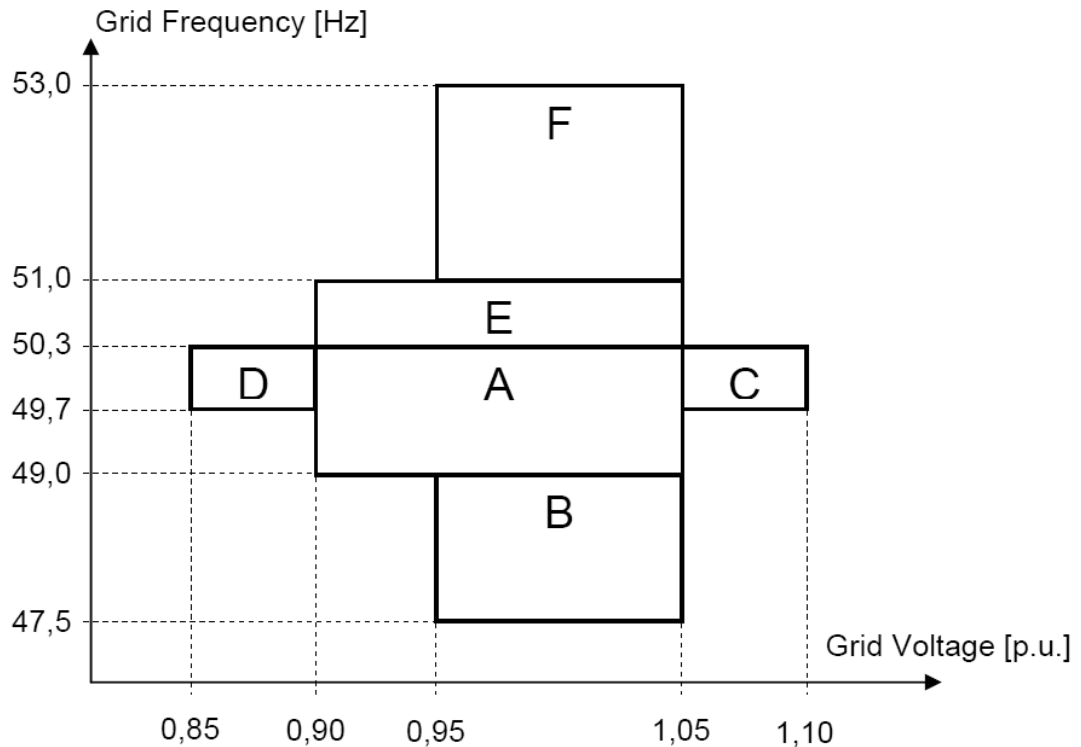

**Figure 4.1.** The requirements of the wind plants related to voltage and frequency. (Nordel 2007)

When the voltage and the frequency are within the rectangular areas shown in Figure 4.1, the requirements of Table 4.2 applies. The nominal grid voltages of 400 kV, 220 kV and 110 kV networks in Finland are 400 kV, 233 kV and 118 kV, respectively (Tuulivoimalaitosten järjestelmätekniset vaatimukset 2011).

**Table 4.2.** Requirements related to the areas of Figure 4.1. (Nordel 2007)

Area	Requirement
A	Normal continuously operation. No reduction in active or reactive capability is allowed due to system voltage and frequency.
B	Uninterrupted operation in minimum 30 minutes shall be possible. The active output is allowed decreased as a linear function of the frequency from zero reduction at 49.0 Hz to 15% reduction at 47.5 Hz.
C	Uninterrupted operation in minimum 60 minutes shall be possible. The active output may be reduced 10%.
D	Uninterrupted operation in minimum 60 minutes shall be possible. The active output may be reduced 10%.
E	Uninterrupted operation in minimum 30 minutes shall be possible. The possible active output is allowed to be slightly reduced. (The total duration of these operating conditions is normally not more than 10 hours per year).
F	Uninterrupted operation in minimum 3 minutes shall be possible. The active output may be reduced to any level, but the turbines must stay connected to the system.



In addition, the regulations demand that the wind plants must possess fault ride-through (FRT) capabilities, which means that the wind plants must be able to continue operation during and after disturbances in the network. Also, the wind plants must maintain the operation during and after dimensioning faults in the Nordic transmission system. More precisely, over 10 MVA wind plants must stay connected in the power system, when the voltage at the VJV reference point is above the levels shown in Figure 4.2. (Tuulivoimalaitosten järjestelmätekhniset vaatimukset 2011; Nordel 2007)

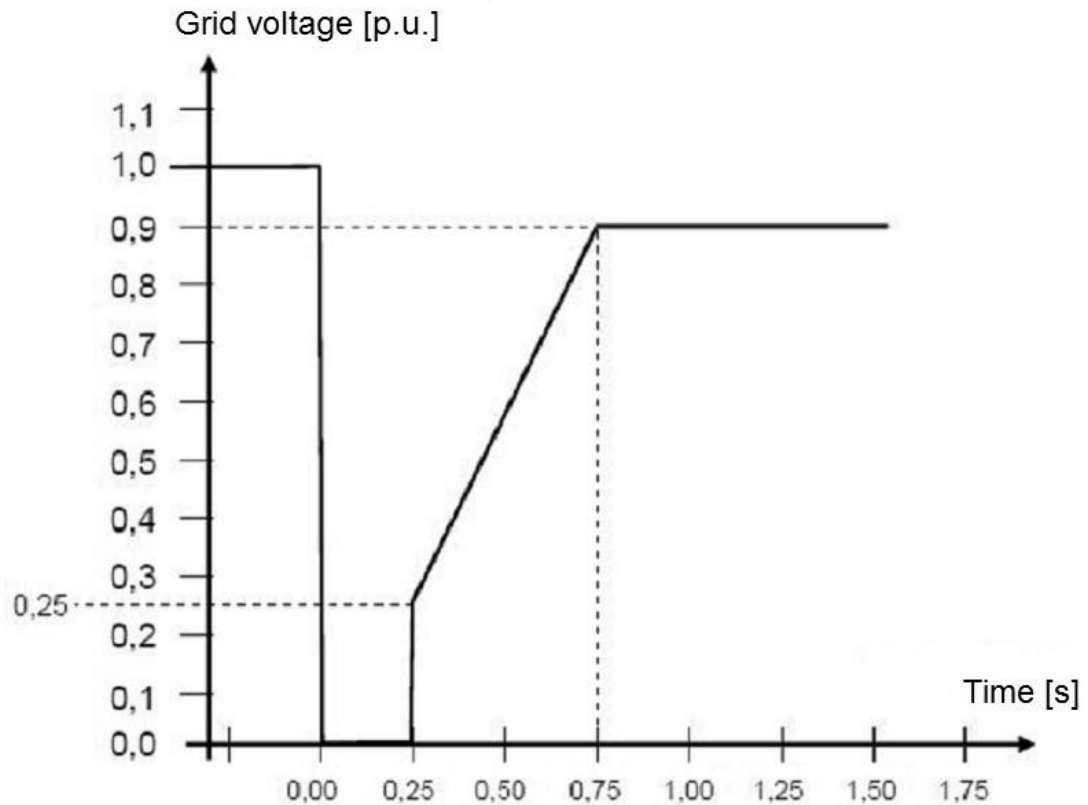

**Figure 4.2.** The voltage dip profile which wind plant must withstand without disconnecting from the network. (Nordel 2007)

As can be seen in Figure 4.1 and 4.2, the wind farms should withstand relatively large voltage and frequency fluctuations and even operate at zero voltage for 0.25 seconds, which means that the requirements for over 10 MVA wind plants are very strict. However, the strict requirements prevent the farms from disconnecting from the network and, thus, guarantee the reliable operation of the network in all circumstances, including in major fault situations.

The wind plant must have communication with the control room of the network operator, so that the plant is remote-controlled and can be disconnected from the network in case of certain faults. Thus, the generation of the undesirable islands in the network is being prevented in the fault situations, where the wind plant might be able to maintain the voltages in the network behind the fault point. (Reilander 2012b) In

addition, the starting of the wind plant must not cause any significant harmonics or voltage fluctuations that are over 0.03 pu to the voltage of the VJV reference point. Also, the wind turbines of the wind farm must not stop at the same time due to high wind speed, but the stop must be graduated. Furthermore, the calculation models of the wind plant must be submitted to the Fingrid, who uses the models in measures related to the planning and operation of the network. (Tuulivoimalaitosten järjestelmätekniset vaatimukset 2011)

As it was stated above, ENTSO-E is currently preparing new connection requirements which are applicable to all generators. The process is currently at the draft stage, and the novel code will replace the currently used network codes in 2013 at the earliest. The requirements of ENTSO-E will include country specific requirements, which will be based on the currently used regional requirements, such as Nordel's grid code. On the basis of the published drafts of ENTSO-E, the requirements will be slightly stricter than in Nordel's code, especially for voltage dips and frequency fluctuations. Also, the requirements of ENTSO-E demand that the wind plants participate even more rapidly in voltage support and control by their reactive power production and consumption. Moreover, the transmission system operator will have the right to demand temporarily higher active power production than nominal from wind plants. In addition, the requirements will depend more on the size of the power plant unit, because the plants are being divided into four groups according to size and the requirements will vary by group, so that the largest plants have the highest requirements. (ENTSO-E 2011)

### **4.3. Network effects of wind power**

Connecting wind power to the electric network causes several effects on the network. These effects can be divided into local and system-wide effects, depending on their area of impact, and into short-term and long-term effects, depending on the time-scale of the effects. The time-scale of the short-term effects is from a few seconds to hours and the time-scale of the long-term effects is from months to years. All of the effects are not negative, as some of them may be beneficial for the network. Moreover, the penetration level of wind power in the network defines the tone of the effects since the effects typically change to more and more negative as the penetration level increases. All in all, it can be said that the effects of wind power are perceived largely as negative. (EWEA 2005; EWEA 2010)

#### **Local effects**

The greatest local network effects of wind power are targeted to the network voltages and power quality, because wind plants increase the network voltages in the vicinity of their connection point. The time-scale of these effects is from a couple of seconds to minutes. The main impact of the effects is the fact that they complicate the voltage

control of the network, as the network voltages near the wind plants may rise above the boundary conditions during windy conditions, while the voltages in the adjacent feeder may be close to the lower limits due to heavy load. However, the voltage control of both feeders is typically combined, which means that in this case the voltage control of the network is unviable due to the large difference between the feeder voltages. (EWEA 2005)

In addition, the voltage fluctuations of the network can increase locally due to the high production variations of the wind plants. This is because the power production of the wind plant depends greatly on wind speed, which is characterized by high and fast fluctuations. Whenever the wind speed changes from strong wind to weak or from strong wind to stormy wind, which leads to the disconnection of the plant for security reasons, the output power of the wind plant changes rapidly from nominal power to zero. Since the power flows in the network affect on the voltages of the network, the voltage at the connection point of the plant will also experience a change when the output power of the plant changes. These voltage fluctuations may exceed the allowed values unless they are being limited. (Mäki 2011)

The wind plants also affect on the network's power quality by increasing voltage transients and harmonics in the network. The voltage transients are generated mostly when generators or capacitors are connected to the network. The capacitors are used in some cases to compensate the reactive power needed by the plants, so that the reactive power flow at the connection point of the plant is minimized. Respectively, the increase in the harmonics results from the fact that the converters of the wind plants produce the variety of harmonics in the network. The amount of the harmonics depends on the type of the wind plant concept and converter. The harmonics cause resonances to the network, increase the network losses and complicate the operation of motors and generators. (Mäki 2011)

On the other hand, the wind plants can also influence the network voltages and power quality positively. Firstly, the voltage rise caused by the plant can also be utilized by placing the connection point of the plant in an area where voltage is generally lower, for example, in the area where significant power is transferred through a long power line. Therefore, by placing the wind plant in the area, the power transmission and voltage drop of the line will be reduced and, thus, the voltages in the area will be increased. Secondly, the power quality of the network can be improved with wind plants by accepting only wind plants that completely meet the newest interconnection laws and regulations of the plants. In this case, the wind plants can participate actively in network's voltage control, support the network voltage and reduce the voltage fluctuations. (EWEA 2005)

In addition to these, the high production variation and challenging predictability of the wind plants cause other effects on the network such as effects on the network efficiency. The high variation in the production of the wind plants means that the network power flows vary widely, which causes difficulties for the network dimensioning. These effects can be categorized either as local or system-wide effects,

since the wind plants affect on the network's power flows broadly. The effects cause additional investments for the network operators, because of the difficulties in the network dimensioning, as the network components must be oversized due to the changing power flows. In addition, the change in the power flows due to the wind plants may increase the power losses of the network locally or system-widely, which also causes economic losses for the network operators. (EWEA 2005)

On the contrary, the changes in the power flows caused by the wind plants might also affect positively on the network efficiency, for example in the situations when there is a significant amount of load close to the connection point of the wind plant. In this case, the magnitudes of the power flows in the network would be decreased, which means that also the power losses of the network would be reduced. (Mäki 2011)

### **System-wide effects**

The greatest system-wide effects of wind power are caused by the high production variation and unpredictability of the wind power production. These effects affect on the regulation reserves, system production and transmission adequacy and production efficiency of the network in both the short-term and long-term scale. Firstly, the regulation reserves, the production and transmission adequacy of the network must be at a sufficient level to ensure the balance between production and consumption in the system, especially in situations when there is no wind. Consequently, wind power may cause additional investment needs to maintain a sufficient level of system adequacy and regulation reserves in the network. Moreover, the unpredictability of wind power may decrease the production efficiency of the other production forms, such as thermal and hydro power, since the planning of the production unit commitment is more difficult with variable wind power in the network. (EWEA 2005)

## **4.4. Wind power effects on network planning**

The increase in the amount of wind power in the network causes several effects on the network planning. Most of these effects are caused by the high variability of wind and wind power production. The effects require special attention in the network planning to ensure the reliability, safety and cost-effectiveness of the network in the future. The effects are usually perceived as negative for the network, but some of them may also be beneficial from the network's point of view.

The increase in the number of wind power increases uncertainty in the network general planning, since the realization probabilities of the announced wind power projects are difficult to estimate. The realization of the projects is the easier to evaluate, the closer the realization point of the project is. Therefore, the increase in the wind power production will probably require the average time span of the network general planning to be shortened, so that the evaluation of the realization would be more accurate.

In addition, the voltage rises and fluctuations caused by wind plants should be taken into account in the network planning because they affect on the dimensioning of the network significantly. The network planning should ensure that the network voltages and voltage fluctuations can be kept within the limits defined by the authorities under all circumstances. Exceeding the limit values leads to a need for the strengthening of the network and investments in the network, which increases the additional costs of wind power for the network. (Mäki 2011)

Traditionally, the dimensioning situation in the network has been the situation of maximum consumption and minimum production, since in this situation the power flows in the network are at their highest and, thus, the voltages of the network are at their lowest due to the high voltage drops. However, the increase in the connection of the production to the HVDC and MVDC changes the case so that also the situation of the minimum consumption and maximum production must be considered in the network planning and dimensioning. This is because the voltages and voltage fluctuations of the network may rise above the limits due to the increased amount of DG, such as wind plants, as was also described in Chapter 4.3. (EWEA 2005)

On the contrary, as stated in Chapter 4.3, the voltage rise caused by a wind plant may be beneficial for the network planning, since the modern wind plants can participate in network voltage control, increase the fault current levels and support the voltage, even when there is no wind. Therefore, the wind plants can also be used in the network planning to strengthen the network and reduce the investment needs resulting from low network voltages. (Mäki 2011)

Additionally, since the wind plants affect substantially on the power flows of the network, the adequacy of the network's power transmission capacity must be ensured in all wind and load conditions. Because the wind plants may increase the load or fault currents in the network, the network planning must ensure that the thermal capacities of the power lines and other network components, such as transformers, should not be exceeded in either situation.

On the other hand, as said in Chapter 4.3, the wind plants may decrease the power flows and currents in the network, if they are situated near the consumption points. On the basis of this, the wind plants may increase the transmission capacity of the network in some situations, if the planning of the network connection points of the plants is being performed properly.

The high variability of the wind power production also affects on the needed amount of the active power regulation reserves in the network, since in case of no wind the reserves must be able to replace the power produced by the wind plants. The mission of reserves is to take care of the active power balance in the network and, hence, manage the frequency control of the network. Wind power increases the need for regulation reserves in the network because the power variations are increased due to the variability of the wind. (EWEA 2005) However, the need for regulation reserves could be potentially handled and reduced by using DSM system-widely, in which case the loads of the network could be reduced in the case of no wind.

The amount of needed new regulation power to the network due to wind power is difficult to estimate, since the implementation of the wind plant projects is challenging to forecast. Fingrid is responsible for the frequency control of the Finnish electric power system and, therefore, the wind power effects on the network reserves are mostly concerns of Fingrid.

The variations of wind power increase mainly the need for reserve power in secondary or tertiary control time scales, which means that the reserve power can be acquired from the balancing market. This reduces the construction needs of the reserve power plants and, thus, also the additional balancing costs caused by wind power. In addition, the need for the reserve power and the additional balancing costs depend highly on the penetration and geographic distribution of the wind power, as well as the flexibility and adjustability of the production methods of the system, the deadlines of the electricity market offers and accuracy of the wind power production forecasts. Therefore, more attention in the network planning should be paid on these issues, especially by Fingrid, if the penetration of wind power in the network increases. (EWEA 2005)

All in all, most of the wind plants' effects on the network planning cause additional investments in the network and, therefore, reduce the cost-effectiveness of the wind power. These costs can be, for example, additional balancing costs due to the increased need for reserve capacity or additional investment costs resulting from the strengthening of the network. On the contrary, in some cases by connecting wind plants in the network the investment costs can be avoided or reduced by, for example, reducing the overall power flows in the network. In addition, novel functional tools are needed in the planning and operation of the network to evaluate these costs and the effects of wind power on the different types of networks. In conclusion, the network planning and operation should take into consideration all the specific characteristics of the wind plants and the wind plants should be connected to the network so that the cost-effectiveness and reliability of the network are optimized while the safety of the network is not jeopardized.

#### **4.5. Wind power effects on network operation**

The increase in the amount of wind power in the network must be also considered in the network operation, because the wind power plants increase problems and affect on the network operation considerably. However, as in the case of effects on the network planning, the effects of wind power on the network operation can be either positive or negative. In addition, the effects are mainly caused by the same wind power characteristics as in the case of network planning, the variability of the wind power production being the greatest.

The effects of wind power on the network operation can affect on the network on two different levels: locally or system-widely. Moreover, some of the effects may affect on the network both locally and system-widely. The system-wide effects of wind power

affect mainly on the activities of Fingrid since it is responsible for the functionality of the whole Finnish electric power system. Therefore, mostly the local effects of wind power affect on the operation of the HVDN. Since this thesis concentrates on the planning and operation of the HVDN, the main focus of the Chapter is on the local effects of wind power on the network operation. However, the system-wide effects are being briefly introduced before proceeding to the local effects.

### **System-wide effects**

All the most significant system-wide wind power effects on the network operation are caused by the variability and unpredictability of the wind power production. The magnitude of the system-wide effects depends greatly on the penetration level of the wind power production in the network, as the effects will become increasingly serious, when more wind power is being connected to the network. However, the tone of the effects depends significantly on the geographical distribution of the plants, because if the plants are geographically decentralized, the variability in the production is being compensated and reduced due to the fact that certain wind conditions prevail in different areas at different times. In other words, even if some of the wind plants in the certain area of the network are stalled because of too low or high wind, still the wind plants in the other areas are usually generating power. Thus, the situation, when all wind power production of the network is stalled, is extremely unlikely. (EWEA 2005)

Due to the uncertainty and difficulty in the forecasting of the wind power, the amount of needed system-wide regulation reserves for network power balancing is increased, which increases the balancing costs of the network. Also, the power fluctuations within the power network and between interconnected networks are increased due to the same reason. In addition, the uncertainty and difficulty may result in that the wind power production may have to be curtailed in some situations, if the consumption or transfer capacity of the system is not adequate. This is not desirable, because when the wind production is curtailed, a proportion of the wind energy is wasted, since in such case all the available energy form wind is not used in electric power production. The curtailing of the wind production reduces the cost-effectiveness of the power production and network. (EWEA 2005)

The increase in the balancing reserves and in the needed transfer capacity due to wind power and the curtailing of wind power in the system-wide scale might possibly be avoided or decreased by improving the forecasting of the wind power production generally, by ensuring adequate transfer capacity in the network and especially between interconnected networks, by using DSM in the network or by changing the operation of the electricity market so that the closure times of the market are being reduced. Especially, the latter would effectively reduce the uncertainty of the wind production, since the wind power forecasts would become more and more accurate if their time interval was shortened. (ENTSO-E 2010)

Another major system-wide effect of wind power is the effect of wind power on system stability. Traditionally, wind plants have been designed in such way that they are disconnected from the network in the event of disturbance or fault. This approach decreases the stability of the network and, therefore, it is functional only when the amount of wind power in the network is relatively small, since it also increases the risk for a major disturbance in the network. Consequently, since the penetration levels of wind power in the networks are growing, in order to maintain the current level of network stability, the behaviour of the wind plants during the faults should be changed. Therefore, the network operators have begun to require stricter laws and regulations for connecting wind plants in the network, for example FRT capabilities. (EWEA 2005) These regulations were discussed in Chapter 4.2. All in all, more studies are needed to diagnose the effects of wind plants on the system stability; however, some studies indicate that when the connected wind plants meet the latest requirements, the overall stability of the network can be even improved with wind power (Piwko et al. 2005).

### **Local effects**

As it was stated above, primarily only the local effects of wind power affect on the operation of the HVNDs. However, some of the system-wide effects of wind power on the network operation can be rendered as local, for example, the impacts on the network's transfer capacity or power fluctuations also influence the network locally. The most significant locally affecting effect of wind power is the increase in power fluctuations due to the variability in the production of the wind plant. The increase causes the same effects locally as it causes system-widely. Firstly, the adequacy of the network transfer capacity may be compromised, which means that additional investments in the capacity may become mandatory. Secondly, voltages in the network vary depending on the power flows in the network, which means that the voltage fluctuations in the network increase and may exceed the allowable values imposed by the authorities. Thirdly, the power flows in the network affect on the network power losses, which means that the magnitude of the power losses in the network may change as the power flows of the network change. This means that more attention should be paid in the network operation to the optimization of the losses in the network. In addition, the increased power fluctuations in the network may lead to the curtailment of the wind power production, if the wind plants generate more power than what can be transferred and consumed in the network. (Mäki 2011)

Other considerable local effect of wind power is an increase in the complexity of the network protection, which occurs if the protection of the network has been designed assuming that the power flows in the network are unidirectional. However, since the protection of the transmission network and most of the HVNDs is implemented by distance or differential relays, this effect should only have a little impact on these networks. On the other hand, the impact on the MVDN is significant and, thus, the operation of the MVDN protection must be modified so that it will be able to handle



multidirectional fault currents and take into account the fault current sources all over the network. (Mäki 2011)

Generally, the wind power effects on the network operation can be managed by increasing the intelligence of the network, in other words, increasing automation in the network and communication between power plants, network components and loads. Thus, the power flows of the network could be better monitored and controlled and the power flow variations would be reduced. Moreover, the intelligence in the network protection would help the protection to cope with multidirectional fault currents. In addition, with distributed wind plants and adequate intelligent network operation, controlled islands could possibly be formed in the network in fault situations. This means that the voltage can be maintained in the part of the network behind the fault, which means that the disturbance area of the fault would be smaller and, consequently, the reliability of the network would be increased. (Mäki 2011)

## 4.6. HVDN network simulations

This thesis includes HVDN simulations which have been carried out with the network test system. The network test system has been introduced in Chapter 2.4.1 and in Appendix 2. The structure of the test system has been presented in Figure 2.3 and Appendix 1. The main purpose of the simulations is to identify the effects of variable wind production on the HVDN planning and operation and, in addition, to clarify the benefits of DSM for the planning and operation.

The simulations have been performed with three different network cases regarding to the lengths of the network lines, as it has been said in Appendix 2. However, only some of the lengths vary case by case, as can be seen from Table A2.3.

In Case 1, the lines of the network are the longest. In this case, Lines 11-15 and 12-16, which are the lines that are connected to the 110 kV busbars of the 400/110 kV transformers, are 60 and 100 km long, respectively. Moreover, Lines 11-14 and 12-13, which are the lines that connect the wind farms to the 110 kV busbars of the 400/110 kV transformers, are 70 and 110 km long, respectively. Lines 14-15 and 13-16, which are the lines that connect the wind farms to the 110 kV substations further in the network, are both 30 km long. All in all, Case 1 models the situation, where the locations of the wind farms are near the existing 110 kV substations, but almost as far from the 400/110 kV substations than the locations of the 110 kV substations are.

In Case 2, Lines 11-14 and 12-13, which connect the wind farms to 400/110 kV substations, are 50 and 70 km long. Other lines of the test system in Case 2 are identical with Case 1. Case 2 has been thought to model the situation, where the wind farms are located closer to the 400/110 kV substations than in Case 1, but the wind farms can still be connected to the 110 kV substations with 30 km lines, as in Case 1.

In Case 3, Lines 11-14 and 12-13, which connect the wind farms to the 400/110 kV substations, are 50 and 70 km long; and Lines 11-15 and 12-16, which interconnect the 400/110 kV and the 110 kV substations, are 50 and 70 km long, respectively. This

means that both lines that are connected to the same 400/110 kV substation have the same length. Lines 14-15 and 13-16 that connect the wind farms to the 110 kV substations (Buses 15 and 16) are only 10 km long. Case 3 models basically the same situation as Case 1, where the locations of the wind farms are near the existing 110 kV substations, but almost as far from the 400/110 kV substations than the locations of the 110 kV substations are. However in Case 3, all distances of the test system are significantly smaller than in Case 1.

As can be seen in all cases, the distances between the wind farms and the 110 kV substations from the 400/110 kV substations are larger in the right branch of the 110 kV network of the test system than in the left branch. This has been done in order to simulate and model the effects of the various network lengths on the results.

In addition to the line lengths, the loads of the network are varied in the simulations. There are two different load situations in the network test system, as it has been said in Appendix 2, the maximum and minimum load situations. The maximum load situation is a situation with a total load of 300 MW and 45 MVar. On the contrary, the minimum load situation is a situation with a total load of 22.1 % of the maximum, which means that the total load of the test system is 66.4 MW and 10 MVar. The maximum load situation has been presented in Figure 2.3 and the minimum load situation in Appendix 1.

#### **4.6.1. Network capacity**

The first task of the simulations is to determine how much wind power can be connected to the test system and, therefore, the maximum amount of wind power, which can be connected to the test system under certain conditions, has been calculated. The simulations have been performed for all three line length cases with both maximum and minimum load situations. The results of the simulations have been presented in Appendix 3 in Tables A3.1, A3.2 and A3.3.

In addition, the network capacity simulations have been performed for 12 different operation modes of the test system in all three cases. Firstly, the wind farms have been connected to the test system in four different ways in the simulations: both farms connected to the 110 kV busbars of the 400/110 kV substations (Buses 11 and 12), both farms connected to the 110 kV substations further in 110 kV network (Buses 15 and 16), the farm at Bus 14 connected to Bus 11 and the farm at Bus 13 connected to Bus 16, and the farm at Bus 14 connected to Bus 15 and the farm at Bus 13 connected to Bus 12. In addition, the simulations have been performed for each of the four wind farm connection modes with three different operation modes of the 110 kV network. The first operation mode is pure radial use, which means that Line 12-18 as well as Line 15-16 is open. In the second mode, Line 12-18 is open and Line 15-16 is closed, which means that a loop is being formed in the test system via 110 kV and 400 kV network. The third operation mode is completely meshed operation, which means that both Line 12-18 and Line 15-16 are closed.

## Boundary conditions

The boundary conditions of the network capacity simulations have been selected as realistically as possible to match the situations of actual network. The maximum thermal capacity of the lines is difficult to determine, since it depends on the several things, as has been said in Chapter 3.2.1. For transmission lines, the most important factor is the maximum allowed dip of the line which depends on the maximum temperature that can be allowed for the line. The maximum thermal capacities of 400 kV lines usually have no influence on the adequacy of the network and they are not exceeded in the simulations. However, the thermal capacities of 110 kV 2-Duck lines have an impact on the simulations. In Fingrid's networks, the maximum allowed temperature for new 2-Duck lines is 80 °C, which means that the maximum capacity of the lines is about 345 MVA, when the outdoor temperature is 20 °C. Still, the maximum capacity of 110 kV breakers is 1.2 kA, which is about 245 MVA, if the voltage in the network is 118 kV. Moreover, the maximum capacity of the traditional 2-Duck lines is 1.28 kA. The difference between the new and the traditional lines is due to the fact that Fingrid uses higher value for the maximum allowed temperature in the case of the new line. This has been accomplished by changing the pole structures so that a greater dip can be allowed for the line. However, since the simulations model the HVDNs which are not part of Fingrid's network, the maximum thermal capacity of 110 kV 2-Duck lines in the test system is traditional 1.28 kA, which means that a maximum power of about 260 MVA can be transferred through the line, if the voltage in the line is 118 kV. (Pihkala 2009; Reilander 2012a; Reilander 2012b)

In addition to the maximum thermal capacities of the lines, it has been decided that the voltages in 400 kV and 110 kV networks of the test system must remain within the normal limits defined by Fingrid, which are 395-420 kV and 105-123 kV, respectively (Fingrid 2007a). The voltages in 20 kV network must be within the range of  $U_n \pm 10\%$ , which means that the voltages must be within the borders of 18-22 kV. In addition, the voltages in Buses 11 and 12, which are the 110 kV busbars of the 400/110 kV substations, must remain within the borders of 115-119 kV (Kuusela 2012). This is because the voltage in the 110 kV busbar of 400/110 kV substation affect on the voltages of all 110 kV feeders of the 400/110 kV substations. In traditional 110 kV feeder, the direction of the power flow is from the 110 kV busbar of 400/110 kV substation to the rest of 110 kV network and, therefore, the voltage is lower in the far end of the network than in the 110 kV busbar due to the voltage drop. Consequently, by keeping the voltage in the 110 kV busbar high, also the magnitudes of the voltages are greater in the network onwards from that.

## Analysis of results

The results of the network capacity simulations, which have been presented in Appendix 3, show that the maximum wind power capacity, which can be connected to

the network, depends on the structure, operation mode and load of the network. Generally, it can be noted that the shorter the lengths of the network lines are, the greater is the amount of connectable wind power due to the smaller voltage drops in the lines. However, the effects of the operation mode and load of the network on the amount of connectable wind power are not as unequivocal as the effects of the line lengths. In all cases, more wind power can be connected to the network, when the loads of the network are maximum than when they are minimum. Still, the size of the difference in the connectable wind power between the maximum and minimum load situations varies case by case, since it depends significantly on the operation mode of the network. The difference is the greatest, when both wind farms are connected to the 110 kV busbars further in the network (Buses 15 and 16); and the smallest, when both farms are connected to the 110 kV busbars of the 400/110 kV substations (Buses 11 and 12). When both farms are connected to Buses 15 and 16, the wind power capacity of the network in the minimum load situation is 86 % of the wind power capacity in the maximum load situation. On the contrary, when wind farms are connected to Buses 11 and 12, the wind power capacity in the minimum load situation is 97.8 % of the wind power capacity in the maximum load situation. With other two remaining connection modes of the wind farms, the difference between the maximum and minimum load situations settles between the previous two.

The difference between the situations depends on the dimensioning factor of the situation and on how much the loads of the network reduce the wind power which is being transferred through the network. For example in Case 1, in which all the lines of the network are the longest of the situations, the dimensioning factors are usually the voltages in Buses 11 and 12 and the maximum connectable wind power capacities are so small in the minimum load situations that the load capacities of the lines are completely sufficient in most of the situations. In this case, the amount of connectable wind power to the network is significantly larger in the maximum load situations, since the connection lines of wind farms withstand the power increase and the loads of the network consume part of the wind power so that the voltages in Buses 11 and 12 do not decrease due to the voltage drop as much as in the case of the minimum load situation.

In addition, the results of the network capacity simulations can be used to compare the operation modes of the network. In Case 1, when the lines are the longest, the total connectable wind power capacity of the maximum and minimum load situations is the lowest, when both farms are connected to Buses 11 and 12. In addition, as has been said above, the difference between the maximum and minimum load situations in connectable wind power capacity is the smallest in the same connection mode. Hence, the connection situation appears to be the worst in the case of long network lines. However, the connection mode also has strengths over the other modes since with the connection mode the amount of connectable wind power to the network in the minimum load situation is higher than in other modes. Moreover, the small difference in the connectable wind power between the load situations can be strength, since it might

facilitate the operation of the network, because the wind power connection capacity is more stable during load changes.

Next, the thesis compares the operation modes in Case 2, where the wind farms' connection lines from Buses 14 and 13 to Buses 11 and 12 are significantly shorter than the total lengths of the lines, when connecting the wind farms to Buses 11 and 12 via Buses 16 and 15. In this case, the connection mode, in which the wind farms are connected directly to Buses 11 and 12, provides significantly greater connectable wind power capacity than the connection mode, where the farms are connected to Buses 15 and 16. This is due to the noticeably smaller voltage drop with the first mode because of the shorter line lengths. The two other analysed operation modes, where other of the wind farms have been connected to 110 kV busbar further in the network and other to the 110 kV busbar of 400/110 kV substation, enable wind power connection capacity which is between the capacities of the first two operation modes.

In Case 3, where the line lengths are in the same proportion that in Case 1 but shorter, the wind power connection capacities are practically identical in all operation modes. This is because the dimensioning factor with all operation modes and in all load situations is practically without exception the load capacity of the connection lines of the wind farms. This means that the voltage drops in the lines of the network are so small in all situations that the thermal load capacities of the lines reach their limit before the voltages of the network. However, even though the total connectable wind power capacity of the minimum and maximum load situations is almost identical regardless of the connection mode of the wind farms, the difference between the two load situations varies in the same way, as in Case 1, depending on the connection mode of the farms and operation mode of the network.

All in all, the most suitable connection mode of the wind farms is not simple to determine, since it depends on the structure and type of the particular network. In addition, it is not easy to determine the optimal operation mode for the network with wind power, because in some situations depending on the connection mode of the farms the meshed operation appears to increase the wind power connection capacity and in some situations it does not.

#### **4.6.2. Load and wind power variability**

Since the results of the network capacity simulations show that the maximum amount of wind power, which can be connected to the network, depends on the load situation of the network, the simulations of the thesis will next analyse the differences in the wind power production fluctuations and load fluctuations. This has been accomplished by comparing the total hourly real power load of the test system and total hourly wind power production of two 250 MW wind farms. The comparison has been made for two weeks in January, when the load is at its maximum, and for two weeks in July, when the load is at its minimum. The curves of the total load and total wind power production of the test system in January are presented in Figure 4.3 and in July in Figure 4.4.

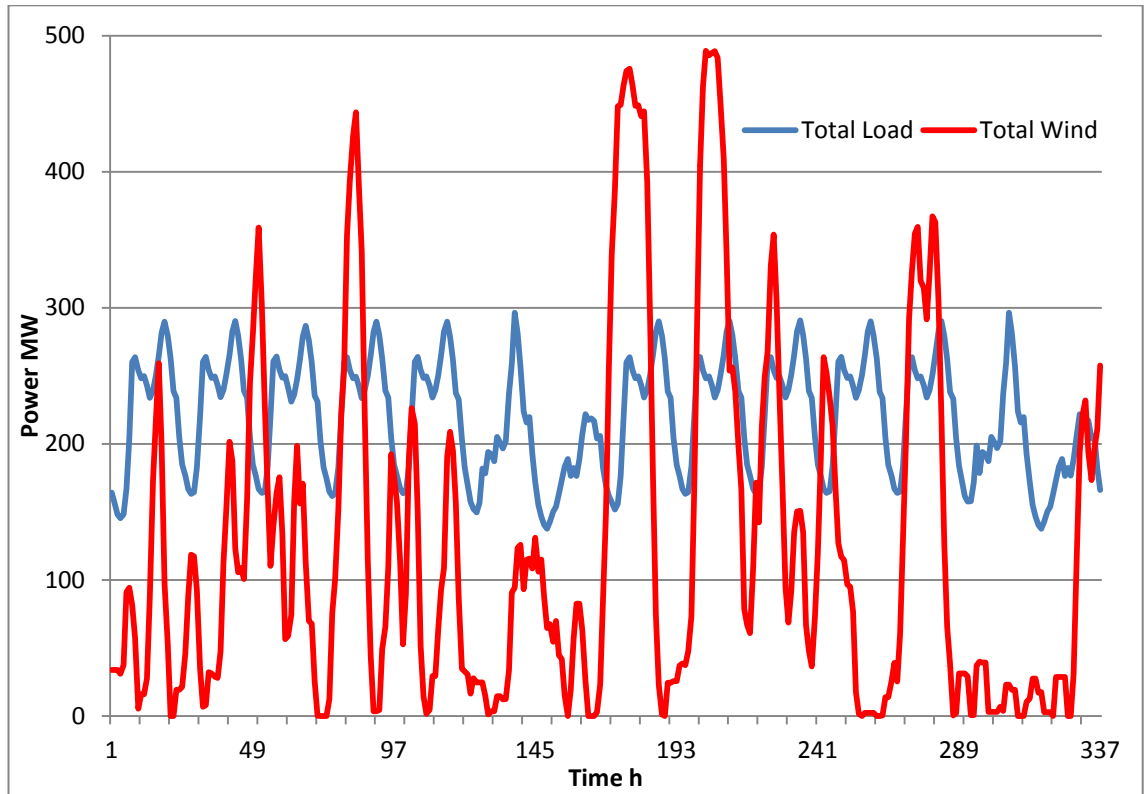

**Figure 4.3.** The variability of the total load and wind power production of the test system in the winter.

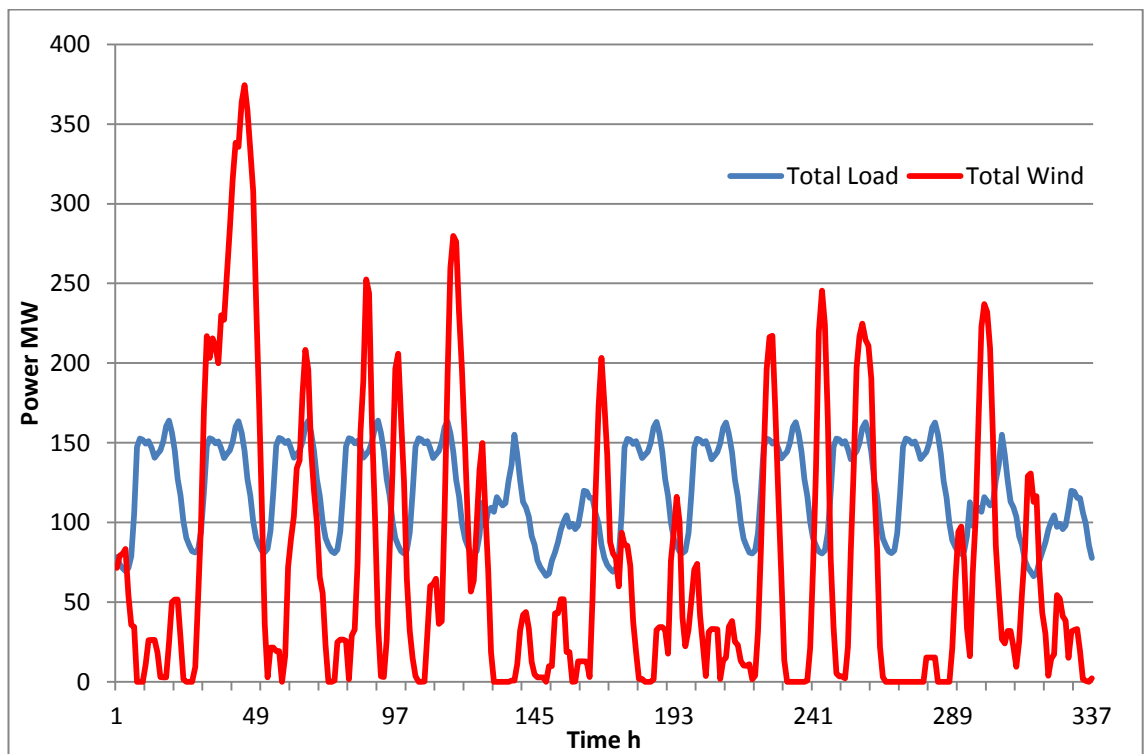

**Figure 4.4.** The variability of the total load and wind power production of the test system in the summer.

As can be seen from Figure 4.3 and 4.4, the fluctuations in the total wind power production of the test system are quite random compared with the fluctuations in the total load of the system which comply with regular weekly and daily patterns. In addition, it can be seen that a clear distinction between the fluctuations in winter and in summer cannot be detected. However, it seems that the total amount of wind power production is slightly higher during these particular two winter weeks than during two summer weeks. Hence, it can be noted that during the winter and cold weather conditions wind speeds are sufficient or maybe even better for wind power production than during the warm summer conditions.

### **4.6.3. Voltage variations**

#### **Voltage simulations with no wind power**

Next, the simulations will analyse the affects of the wind power production fluctuations on the voltages of the test system. The simulations have been performed with Case 1 network test system with the pure radial operation mode, which means that Lines 12-18 and 15-16 are open. This case has been selected for the simulations, because it has the longest line lengths of the cases and, therefore, it is presumably the worst case regarding to the network voltages. The simulations have been carried out with Time Step Simulation tool of Power World simulator. Time Step Simulation tool is used to calculate the power flow of the test system separately for each hour of the desired time period, which enables the analysis of the voltages, losses and other variables of the network, while the load and wind power production experience hourly variations. The simulations have been performed for one week period in January and in July. Firstly, the simulations have been carried out for Case 1 network, where all the lines that are connected to the wind farms have been disconnected so that there is no wind power production in the network. The voltages of the network and the total load of the test system have been presented as a function of time in winter in Figure 4.5 and in summer in Figure 4.6.

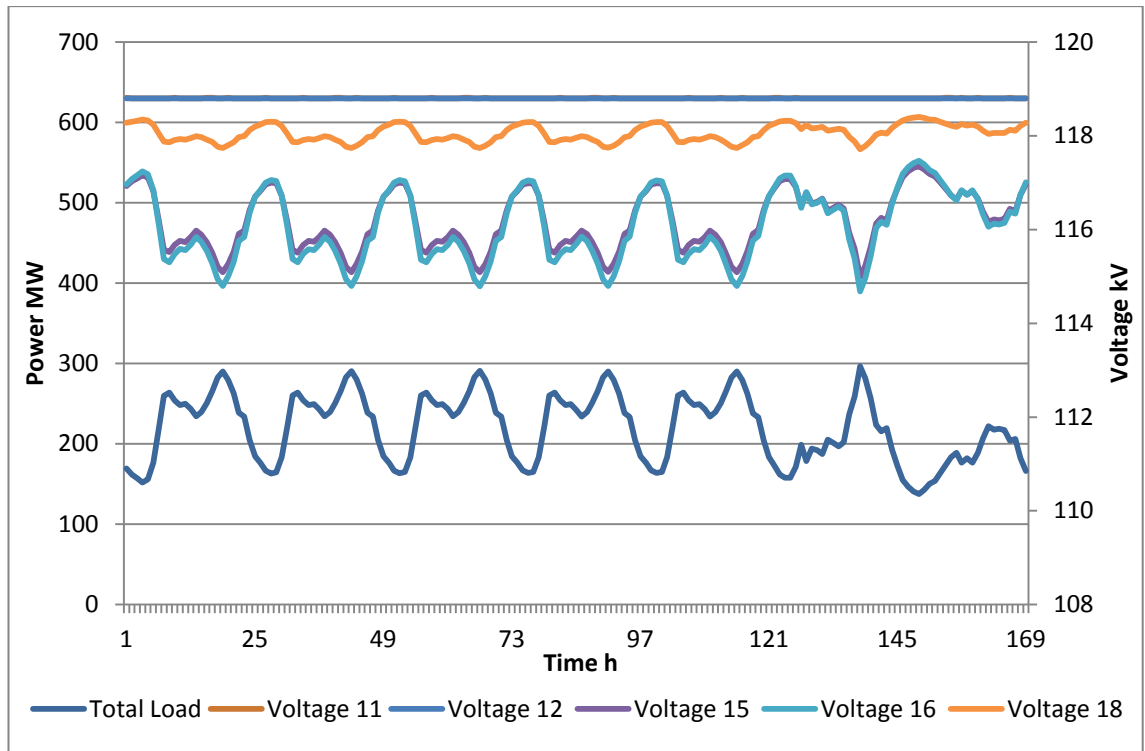

**Figure 4.5.** The voltages and total load of the network in winter without wind farms.

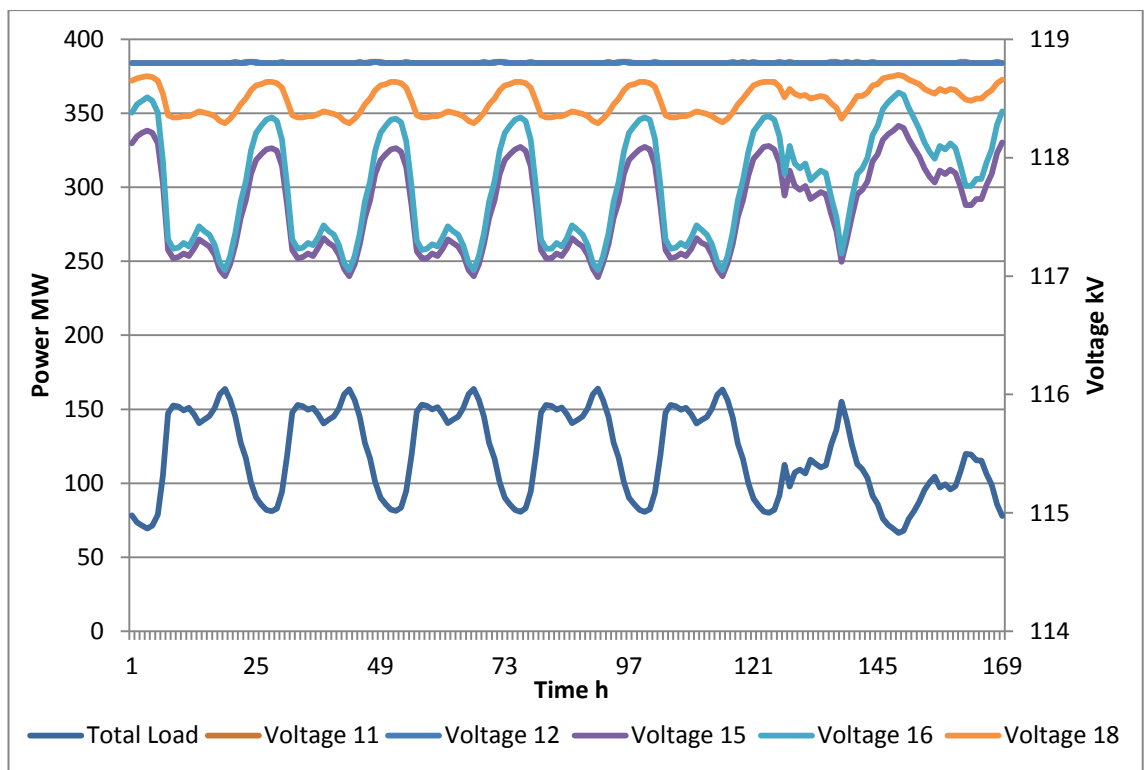

**Figure 4.6.** The voltages and total load of the network in summer without wind farms.

As can be seen from Figures 4.5 and 4.6, the voltages of the network depend on the load of the test system, when there is no wind power in the network. Voltages 11 and 12 are constantly 118.8 kV and the other voltages of the network vary depending on the



voltage drop, which depends on the power transferred through the network and on the impedances of the network. Hence, Voltages 15, 16 and 18 are the higher, the lower the load of the system is and vice versa.

### Voltage simulation with winter week data

Next, the simulations have been performed for Case 1 network which has two 250 MW wind farms. The nominal power of the wind farms has been set to 250 MW, because the network capacity simulations demonstrated that 500 MW from two wind farms is generally close to the maximum amount of wind power that can be tolerated by the system. The simulations have been performed for one week period in January and in July, as the previous voltage simulations without wind farms. However, the result curves of the simulations do not contain Voltages 14 and 15 for reasons of clarity, since, in radial network operation, Voltage 14 and Voltage 15 behave similarly with Voltage 13 and Voltage 16, respectively. In addition, the simulations have been performed for two connecting modes of wind farms: both farms connected to the 110 kV busbars of the 400/110 kV substations (Buses 11 and 12) or both farms connected to the 110 kV busbars further in 110 kV network (Buses 15 and 16). The latter of the connection modes was analysed first. The wind power production of Wind Farms 14 and 13 that are connected to Buses 15 and 16 as well as the voltages and total load of the network for one week period during winter have been presented in Figure 4.7.

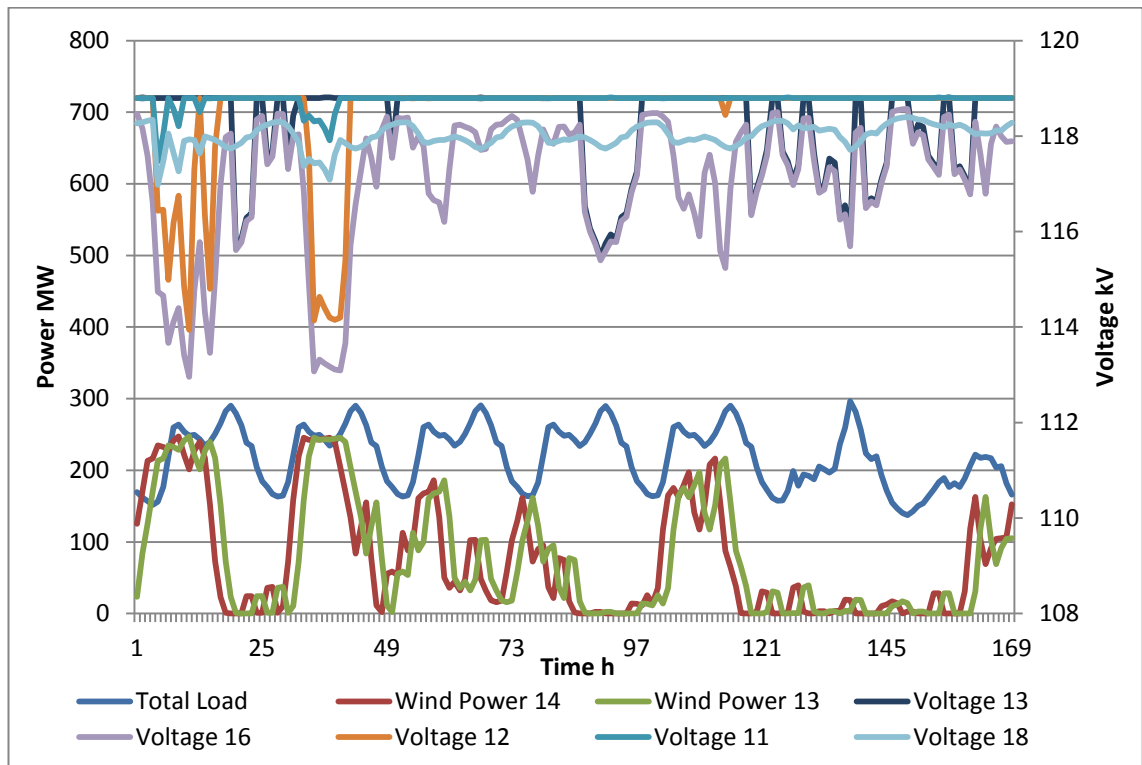
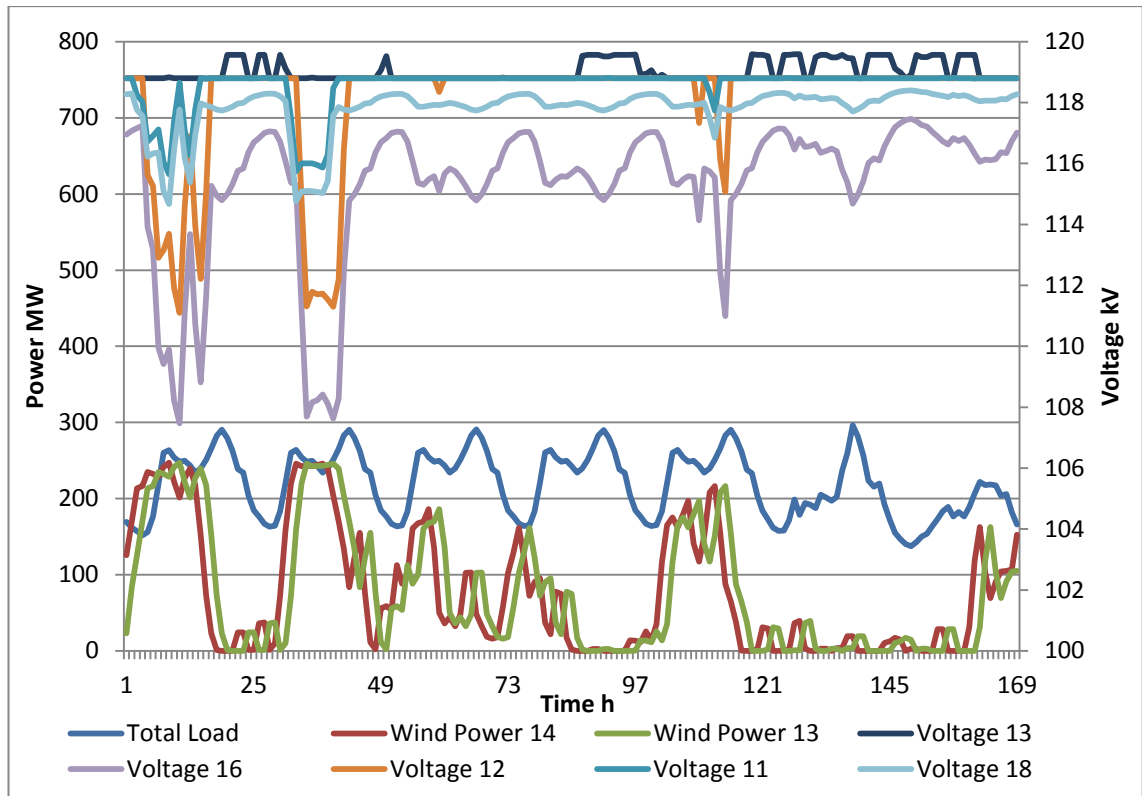

**Figure 4.7.** The voltages, total load and wind power production of the network in winter with two 250 MW wind farms connected to Buses 15 and 16.

As can be seen from Figure 4.7, in contrast to the case of no wind power in the network, in this case the total load and voltages of the network have no direct similarities with an exception of Voltage 18, since Bus 18 is in the different 110 kV feeder than the wind farms. Instead, the voltages of the network depend mostly on the production of the wind farms. When the power production of the wind farms is zero, the wind farms do not participate in the voltage control of the network due to the insufficient reactive power capacity. In this case, the voltages of the network depend only on the load of the network, as in the previous simulation case without wind power.

On the contrary, when the wind farms are producing real power, they participate in the voltage control with their reactive power capacity. This means that the voltages in the connection points of the wind farms (Buses 13 and 14) are constantly 118.8 kV and the real power is being transferred from the buses to Buses 16 and 15, which means that Voltages 15 and 16 are lower than the wind farm voltages due to the voltage drop. Moreover, when the wind power production in Bus 13 exceeds the amount of real power load in Bus 16, the real power flow in Line 12-16 turns towards Bus 12. However, since the loads and high loaded 110 kV lines consume reactive power, the reactive power flow and the reactive component of the voltage drop will remain towards Bus 16 in Line 12-16. The reactive component of the voltage drop in Line 12-16 is greater than the real component, which means that Voltage 12 is higher than Voltage 16. In addition, when the wind power production continues to increase, the power lines will consume even more reactive power. This means that the reactive power flows from Buses 13 and 12 to Bus 16 must be increased. At some point, the reactive power capacity of the generator in Bus 12 will no longer be sufficient to increase its production, in which case Voltage 12 starts to fall. This can be seen in Figure 4.7, for example, at the time of 35 hours. The same phenomena also occur in similar situations in the 110 kV feeder of the other 400/110 kV substations, to which the other wind farm has been connected.

Next, the simulations will analyse the voltages of the network with the same winter week data as above. However, now the wind farms have been connected straight to the 110 kV busbars of the 400/110 kV substations (Buses 11 and 12). The wind power productions of Wind Farms 14 and 13 as well as the voltages and total load of the network for one week period in winter have been presented in Figure 4.8.



**Figure 4.8.** The voltages, total load and wind power production of the network in winter with two 250 MW wind farms connected to Buses 11 and 12.

It can be seen from Figure 4.8 that there is a clear correlation between the total load of the network and Voltages 16 and 18, as in the case of no wind power in the network. The voltage of the wind farm (Voltage 13) is constantly 118.8 kV except, when the production of the wind farm is zero, in which case Voltage 13 is over 118.8 kV due to the Ferranti effect in unloaded Line 12-13. When the wind power production in Bus 13 increases, so does the real power flow in Line 12-13. This means that the real component of the voltage drop in Line 12-13 is from Bus 13 to Bus 12. The voltage control of the network aims to keep the voltage in Bus 12 as well as in Bus 13 at 118.8 kV. Therefore, the reactive component of the voltage drop must be equal but opposite with the real component, so that the real and reactive components cancel each other. This means that the generator in Bus 12 must generate a large reactive power flow for Line 12-13. However, the reactive power capacity of the generator is limited, and when the reactive power capacity of the generator is being exceeded, Voltage 12 starts to drop, as happened in the previous case. This can also be seen in Figure 4.8 at the time of 35 hours.

By comparing the two connection modes of the wind farms in the winter load and wind conditions, it can be seen that the voltage in the 110 kV busbar of the 400/110 kV substation (Bus 12) falls below the limit of 115 kV with both wind farms connection modes when the production of both wind farms is close to the nominal power production. However, the voltages of the network are higher and especially Voltage 12 is higher when the wind farms have been connected to Buses 15 and 16. This is because

the voltage drop from wind farm Bus 13 to Bus 12 is lower in this situation, since the loads of the network reduce the power transferred in the network.

### Voltage simulation with summer week data

After these simulations, the similar simulations have been performed with the load and wind power production data of one summer week. As previously, the simulations have been made first for the case where the wind farms have been connected to Buses 15 and 16. The results of the voltage simulations with the summer week data have been presented in Figure 4.9.

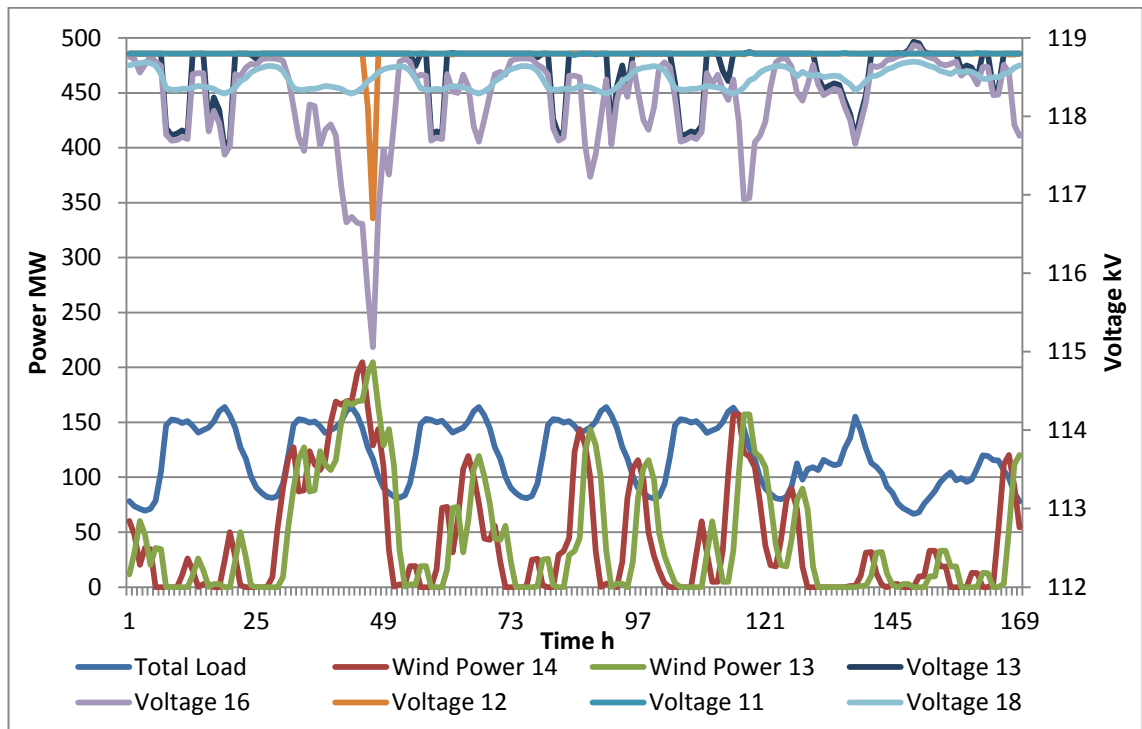
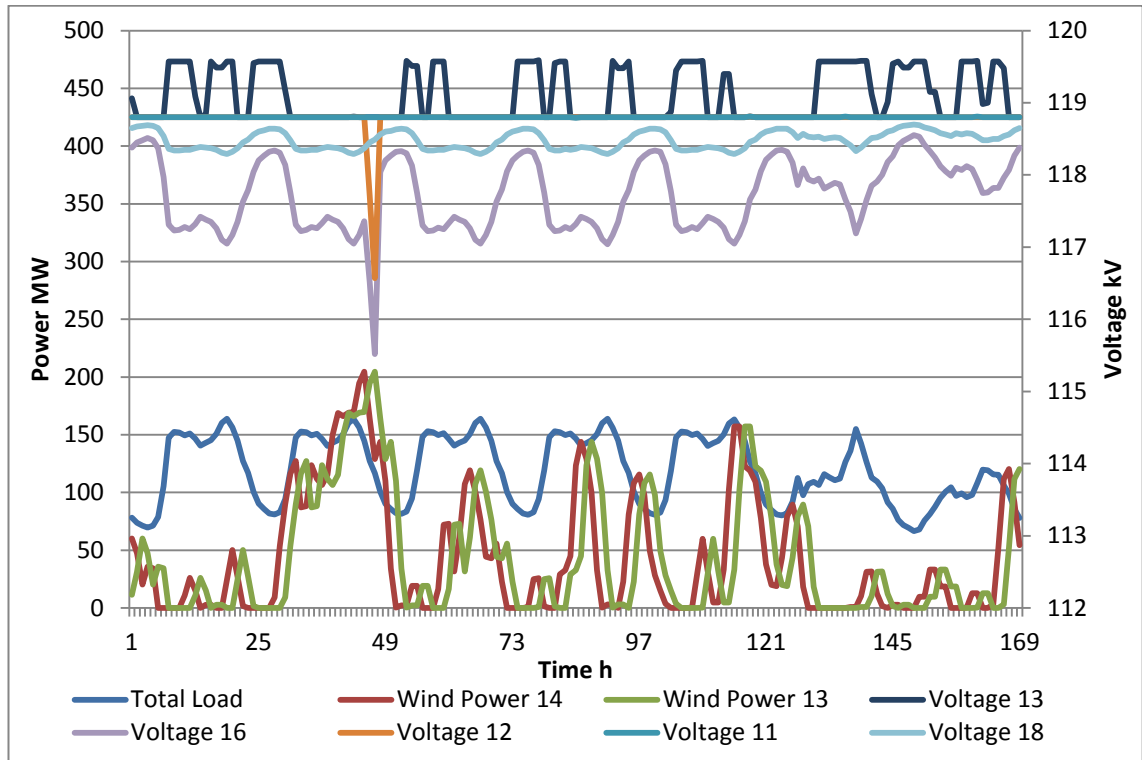

**Figure 4.9.** The voltages, total load and wind power production of the network in summer with two 250 MW wind farms connected to Buses 15 and 16.

It can be seen from Figure 4.9 that, as in the case of the winter data, there is no correlation between the voltages and load of the network in this case with an exception of Voltage 18. Moreover, the voltages of the network fall, when the wind power production exceeds a certain level, due to the same reason as in the winter case. However, it can be seen by comparing the voltages in Figure 4.7 and Figure 4.9 at the point, where the wind power production of Bus 13 is about 210 MW that the voltages of the network fall more easily due to the increasing wind power production in this case than in the case of winter load. This is simply because the loads of the network are smaller, which means that a greater power is transferred through the network from Bus 13 to Bus 12, which means that a greater amount of reactive power must be produced by generators to meet the reactive power consumed by the power lines and the reactive

power needed to keep the voltage drop in Line 12-16 correctly orientated. Hence, the reactive power capacities of the 110 kV generators of the 400/110 kV substations are being exceeded with a smaller amount of wind power production in the summer load situation than in case of winter load.

Next, the similar simulations with the summer week data have been carried out for the other connection mode of the wind farms. The results of the simulation, where the wind farms have been connected to Buses 11 and 12, have been presented in Figure 4.10.



**Figure 4.10.** The voltages, total load and wind power production of the network in summer with two 250 MW wind farms connected to Buses 11 and 12.

It can be seen from Figure 4.10 that there is a clear correlation between the total load of the network and Voltages 16 and 18, as in the case of winter load with the same wind farms' connection mode. In addition, Voltage 13 behaves similarly as in the case of the winter data. When comparing the voltages in Figure 4.8 and Figure 4.10, it can be seen that in the case of summer load, the voltage in the 110 kV busbar of the 400/110 kV substation (Bus 12) does not fall as much, as in the case of winter load with the same amount of wind power production. This is because the reactive power consumption of the lines and loads is lower due to the smaller total load of the network, which means that the available reactive power capacity of Generator 12 for the voltage control is greater. Also, the other voltages of the network do not fall as easily in the case of summer data, since the voltage drop from Bus 12 to other 110 kV buses is smaller due to the smaller amount of transferred power.

## **Analysis of results**

By comparing the two connection modes of the wind farms in the summer load and wind conditions, it can be seen that the voltages in the network are approximately at the same level with both connection modes of the wind farms. This is because the voltage drop from wind farm Bus 13 to Bus 12 is about the same in both situations, because the loads do not reduce the transferred power significantly.

By comparing the results of these voltage simulations with the results of the network capacity simulations in Case 1 network, it can be seen that the results are in line with each other. The voltages in the network are higher in the simulations with the high winter loads, when the wind farms have been connected to Buses 15 and 16 than, when they have been connected to Buses 11 and 12. Also, the results of the network capacity simulations show that the connectable wind power capacity is greater during the maximum load situation when the wind farms have been connected to Buses 15 and 16.

On the other hand, as has been said before, the voltages in the network are approximately at the same level with both wind farm connection modes during the low summer loads. However, the network capacity simulations showed that the connectable wind power capacity is higher in the minimum load situation, when the wind farms have been connected to Buses 11 and 12, which means that also the voltages should be higher in the voltage simulations with the same connection mode. Nonetheless, the voltages in the network are nearly equal in the voltage simulations with summer data with both wind farm connection modes, because the maximum wind production of the simulations is about 200 MW from both farms, which is insufficient for exceeding the connectable wind power capacity of the network in either of the connection mode cases.

## **Voltage simulations with whole year data**

Next, similar voltage simulations have been performed with the hourly data of the whole year with the same two wind farm connection modes. The results of the simulations have been presented in Figure 4.11, when the wind farms have been connected to Buses 15 and 16, and in Figure 4.12, when the wind farms have been connected to Buses 11 and 12.

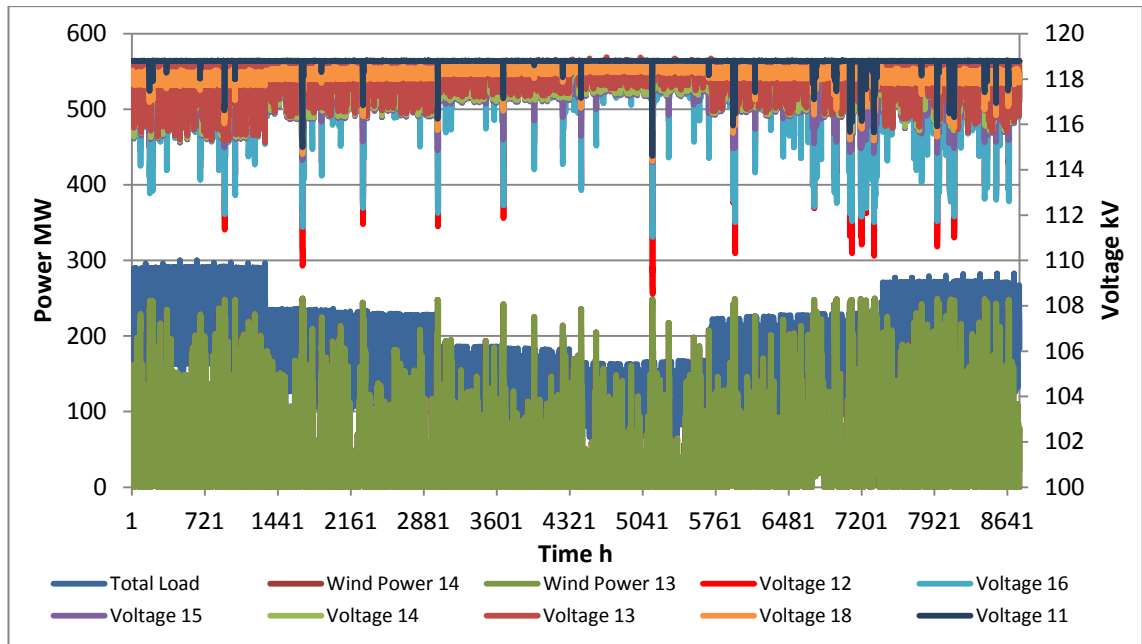

**Figure 4.11.** The voltages, total load and wind power production of the network with two 250 MW wind farms connected to Buses 15 and 16.

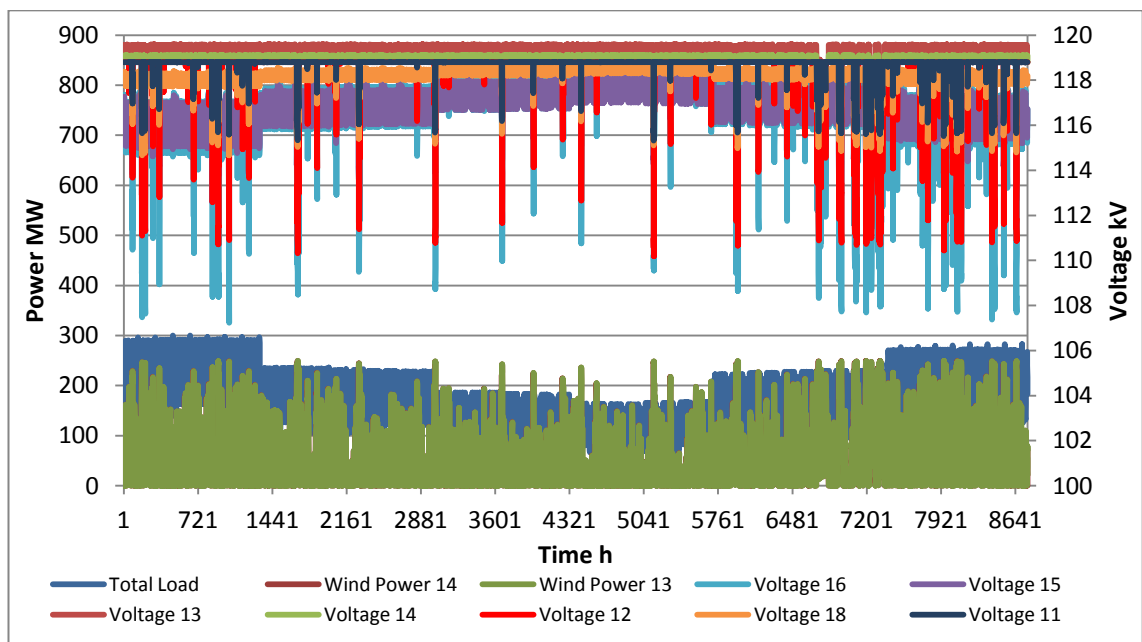

**Figure 4.12.** The voltages, total load and wind power production of the network with two 250 MW wind farms connected to Buses 11 and 12.

It can be seen from Figure 4.11 and 4.12 that the voltages in the network behave in the similar way with both wind farm connection modes and with the whole year data, as they did in the previous voltage simulations. In addition, the results of the simulations with the whole year data seem to correspond even more to the results of the network capacity simulations. The results show that the voltages in the network do not fall as often when the loads are high, if the wind farms have been connected to Buses 15 and 16 than, if the wind farms have been connected to Buses 11 and 12. This is because the

connectable wind power capacity of the network is higher in the maximum load situation with the first connection mode, as the network capacity simulations have shown. On the contrary, during the summer, when the loads are low, the voltages in the network fluctuate as often with both connection modes. However, when the wind farms have been connected to Buses 15 and 16, Voltage 12 falls lower than with the other connection mode. This is because the network can withstand more wind power production in the minimum load situation, when the wind farms have been connected to Buses 11 and 12, as the network capacity simulations have shown.

In addition, Figures 4.11 and 4.12 show that the wind power capacity of the network is not sufficient during all hours of the year, which is shown in the fact that the dimensioning voltages, Voltage 11 and 12, fall below the limit of 115 kV during some rare hours of the year. When the wind farms have been connected to Buses 15 and 16, Voltage 11 falls below the limit for only one hour in the year and Voltage 12 falls below the limit for 154 hours in the year, which is about 1.76 % of all the hours of the year. Correspondingly, when the wind farms have been connected to Buses 11 and 12, Voltage 11 does not fall below the limit at all and Voltage 12 falls below the limit for 224 hours in the year, which is about 2.56 % of all the hours of the year. Consequently, during these hours the wind power production in the test system must be curtailed in order to keep the voltages within the allowed limits. These situations could possibly be dealt by increasing the load of the network by using DSM, which would increase the connectable wind power capacity of the network. The effects of DSM have been studied later in the thesis.

#### 4.6.4. Losses

Lastly, the simulation of the thesis will analyse the power losses of the network with the same two wind power connection modes and without wind power. These simulations have been performed with the data of the whole year. The losses of the network have been calculated for each hour of the year, and then the total losses of the year have been obtained by summing up the hourly losses. Results of the calculations have been presented in Table 4.3.

*Table 4.3. The losses of the test system during one year.*

	No wind power	WFs connected to Buses 15 and 16	WFs connected to Buses 11 and 12
<b>400 kV Real Power Losses MWh</b>	1586	1020	1020
<b>400 kV Reactive Power Losses MVarh</b>	-1162864	-1172490	-1172495
<b>110 kV Real Power Losses MWh</b>	6724	34601	44755
<b>110kV Reactive Power Losses MVarh</b>	139130	234165	239347



As can be seen from Table 4.3, the real power losses of 400 kV network are being decreased, when wind power is being connected to the network. This is because the power transmission is being reduced in 400 kV network, because the wind farms produce part of the power that is being consumed in the network. For the same reason, the reactive power losses of 400 kV network are being slightly decreased when wind power is being connected to the network. The reactive power losses of 400 kV network are negative because the real power transmission through the lines of 400 kV network is so low that the lines are producing reactive power instead of consuming it. The real power losses of 110 kV network are being increased significantly when wind power is being connected to the network. Moreover, the real power losses increase even more when the wind farms are being connected to Buses 11 and 12. This is due to the fact that the wind farms increase the power transmission in 110 kV network significantly, which means that also the real power losses increase in the network. In this case, also the reactive power losses increase, since the lines of 110 kV network consume more reactive power. All in all, the losses of the network depend on the amount of power transferred through the network and the impedances of the network components. This means that the losses are the bigger, the greater is the transferred power. This is why the losses of 110 kV network are the largest, when the wind farms have been connected to Buses 11 and 12, since in this case the loads of the network do not reduce the power that is transferred through 110 kV network.

#### **4.6.5. Demand side management**

Lastly, the simulations will examine the possibilities and benefits of DSM for the planning and operation of the HVDNs. The simulations have been carried out with three different types of DSM. The operation mode of 110 kV network is the pure radial mode in all the simulations, so that the results can be compared with the previous voltage simulations. Firstly, the two 250 MW wind farms have been connected to the 110 kV substations further in the network (Buses 15 and 16), and the loads in Buses 15 and 16 have been controlled so that, when the voltage in Bus 11 or 12 drops under 115 kV, the real and reactive power loads in Bus 15 or 16 are increased to the maximum, respectively. This decreases the power transfer in Line 11-15 or 12-16, which increases the voltage in Bus 11 or 12, respectively. The results of these simulations with the whole year data have been presented in Figure 4.13.

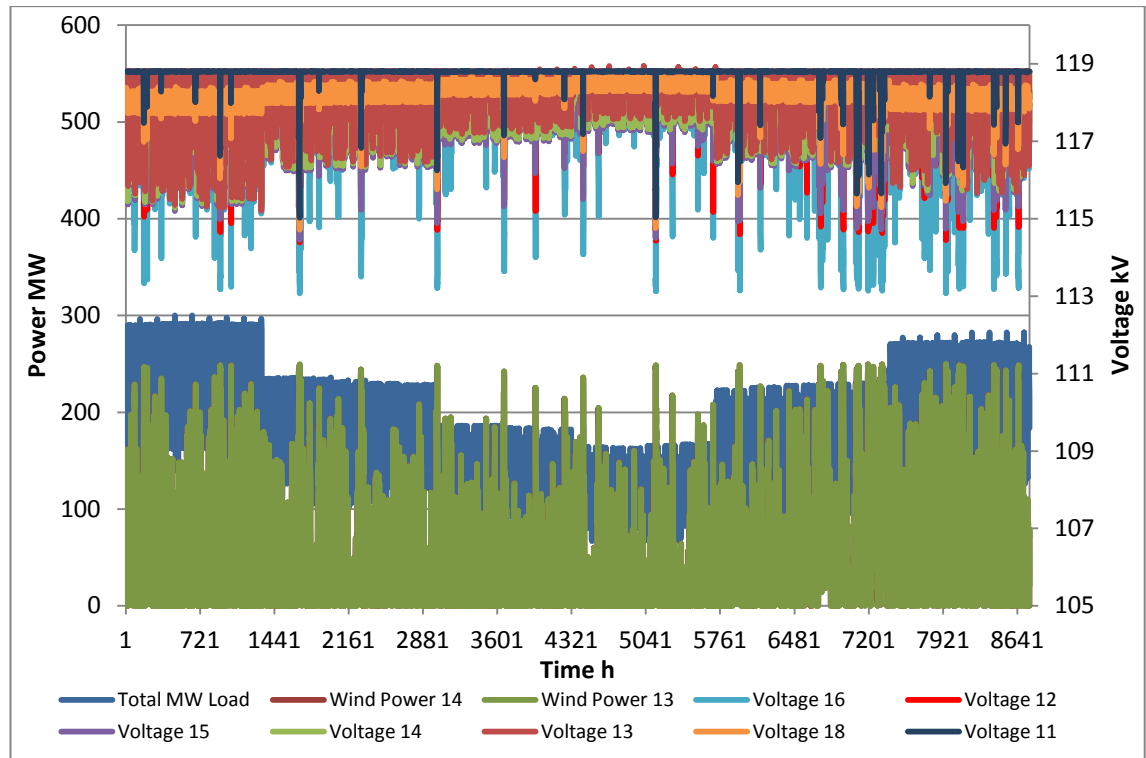

**Figure 4.13.** The voltages, total load and wind power production of the network with two 250 MW wind farms connected to Buses 15 and 16, and with controllable loads in Buses 15 and 16.

It can be seen by comparing the results in Figure 4.13 and Figure 4.11 that the lowest values of Voltage 12 and 16 are significantly higher, when DSM is used in the network. In addition, without DSM, Voltage 11 falls below 115 kV for one hour in the year and Voltage 12 falls below 115 kV for 154 hours in the year. On the contrary, with DSM, Voltage 11 does not fall below 115 kV and Voltage 12 falls below 115 kV for 39 hours in the year, which is about 25 % of the value without DSM. Moreover, the lowest values of Voltage 12 are just slightly less than 115 kV, which means that by using DSM the voltages in the network will remain better within the allowed boundaries. All in all, DSM reduces the need for the curtailment of wind power, in which case the potential electrical energy which can be produced by wind is being used more efficiently.

Next, the simulation will analyse the situation, where the wind farms have been connected to Buses 11 and 12 and the loads in Buses 11 and 12 are controllable. The loads have been controlled so that, when the voltage in Bus 11 or 12 drops under 115 kV, the real and reactive power loads in Bus 11 or Bus 12 are increased to the maximum, respectively. However, as the previous simulations have shown, Voltage 11 does not drop below 115 kV with this wind farm connection mode, which means that only the DSM feature of Load 12 will be used in the simulations. The results of the simulations have been presented in Figure 4.14.

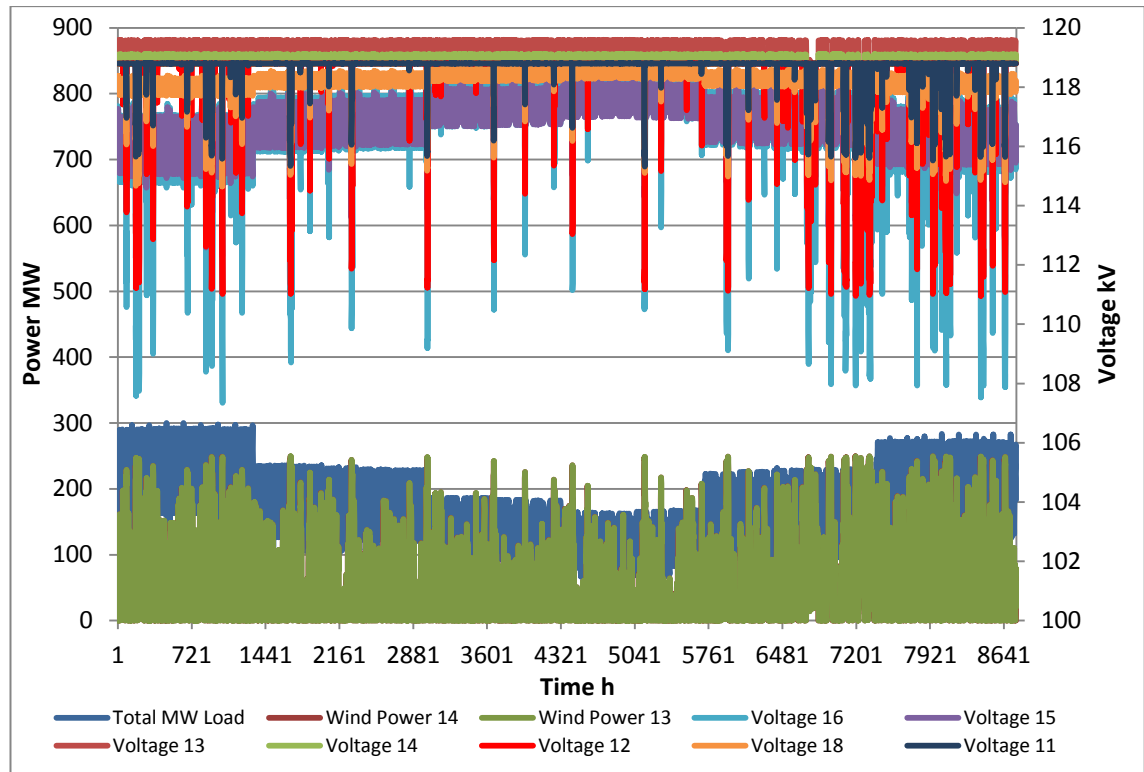

**Figure 4.14.** The voltages, total load and wind power production of the network with two 250 MW wind farms connected to Buses 11 and 12, and with controllable loads in Buses 11 and 12.

It can be seen by comparing the results in Figure 4.14 and Figure 4.12 that the lowest values of Voltage 12 and 16 are almost at the same level regardless of the use of DSM in the network. The voltages are about 1 kV higher with DSM at the highest and the lowest levels of Voltage 12 remain clearly below 115 kV. In addition, without DSM, Voltage 12 falls below 115 kV for 224 hours in the year. On the contrary, with DSM, Voltage 12 drops below 115 kV for 218 hours in the year, which is about 97 % of the value without DSM. This means that, when the wind farms have been connected to Buses 11 and 12, DSM can hardly be used to prevent the curtailment of the wind power.

Lastly, the benefits of DSM will be analysed with the situation, where the wind farms have been connected to Buses 15 and 16 and the loads in Buses 15, 16 and 12 are controllable. The load in Bus 15 has been controlled in such way that, when Voltage 11 drops below 115 kV, the real and reactive power loads in Bus 15 are increased to the maximum. The loads in Buses 12 and 16 have been controlled so that, when Voltage 12 drops below 115 kV, only the real power consumptions of the loads in Buses 12 and 16 are increased to the maximum and the reactive power loads remain unchanged. The results of the simulations have been presented in Figure 4.15.

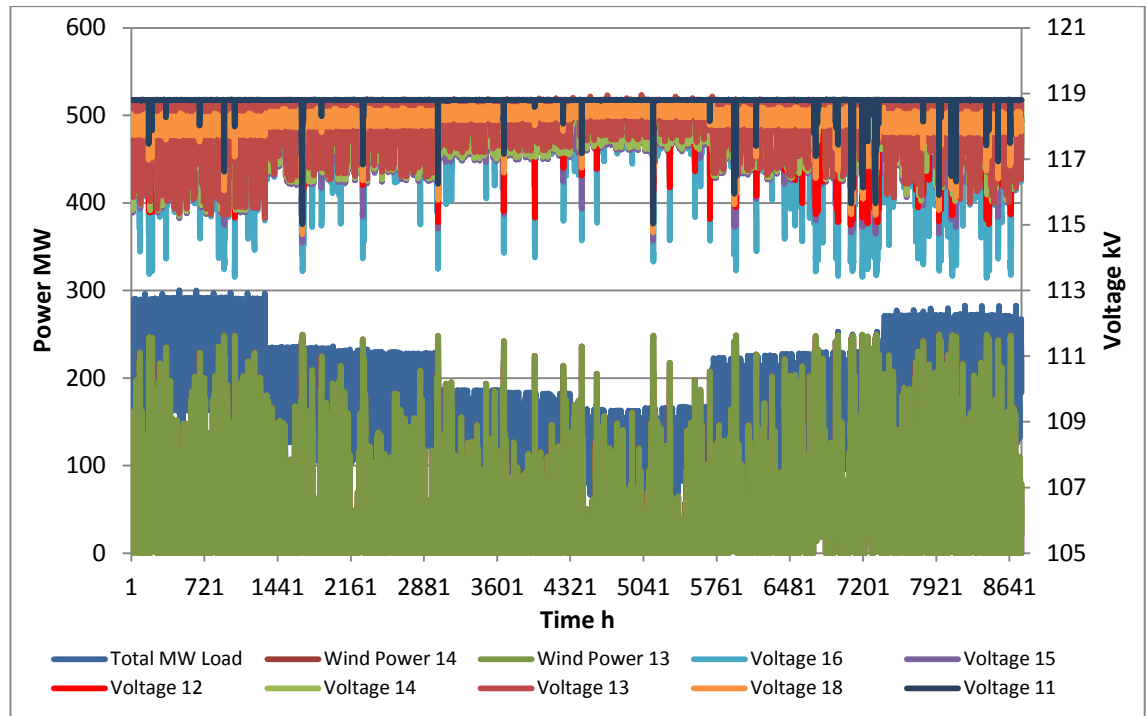

**Figure 4.15.** The voltages, total load and wind power production of the network with two 250 MW wind farms connected to Buses 15 and 16, and with controllable loads in Buses 12, 15 and 16.

As can be seen from Figure 4.15, Voltage 11 and Voltage 12 are within the limits at all times, which means that there is no need for the curtailment of the wind power production of the wind farms. Also, the other voltages in the network are at their highest of the simulations with this connection mode and DSM application. In conclusion, the DSM simulations have shown that, if the wind farms have been connected to Buses 15 and 16, DSM can be used to handle the temporary situations in the network, when the capacity of the network is not sufficient to withstand all the power which is being produced by wind plants. This means that DSM can be used effectively to reduce the need for the curtailment of wind power.

### Analysis of results

As the simulations of the thesis have shown, DSM can be used in the HVDNs effectively to reduce the need for the curtailment of the wind power during the situations, when the adequacy of the network is not sufficient. However, this means that wind plants must be connected so that there are also loads in the same 110 kV feeder. These results have been illustrated in Table 4.4, which shows the previously discussed number of hours, in which the boundary conditions of Voltage 12 are being exceeded, for the two connection modes of the wind farms with and without DSM.

**Table 4.4.** Voltage 12 in relation with its boundary conditions in 5 different situations.

Connection mode	Voltage 12 is under 115 kV, number of hours per year	% of 8760 hours	% of the previous value
<b>Wind Farms connected to Buses 11 and 12</b>			
No DSM	224	2,56	
DSM in Loads 11 and 12	218	2,49	97
<b>Wind Farms connected to Buses 15 and 16</b>			
No DSM	154	1,76	
DSM in Loads 15 and 16	39	0,45	25
DSM in Loads 12, 15 and 16	0	0,00	0

As can be seen from Table 4.4, DSM can be used effectively to increase the wind power production capacity of the network, when there are load points in the vicinity of wind plants. Table 4.4 illustrates that, when the wind farms have been connected to Buses 15 and 16, Voltage 12 remains substantially better within the limits when DSM is used in the network. However, it must be noted that the DSM method, which is used in the simulations, requires significant load growths, since the controllable loads in the network are assumed to be capable of increasing their consumption directly to the maximum at all times. The load change of this level may be challenging to implement in the case of actual network. All in all, it can be stated that, if DSM is intended to be used for increasing the wind power capacity of the network and to reduce the need for the curtailment of the wind power, wind plants must be connected in such way that there is load in the same feeder with the wind plants.

#### 4.6.6. Summary

All in all, it is not entirely easy to define the most suitable operation mode of the HVDN, when there is wind power connected to the network. Moreover, it is difficult to determine the most suitable network connection mode of the wind power plants. For these reasons, the planning of the wind power connection to the HVDNs is carried out case by case.

However, on the basis of the simulations, it can be said that, if a wind plant with the nominal power of 250 MW will be connected to the HVDN, the most suitable connection mode of the wind plant depends on the structure of the network and the distances between the wind plant and the substations of the network. Generally, if the distance is electrically shorter to 400 kV network, when the plant is being connected directly to 400/110 kV substation, than when the plant is being connected to 400/110 kV substation via an existing 110 kV substation and network lines, the most suitable connection mode is to connect the plant directly to the 400/110 kV substation. However, according to the simulations, if the electrical distances to 400 kV network are at least nearly equal with both of the connection modes, it should be considered that the wind

plant should be connected to the existing 110 kV substation, since the voltages in the network would be slightly higher on average in the case. In addition, in this situation the power losses in the HVDC would be significantly lower if the plant was connected to the existing 110 kV substation. Moreover, if DSM is intended to be used with wind power, the wind plants should be connected further in 110 kV network to existing 110 kV substations, since DSM benefits the planning and operation of the network only when there are loads in the vicinity of the wind plants. However, DSM can also be harmful in terms of the wind power capacity of the network, since DSM can reduce the wind power capacity. This is the case, if the loads of the network are controlled for the purpose of some other matter than the wind power capacity of the network, for example, in terms of the frequency control of the whole power network or by using electricity market price based DSM. In these cases, the loads of the network are being reduced when the electricity market price increases or the frequency of the network falls to a certain level. As the network capacity simulations have been demonstrated, this would reduce the connectable wind power capacity of the network when wind plants have been connected to the existing 110 kV substations further in the network.

#### **4.7. Noticing wind power in HVDC planning and operation**

It is not simple to determine how the increase in the amount of wind power production in the HVDCs will change the planning and operation of the HVDCs and how the wind power production should be noticed in the planning and operation. This is because there is only a small amount of wind power in the HVDCs at the moment and, hence, the practical experiences on the subject are rather limited in Finland. In addition, the existing wind power plants are technically different than the new wind plants that will be connected to the network, because the interconnection laws and regulations of wind power and power networks have become significantly stricter.

As has been said in Chapters 4.4 and 4.5, the most of the effects of wind power on the network planning and operation are caused by the high variability of the wind power production. In the HVDCs, the increase in the amount of variable wind power production in the network would lead to the fact that the variations in the network power flows would be increased significantly. This means that also the fluctuations in the network voltages would increase, as the voltage simulations of the thesis have shown. Consequently, the HVDC planning must take into account all the possible power flow situations in the network and ensure that the network is able to continue its normal operation in all situations. This means that the dimensioning situation of the network is not necessarily the situations of the maximum load in the case when there is wind power connected to the HVDC. Instead the planning must consider all the combinations of the wind production and network load, like for example, the situation of the maximum load and no wind power as well as the situation of the minimum load and maximum wind power.

Also, the operation of the HVDC becomes more difficult when wind plants are connected to the network. If the power flows of the network vary frequently, the monitoring and control of the network should be more active, which requires more resources or more automation into the network. Moreover, the finding and maintaining of the optimal power flow situation in the HVDC in terms of power losses and network adequacy is significantly more complicated when there are wind plants in the network.

In addition, one of the major challenges for the HVDC planning and operation, which is caused by the increase in wind power production, is related to the dimensioning of the network. As the results of the simulation have demonstrated, the dimensioning of the network is not entirely simple with variable wind power connected to the network. According to the network capacity simulations in Case 1 network with the pure radial operation mode, the maximum connectable wind power production capacity of the network is 430-500 MW depending on the connection mode of the wind power and the load situation of the network. However, the voltage simulations show that the capacity of the network is insufficient only during a small proportion of the hours of the year, when there is two 250 MW wind farms connected to the network, due to the variability of the wind power production and network loads. Hence, these overload situations could be handled, for example, by curtailing the wind power production or possibly by DSM, as the DSM simulations have shown, instead of reinforcing the network to withstand the maximum power of two wind farms constantly during all load situations.

In addition to these, wind power plants in the HVDC increase the power losses in 110 kV network significantly due to the increased power transfer in the network, as the simulations of this thesis have demonstrated. In addition, the simulations have shown that especially the real power losses of 110 kV network depend significantly on the connection mode of the wind plants. Therefore, also the losses of the network should be considered in the HVDC planning and operation and in the determination of the most suitable network structure and connection mode of the wind plants.

The wind plants in the HVDC can also be used to improve the voltages in the network locally, in which case the expensive reinforcements of the network can be potentially avoided or postponed. This means that wind plants must be connected further to the network instead of 400/110 kV substations.

As the simulations have shown, the selection of the connection mode of wind power is one of the key decisions in the HVDC planning, because all of the modes have their own strengths and weaknesses. Fingrid's attempt is at the moment that the wind plants in 110 kV network will be connected as close to 400/110 kV substation as possible. However, as the simulations have shown, by connecting the wind plants on 110 kV substations further in 110 kV network and closer to the loads, the power losses of 110 kV network are smaller and the connection mode is more preferable in terms of DSM than the connection mode which is currently favoured by Fingrid. Therefore, all the connection modes of wind power should be considered in the HVDC planning in the future by the HVDC operators and Fingrid.

As has been said in Chapter 4.2, the FRT capabilities that are required for wind power plants are very tight. This means that communication must be used to disconnect wind plants from the network, when a fault is being occurred in the vicinity of the plant, in which case the plant could compromise the safety of the network by feeding the fault current too long or by forming an unwanted island. Hence, the communication must be fast and reliable, so that the safety of the network is not jeopardized in any situation. Consequently, the wind plants in the HVDN increase the challenges in the planning of the HVDN protection settings and in the operation of the protection.

#### **4.8. Development needs**

As has been described in the thesis, the planning of the HVDNs is currently performed mainly by Fingrid in Finland, since only Fingrid has a calculation model which is covering the entire Finnish power network. In addition, Fingrid wants to verify all the plans, which are affecting the transmission network, with their own calculations. In the future, the planning needs of the HVDNs are likely to be increased due to the increase in the amount of wind power in the networks. (Reilander 2012b) This means that the planning resources of Fingrid may become insufficient. Therefore, it may be sensible to consider that whether it could be possible to move from a case by case method to some generally applicable methods in the planning of the HVDNs with wind power. Moreover, Fingrid influences the operation of the HVDNs, since all the connection and operation mode changes in the HVDN must be approved by Fingrid, which also consumes the resources of Fingrid. Therefore, it should be considered that whether it is wise that Fingrid is responsible for the HVDN planning as comprehensively in the future, since it probably means that Fingrid must increase its planning resources.

This leads to another issue, which is that whether Fingrid should increase their fees or begin to charge additional fees from the HVDN planning. Currently, the situation is that the planning services of Fingrid for the HVDN operators are included in the network transfer fees (Reilander 2012b). However, if Fingrid has to increase its planning resources, the increased costs must be covered somehow.

Another option would be that the HVDN operators would begin to plan and operate their networks more by themselves. This would mean that the operators would have to acquire appropriate software for the planning and operation of radial and meshed 110 kV networks. However, this change would probably be sensible only if Fingrid gave more freedom to the HVDN operators for the HVDN planning and operation. In addition, Fingrid should provide the operators with the calculation model of the transmission network. If Fingrid was not willing to give the calculation model of the whole Finnish network for the HVDN operators, Fingrid should provide the operators with the model which is accurate enough to be used in the HVDN planning. However, this would not be entirely simple, since the model's sufficient level of accuracy for the planning of the HVDNs with wind plants would be difficult to determine due to the limited practical experiences on the subject.



The uncertainty in the realization of the wind power projects causes problems in the HVDC planning, since the time horizon of the planning must probably be reduced. Therefore, the time spans of the Fingrid's regional network planning and the HVDC planning should be shortened, in which case the actual amount of wind power which will be connected to the network could be properly considered in the planning.

As the simulations of this thesis have illustrated, DSM can be effectively used to increase the wind power capacity of the HVDCs if necessary and to decrease the need for the curtailment of the wind power production. However, if DSM is used for the purpose of some other matter, like the frequency control of the network or electricity market price based DSM, DSM may reduce the controllable wind power capacity of the HVDC. In this case, it would be reasonable to control the 110 kV loads near the wind plants so that the wind power capacity of the HVDC is optimized and to use the other 110 kV loads and the loads at the other voltage levels of the network for the purposes of the other matters.

One of the most important issues in connecting wind plants to the HVDCs is the selection of the connection mode of the wind plants. As the simulations have shown, it affects significantly on the operation, wind power capacity and losses of the network. In addition, the exploitation potential of DSM depends significantly on the connection mode of the wind plants. Fingrid is currently aiming with its connection fee pricing that the new wind plants in the HVDC will be connected as close to 400/110 kV substations as possible or directly to the substations. As can be seen from the results of the network capacity simulations, this connection mode is the most suitable, if the electrical distance from the wind plant to the 400/110 kV substation is shorter, when the plant is connected directly to the substation than, when the plant is connected to 400/110 kV substation via existing 110 kV substation. However, with the connection mode DSM can be used poorly to increase the wind power capacity of the network. Consequently, as the simulations have shown, when the electrical distances with these two connection modes are nearly at the same level, the connection mode, where the plant is connected to the existing 110 kV substation, seems to be slightly better. In addition, with the connection mode, DSM can be used effectively to increase the wind power capacity of the network and reduce the curtailment of the wind power which will increase the energy efficiency of the wind power. Moreover, the power losses of the HVDC are lower with the connection mode. For these reasons, Fingrid should consider in its 110 kV network planning that whether it would be reasonable in some situations to connect the wind plants in 110 kV networks to the existing 110 kV substations instead of 400/110 kV substations. Moreover, it is essential to connect the wind plants to the vicinity of the loads, if DSM is intended to be used in the managing of the fluctuations in the wind power production in the future.

## 5. CONCLUSIONS

The purpose of the thesis was to describe the general planning principles of the HVDNs and to analyze the effects of large-scale wind power production on the different types of HVDNs. This was accomplished by making a literature survey about the subject, carrying out some interviews with network operator personnel and performing illustrative network simulations with the network test system containing wind power.

In Finland, the HVDNs include all 110 kV network lines, which are not part of the transmission network of Fingrid. In 2010, the length of the HVDNs was about 8262 km and the networks were possessed by 66 different network operators. The structure and role of the networks varied between the owners but, generally, the role was minor in the business operations of the owners. However, it was noted in the thesis that the increasing amount of wind power in the HVDNs will probably emphasize the role in the future, since the planning needs of the networks will increase.

The general planning of electricity networks is generally an optimization task between the investment costs, costs of losses, outage costs and maintenance costs, which means that in the planning the costs of the network are minimized in terms of the reliability, power quality and safety of the network. The boundary conditions of the planning determine the required level of the reliability, power quality and safety. At the moment, the reasonable pricing regulation model of Energy Market Authority highlights the reliability and power quality as a boundary condition of the planning.

It was revealed that the planning of the HVDNs is currently performed mainly by Fingrid, because changes in the HVDNs affect on the transmission network, which is why Fingrid wants to control the planning and operation of the HVDNs. In addition, only Fingrid has the sufficient calculation model, which covers the entire Finnish transmission network and all 110 kV lines, for the HVDN planning in the case when the transmission network must be considered in the plans.

Wind power causes many kinds of effects on the HVDNs. These effects are aimed to be reduced by the strict interconnection laws and regulations of wind power. In Finland, the regulations are determined by Fingrid. The regulations require that the wind plants in the HVDN participate in the network's voltage control, are equipped with a large reactive power capacity and withstand considerable voltage and frequency fluctuations without disconnecting from the network.

The simulation of the thesis examined the wind power capacity of the different types of HVDNs, the variability of the load and wind power production in relation to each other, the voltage variations and power losses in the HVDNs with wind power and, finally, the effects of DSM on the wind power capacity, voltages and power losses of the networks. The simulations were carried out with Power World simulation software with the actual measured hourly data of the wind power production and network loads

to simulate the hourly fluctuations of the power flows and voltages in the HVDC test system.

On the basis of the literature survey, interviews and simulations, the wind plants in the HVDC will increase the power and voltage fluctuations in the networks. This means that all wind and load situations should be considered in the network planning. In addition, the dimensioning and operation of the network becomes more complicated, since the dimensioning situations of the network might be more severe but rare, and the situations could possibly be handled by curtailing the wind power production or by DSM. Moreover, wind power will probably increase the power losses of the HVDC and the optimizing of the losses becomes more complicated due to the fluctuations in the power flows of the network. Eventually, the effects of wind power on the planning and operation of the HVDCs depend significantly on the selection of the connection mode of wind power and, therefore, the planning should be made carefully considering all the possible connection modes.

The planning resources of Fingrid are unlikely to be sufficient when the amount of wind power increases in the HVDCs in the future. Therefore, Fingrid may need to raise its fees or the HVDC planning must be outsourced to some other parties. In addition as the simulations of the thesis showed, Fingrid should consider in its 110 kV network planning that whether it would be reasonable in some situations to connect the wind plants in 110 kV networks so that there would be more load in the vicinity of the plants, especially if DSM was used in the managing of the fluctuations in the network.

## REFERENCES

ABB. 2009. Toward a smarted grid, ABB's Vision for the power system of the future. White paper. 8 p.

Bastman, J. 2011. Kartoitus alueverkkojen nykytilasta. Tampere University of Technology. Research report, SGEM-project. 48 p.

Bastman, J. 2012. SVT-4200 Sähköverkkojen mallintaminen ja analyysi, Modelling and analysis of electrical networks, study materials 2012. Tampere University of Technology, Department of Electrical Energy Engineering.

Cigre. 1995. Interaction between transmission and distribution system planning. Cigre/Cired WG CC 01 (Cigre 37.07-Cired 6). October, 1995. 134 p.

Energy Market Authority. 2007. Electricity Market Act 386/1995 including changes 1018/1995, 332/1998, 138/1999, 466/1999, 623/1999, 444/2003, 1130/2003, 1172/2004, 624/2007, 1326/2007. 18 p.

Energy Market Authority. 2010a. Selvitys Suomen kanta- alue- ja jakeluverkkojen rajauksesta ja ehdotus rajauskriteereiksi. 5.3.2010. Pöyry Management Consulting Oy. 33 p.

Energy Market Authority. 2010b. Sähköverkkotoiminnan tunnusluvut vuodelta 2010 [statistics]. [Cited 14.5.2012] Available at: <http://www.energiamarckkinavirasto.fi/data.asp?articleid=2647&pgid=69&languageid=246>.

Energy Market Authority. 2011. Sähkön jakeluverkkotoiminnan ja suurjännitteisen jakeluverkkotoiminnan hinnoittelun kohtuullisuuden valvontamenetelmien suuntaviivat vuosille 2012-2015. 29.6.2011. 84 p.

ENTSO-E. 2010. Impact of increased amounts of renewable energy on Nordic power system operation. 31.8.2010. Research report. 25 p.

ENTSO-E. 2011. Draft Requirements for Grid Connection Applicable to all Generators. 22.3.2011. Draft. 83 p.

EWEA. 2005. Large scale integration of wind energy in the European power supply: analysis, issues and recommendations. Research report. 172 p.

- EWEA. 2010. Powering Europe: wind energy and the electricity grid. Research report. 179 p.
- Fingrid Oyj. 2007a. Fingrid Oyj:n Yleiset liittymisehdot (YLE 2007). 31.8.2007. 4 p.
- Fingrid Oyj. 2007b. Voimalaitosten järjestelmätekniset vaatimukset (VJV 2007). 4.6.2007. 7 p.
- Fingrid Oyj. 2010. Tuulivoimapuiston liittäminen kantaverkkoon, Fingrid Oyj:n ohjeet ja vaatimukset. 30.8.2010. 10 p.
- Fingrid Oyj. 2011. Voimalaitosten järjestelmätekniset vaatimukset tuulivoimalaitosprojektin yhteydessä. 21.12.2011. 21 p.
- Fingrif Oyj. 2012. Kantaverkon liittymismaksu. 17.1.2012. 4 p.
- Finnish Wind Power Association. 2012. Wind power projects in Finland. [WWW]. [Cited 14.5.2012] Available at: <http://www.tuulivoimayhdistys.fi/hankkeet>.
- Hashmi, M. 2011. Survey of smart grids concepts worldwide. VTT Technical Research Centre of Finland. Research report. 56 p.
- Holtinen, H., Meibom, P., Orths, A., van Hulle, F., Lange, B., O'Malley, M., Pierik, J., Ummels, B., Tande, J.O., Estanqueiro, A., Matos, M., Gomez, E., Söder, L., Strbac, G., Shakoor, A., Ricardo, J., Smith, J.C., Milligan, M., Ela, E. 2009. Design and operation of power systems with large amounts of wind power. Final report, IEA WIND Task 25, Phase one 2006-2008. Espoo 2009. VTT Tiedotteita - Research Notes 2493. 239 p.
- Jussila, J. 2002. Sähköjakaiverkon yleissuunnittelumenetelmien kehittämisperiaatteet. Master of Science Thesis, Tampere, TTKK, Institute of Power Engineering. 138 p.
- Järventausta, P., Repo, S., Rautiainen, A., Partanen, J. 2010. Smart grid power system control in distributed generation environment. The International Federation of Automatic Control (IFAC). Annual Reviews in Control. Volume 34. Issue 2. pp. 277-286.
- Lakervi, E., Partanen, J. 2009. Sähköjakaiverkoteknikka. 2nd revised edition. Helsinki, Gaudeamus Helsinki University Press Oy Yliopistokustannus. 295 p.
- Matilainen J. 2011. Tuulivoima. S-18.3201 Sähkönsiirtojärjestelmät 2, study materials. 24.2.2011. Aalto University. 59 p.

Mäki, K. 2011. Tuulivoiman vaikutukset sähköverkossa. SMG-4500 Tuulivoima, study materials. 19.4.2011. Tampere University of Technology. VTT. 31 p.

Nordel. 2007. Nordic Grid Code 2007. 189 p.

Partanen, J. 2011. Tuulivoiman verkkoliityntä, perusteet. BL20A1200 Tuuli- ja aurinkovoimateknologia ja liiketoiminta, study materials. 15.3.2011. Lappeenranta University of Technology. 36 p.

Pihkala, A. 2009. Helsingin 110 ja 400 kV sähkönsiirtoverkon kehittäminen. Master of Science Thesis, Helsinki, Helsinki University of Technology, Department of Electrical and Communications Engineering. 180 p.

Piwko, R., Bai, X., Clark, K., Jordan, G., Miller, N., Zimberlin, J. 2005. The effects of integrating wind power on transmission system planning, reliability and, operations. Albany, NY. GE Energy, Energy Consulting. Research report. 171 p.

PowerWorld Corporation. 2012. PowerWorld Simulator. [WWW]. [Cited 14.5.2012] Available at: <http://www.powerworld.com>.

Reilander, A. 2012a. Alueellinen verkostosuunnittelu. S-18.3201 Sähkönsiirtojärjestelmät 2, study materials. 10.2.2010. Aalto University. 80 p.

SFS 6001. 2009. Finnish Standards Association SFS. High voltage electrical installations. 118 p.

SFS-EN 50160. 2011. Finnish Standards Association SFS. Voltage characteristics of electricity supplied by public electricity networks. 64 p.

Tuulivoimalaitosten järjestelmätekniiset vaatimukset. 2011. In work: Fingrid. Voimalaitosten järjestelmätekniiset vaatimukset (VJV 2007). 19 p.

Vierimaa, H. 2007. Verkkotietojärjestelmän kehittämistarpeet yleissuunnittelun näkökulmasta. Master of Science Thesis, Espoo, TKK, Department of Electrical and Communications Engineering. 101 p.

VJV-vaatimusten referenssipisteen määrittelyperiaatteet. 2011. In work: Fingrid. Voimalaitosten järjestelmätekniiset vaatimukset (VJV 2007). 5 p.

## **Interviews**

Elenia Verkko Oy. 2012. Lammi, H., Paasikivi, V., Mäkelä, T. Tampere. Interview, 8.2.2012.

Kuusela, A. 2012. Planning Engineer. Fingrid Oyj. Helsinki. Interview, 23.3.2012.

Reilander, A. 2012b. Network planner, Fingrid Oyj. Helsinki. Interview, 23.3.2012.

# APPENDIX 1 - HV DN NETWORK TEST SYSTEM

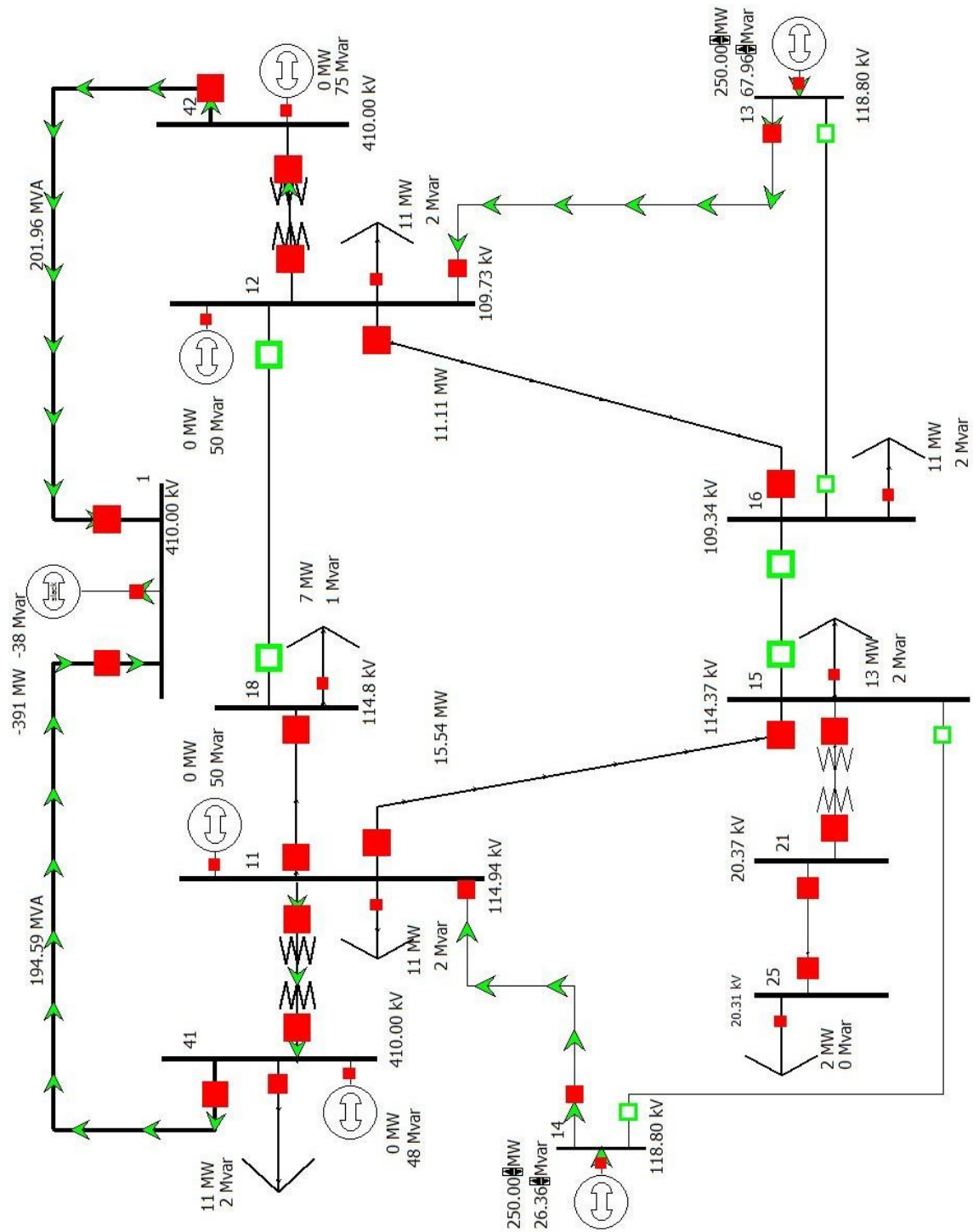



## APPENDIX 2 - INTRODUCTION OF HVDN NETWORK TEST SYSTEM

There are two types of lines in the test system network. All the 400 kV lines are 3-Finch conductors and all the 110 kV lines are 2-Duck conductors. The 20 kV line of the test system has been modelled using only the reactance of the typical 20 kV conductor, Al132 conductor, which is 0.346  $\Omega$ /km. The characteristic values of resistance, reactance and susceptance for 3-Finch and 2-Duck conductors, which have been used in the test system, are being listed in Table A2.1.

*Table A2.1. The characteristic values of the conductors. (Bastman 2012)*

Conductor	Resistance (r) $\Omega$ /km	Reactance (x) $\Omega$ /km	Susceptance (b) $\mu$ S/km
3-Finch	0.0171	0.291	4.04
2-Duck	0.05	0.30	3.79

Since the network calculation programs, like Power World simulation software, use per-unit (pu) values in calculations, the parameters of the network components must be entered in pu values. Using the pu values simplifies the calculations because the magnitudes of the values are equal regardless of the voltage level. Consequently, 100 MVA has been determined as a three-phase base power of the test system. The base voltages of the system are 400 kV, 110 kV and 20 kV. The base impedances of the system can be calculated with the base power and base voltages using equation (A2.1).

$$Z_b = \frac{U_b^2}{S_b} \quad (\text{A2.1})$$

Where

$Z_b$  is the base impedance

$U_b$  is the base voltage

$S_b$  is the base power

The calculated base impedances of the test system are being listed in Table A2.2. The base impedances are used in converting the characteristic values of the lines to the pu values. The resistance and reactance of the line can be converted to the pu value by dividing them by the base impedance of the line voltage level. On the contrary, the susceptance of the line can be converted by multiplying it by the base impedance. In addition, these results must be multiplied by the length of the line in kilometres in order to resolve the final parameters of the lines in pu values which are being entered to Power World simulator.

**Table A2.2.** *The base values of the test system.*

Base voltage kV	Base impedance $\Omega$
400	1600
110	121
20	4

The network test system used in this thesis has been divided into three different cases regarding to the lengths of the network lines. However, only the lengths of the lines 11-15 and 12-16 as well as the lengths of the connection lines of the wind farms differ from case to case while all the other lines of the network remain identical in all cases. The lengths of the lines as well as the resistances, reactances and susceptances of lines, which have been used in these simulations, are being presented in Table A2.3.

**Table A2.3.** *The parameters of the lines in the test system.*

Line	Length km	Resistance pu	Reactance pu	Susceptance pu
<b>All Cases</b>				
1 - 41	100	0.00107	0.01819	0.6464
1 - 42	100	0.00107	0.01819	0.6464
11 - 18	50	0.02066	0.12397	0.0229
12 - 18	50	0.02066	0.12397	0.0229
15 - 16	20	0.00826	0.04959	0.0092
21 - 25	10	0.00000	0.86500	0.0000
<b>Case 1</b>				
11 - 15	60	0.02479	0.14876	0.0275
11 - 14	70	0.02893	0.17355	0.0321
12 - 16	100	0.04132	0.24793	0.0459
12 - 13	110	0.04545	0.27273	0.0504
14 - 15	30	0.01240	0.07438	0.0138
13 - 16	30	0.01240	0.07438	0.0138
<b>Case 2</b>				
11 - 15	60	0.02479	0.14876	0.0275
11 - 14	50	0.02066	0.12397	0.0229
12 - 16	100	0.04132	0.24793	0.0459
12 - 13	70	0.02893	0.17355	0.0321
14 - 15	30	0.01240	0.07438	0.0138
13 - 16	30	0.01240	0.07438	0.0138
<b>Case 3</b>				
11 - 15	50	0.02066	0.12397	0.0229
11 - 14	50	0.02066	0.12397	0.0229
12 - 16	70	0.02893	0.17355	0.0321
12 - 13	70	0.02893	0.17355	0.0321
14 - 15	10	0.00413	0.02479	0.0046
13 - 16	10	0.00413	0.02479	0.0046

There are three transformers in the test system, two 400/110 kV transformers and one 110/20 kV transformer. All of the transformers have been modelled as two-winding transformers so that the system remains simple. However, especially the 400/110 kV transformers in the electric networks are in practise always three-winding transformers. Moreover, since the simulations of this thesis contain only power flow calculations, the vector groups of the transformers do not affect on the simulations. Solely, the resistances and reactances of the transformers have an influence on the simulations. For simplicity, the transformers have been assumed to be completely reactive and, therefore, only the series reactances of the transformers have been modelled in the test system. Usually, the transformers are equipped with a tap changer, in which case the voltage control of the network can be performed by changing the transformation ratio of the transformer. However, the transformers of the test system have conveniently selected constant transformation ratios because the voltage control of the system has been performed by using only generators. The voltage control of the network and the selection criteria of the transformation ratios are described later. The parameters of the transformers have been listed in Table A2.4.

**Table A2.4.** *The parameters of the transformers in the test system.*

<b>Voltages kV</b>	<b>Buses</b>	<b>Resistance pu</b>	<b>Reactance pu</b>	<b>Tap Ratio</b>
400/110	41 - 11	0	0.20	0.90
400/110	42 - 12	0	0.20	0.90
110/20	15 - 21	0	0.10	0.98

There are seven load points in the test system, one in 400 kV network, five in 110 kV network and one in 20 kV network. The total maximum real power of the loads is 300 MW. The reactive power of each load point is constantly 15 % of the real power. In addition to the maximum load situation, the simulations consider the situation of the minimum load. The minimum load of the test system has been determined with the real measured load data of one distribution network operator (DNO). It was found that the minimum load of the DNO is about 22.1 % of the maximum load. Consequently, the total minimum real power load and reactive power load of the test system are about 66.4 MW and 9.95 MVar, respectively. The loads of the test system have been listed in Table A2.5.

**Table A2.5.** *The loads of the test system.*

<b>Bus</b>	<b>Max Load MW</b>	<b>Max Load MVar</b>	<b>Min Load MW</b>	<b>Min Load MVar</b>
41	50	7.5	11.06	1.66
11	50	7.5	11.06	1.66
12	50	7.5	11.06	1.66
18	30	4.5	6.63	1.00
15	60	9.0	13.27	1.99
16	50	7.5	11.06	1.66
25	10	1.5	2.21	0.33
<b>Total</b>	<b>300</b>	<b>45</b>	<b>66.35</b>	<b>9.96</b>

There are in total seven generators in the test system, three in 400 kV network and four in 110 kV network. 400 kV generators are located so that there is a generator in each 400 kV bus. The terminal voltage of 400 kV generators is 1.025 pu, which is 410 kV as actual value. Bus 1 is the reference bus of the test system, which means that the generator's voltage in Bus 1 is constant and the generator balances the power of the network, so that a deficit or surplus in the real or reactive power of the network is produced or consumed by the generator. On the contrary, the generators in Bus 41 and 42 do not produce or consume any real power, but only aim to keep their voltage at 1.025 pu by adjusting their reactive power. Both the maximum reactive power production and consumption of one generator are set to 100 MVar.

Two of 110 kV generators are located in Buses 11 and 12. These generators have been added to adjust the voltages of the 110 kV busbars in the secondary circuits of the 400/110 kV transformers. Originally, the plan was that the voltage control of the 110 kV busbars would have been performed, as it is usually done in an actual network, by using the tap changers of the transformers and possibly parallel-connected capacitors. However, it was noticed that the simulations function better and the test system is simpler, if the voltage control of the tap changer and capacitors are modelled with one generator which aims to keep its voltage at 1.08 pu (118.8 kV). Therefore, the transformation ratios of the transformers are constantly 0.9, which is also the best transformation ratio for the worst case situation in the test system. Additionally, it was decided that the size of the capacitor units would be 50 MVar which is a realistic size in terms of an actual network (Kuusela 2012). Consequently, the maximum reactive power production of one generator was set to 50 MVar. However, since the transformation ratio of the transformers is 0.9 in all situations, the voltages of the 110 kV busbars are too high in low load situations. On this basis, the generators of the Buses 11 and 12 are allowed to consume up to 50 MVar of reactive power if necessary, which will lower the voltages of the 110 kV busbars.

The other two of 110 kV generators are the generators which model the wind farms. The nominal power of the generators is 250 MW which is approximately the maximum size of the wind farm which would be connected to the HVDN in Finland. The voltage control of the generators has been implemented by taking account the latest connection

regulations of Fingrid. Therefore, the control has been carried out using the constant voltage control. Consequently, the generators have been set to keep their bus voltage, which would probably be the VJV reference point in the case of an actual network, at 1.08 pu (118.8 kV) by adjusting their reactive power. The reactive power limits of the generators are set on the basis of the current regulations (Tuulivoimalaitosten järjestelmätekniiset vaatimukset 2011). Consequently, the generators can adjust their reactive power continuously from production to consumption as long as the power factor of the generator is between 0.95 cap - 0.95 ind, which means that the reactive power capacity of the generators is the higher the greater is the real power production of the generator.

In conclusion, the properties of the generators in the test system have been listed in Table A2.6.

*Table A2.6. The generators of the test system.*

<b>Bus</b>	<b>Desired bus voltage pu</b>	<b>Real power capacity MW</b>	<b>Reactive power capacity MVar</b>
1	1.025	Unlimited	Unlimited
41	1.025	0	0 - 100
42	1.025	0	0 - 100
11	1.08	0	-100 - 100
12	1.08	0	-100 - 100
13	1.08	0 - 250	-82.2 - 82.2
14	1.08	0 - 250	-82.2 - 82.2

# APPENDIX 3 - NETWORK CAPACITY SIMULATIONS

*Table A3.1. Results of Case 1 network capacity simulations.*

Operation mode (o=open, c=closed)	P <sub>14</sub> MW	Q <sub>14</sub> Mvar	P <sub>13</sub> MW	Q <sub>13</sub> Mvar	P <sub>total</sub> MW	P <sub>total,max</sub> - P <sub>total,min</sub> MW	P <sub>total,max</sub> + P <sub>total,min</sub> MW	Dimensioning factor
<b>18-12 o, 15-16 o</b>								
minimum load	230	24.6	200	28.2	430			U11 and U12
maximum load	260	27.8	240	42.5	500	70	930	load capacity of lines and U12
<b>18-12 o, 15-16 c</b>								
minimum load	210	26.8	220	24.6	430			U11
maximum load	250	39.4	260	34.9	510	80	940	U11 and load capacity of lines
<b>18-12 c, 15-16 c</b>								
minimum load	220	29.8	220	27.0	440			U11
maximum load	260	41.4	260	38.2	520	80	960	load capacity of lines
<b>14-11 c, 12-13 o, 18-12 o, 15-16 o</b>								
minimum load	240	19.0	200	28.2	440			U11 and U12
maximum load	250	24.8	240	42.5	490	50	930	U11 and U12
<b>14-11 c, 12-13 o, 18-12 o, 15-16 c</b>								
minimum load	190	15.3	260	23.5	450			U11 and load capacity of lines
maximum load	230	20.2	260	29.8	490	40	940	U11 and load capacity of lines
<b>14-11 c, 12-13 o, 18-12 c, 15-16 c</b>								
minimum load	210	17.1	260	24.5	470			U11 and load capacity of lines
maximum load	260	25.6	260	28.1	520	50	990	load capacity of lines
<b>14-11 o, 12-13 c, 18-12 o, 15-16 o</b>								
minimum load	230	24.6	210	27.1	440			U11 and U12
maximum load	260	27.8	210	27.1	470	30	910	load capacity of lines and U12
<b>14-11 o, 12-13 c, 18-12 o, 15-16 c</b>								
minimum load	260	15.0	180	18.4	440			load capacity of lines and U12
maximum load	260	22.9	210	27.3	470	30	910	load capacity of lines and U12
<b>14-11 o, 12-13 c, 18-12 c, 15-16 c</b>								
minimum load	260	20.7	200	26.0	460			load capacity of lines and U12
maximum load	260	23.6	240	41.8	500	40	960	load capacity of lines and U12
<b>14-11 c, 12-13 c, 18-12 o, 15-16 o</b>								
minimum load	240	19.0	210	27.1	450			U11 and U12
maximum load	250	24.8	210	27.1	460	10	910	U11 and U12
<b>14-11 c, 12-13 c, 18-12 o, 15-16 c</b>								
minimum load	250	23.5	210	28.8	460			U11 and U12
maximum load	250	24.3	210	26.9	460	0	920	U11 and U12
<b>14-11 c, 12-13 c, 18-12 c, 15-16 c</b>								
minimum load	250	22.6	210	28.3	460			U11 and U12
maximum load	250	24.4	220	33.2	470	10	930	U11 and U12

**Table A3.2. Results of Case 2 network capacity simulations.**

Operation mode (o=open, c=closed)	P <sub>14</sub> MW	Q <sub>14</sub> Mvar	P <sub>13</sub> MW	Q <sub>13</sub> Mvar	P <sub>total</sub> MW	P <sub>total,max</sub> - P <sub>total,min</sub> MW	P <sub>total,max</sub> + P <sub>total,min</sub> MW	Dimensioning factor
<b>18-12 o, 15-16 o</b>								
minimum load	230	24.6	200	28.2	430			U11 and U12
maximum load	260	27.8	240	42.5	500	70	930	U11 and U12
<b>18-12 o, 15-16 c</b>								
minimum load	170	28	260	27.2	430			U11 and load capacity of lines
maximum load	250	39.4	260	34.9	510	80	940	U11 and load capacity of lines
<b>18-12 c, 15-16 c</b>								
minimum load	180	30.6	260	29.6	440			U11 and load capacity of lines
maximum load	260	41.4	260	38.2	520	80	960	load capacity of lines
<b>14-11 c, 12-13 o, 18-12 o, 15-16 o</b>								
minimum load	260	14.5	200	28.2	460			load capacity of lines and U12
maximum load	260	10.8	240	42.5	500	40	960	load capacity of lines and U12
<b>14-11 c, 12-13 o, 18-12 o, 15-16 c</b>								
minimum load	210	16.3	260	24	470			U11 and load capacity of lines
maximum load	260	19.8	260	30.6	520	50	990	U11 and load capacity of lines
<b>14-11 c, 12-13 o, 18-12 c, 15-16 c</b>								
minimum load	230	16.4	260	25.3	490			U11 and load capacity of lines
maximum load	260	10	260	24.9	520	30	1010	load capacity of lines
<b>14-11 o, 12-13 c, 18-12 o, 15-16 o</b>								
minimum load	230	24.6	240	20.6	470			U11 and U12
maximum load	260	27.8	250	24.3	510	40	980	load capacity of lines and U12
<b>14-11 o, 12-13 c, 18-12 o, 15-16 c</b>								
minimum load	260	18.3	210	16.6	470			load capacity of lines and U12
maximum load	260	24.5	250	23.7	510	40	980	load capacity of lines and U12
<b>14-11 o, 12-13 c, 18-12 c, 15-16 c</b>								
minimum load	260	22.8	230	21.1	490			load capacity of lines and U12
maximum load	260	20.9	260	20.9	520	30	1010	load capacity of lines
<b>14-11 c, 12-13 c, 18-12 o, 15-16 o</b>								
minimum load	260	14.5	240	20.6	500			load capacity of lines and U12
maximum load	260	10.8	250	24.3	510	10	1010	load capacity of lines and U12
<b>14-11 c, 12-13 c, 18-12 o, 15-16 c</b>								
minimum load	260	13.5	240	20.9	500			load capacity of lines and U12
maximum load	260	14	260	27.8	520	20	1020	load capacity of lines and U12
<b>14-11 c, 12-13 c, 18-12 c, 15-16 c</b>								
minimum load	260	15.6	250	24.8	510			load capacity of lines and U12
maximum load	260	14.1	260	25.2	520	10	1030	load capacity of lines

**Table A3.3. Results of Case 3 network capacity simulations.**

Operation mode (o=open, c=closed)	P <sub>14</sub> MW	Q <sub>14</sub> Mvar	P <sub>13</sub> MW	Q <sub>13</sub> Mvar	P <sub>total</sub> MW	P <sub>total,max</sub> - P <sub>total,min</sub> MW	P <sub>total,max</sub> + P <sub>total,min</sub> MW	Dimensioning factor
<b>18-12 o, 15-16 o</b>								
minimum load	260	21.1	230	19.8	490			load capacity of lines and U12
maximum load	260	4.4	260	19.8	520	30	1010	load capacity of lines
<b>18-12 o, 15-16 c</b>								
minimum load	240	26.5	260	20.7	500			U11 and load capacity of lines
maximum load	260	13.9	260	6.5	520	20	1020	load capacity of lines
<b>18-12 c, 15-16 c</b>								
minimum load	240	25.8	260	19.4	500			U11 and load capacity of lines
maximum load	260	10.6	260	5.9	520	20	1020	load capacity of lines
<b>14-11 c, 12-13 o, 18-12 o, 15-16 o</b>								
minimum load	260	14.8	230	19.8	490			load capacity of lines and U12
maximum load	260	10.3	260	19.8	520	30	1010	load capacity of lines
<b>14-11 c, 12-13 o, 18-12 o, 15-16 c</b>								
minimum load	240	17.9	260	10	500			U11 and load capacity of lines
maximum load	260	11.5	260	15	520	20	1020	load capacity of lines
<b>14-11 c, 12-13 o, 18-12 c, 15-16 c</b>								
minimum load	260	19.4	260	13.5	520			U11 and load capacity of lines
maximum load	260	4.7	260	9.4	520	0	1040	load capacity of lines
<b>14-11 o, 12-13 c, 18-12 o, 15-16 o</b>								
minimum load	260	21.1	240	21.5	500			load capacity of lines and U12
maximum load	260	4.4	250	24	510	10	1010	load capacity of lines and U12
<b>14-11 o, 12-13 c, 18-12 o, 15-16 c</b>								
minimum load	260	0.74	220	17.2	480			load capacity of lines and U12
maximum load	260	15.5	260	24.8	520	40	1000	load capacity of lines
<b>14-11 o, 12-13 c, 18-12 c, 15-16 c</b>								
minimum load	260	10.7	250	25.9	510			load capacity of lines and U12
maximum load	260	8.6	260	18.5	520	10	1030	load capacity of lines
<b>14-11 c, 12-13 c, 18-12 o, 15-16 o</b>								
minimum load	260	14.8	240	21.5	500			load capacity of lines and U12
maximum load	260	10.3	250	24	510	10	1010	load capacity of lines and U12
<b>14-11 c, 12-13 c, 18-12 o, 15-16 c</b>								
minimum load	260	14.2	240	21.4	500			load capacity of lines and U12
maximum load	260	13.6	260	27.3	520	20	1020	load capacity of lines and U12
<b>14-11 c, 12-13 c, 18-12 c, 15-16 c</b>								
minimum load	260	16.4	250	25.3	510			load capacity of lines and U12
maximum load	260	13.3	260	25.2	520	10	1030	load capacity of lines