

Haptics in Kiosks and ATMs for the Disabled

Ahmed Farooq

University of Tampere
Department of Computer Sciences
Computer Science
Haptic Communication & Interaction
Supervisor: Roope Raisamo
September 2009

Contents

Abstract

1. Introduction	5
2. Physiology of Touch	8
3. Accessibility and Impairment.....	11
3.1. Traumatic Injuries.....	12
3.2. Diseases and Congenital Conditions.....	13
3.2.1 Muscular Dystrophy.....	13
3.2.2 Spina Bifida.	14
3.2.3 Arthritis.....	15
3.2.4 Parkinson’s Disease.	16
3.2.5 Essential Tremor.	16
4. Research in ATMs and Public Kiosks.....	18
4.1. A Model for Multisensory Interaction	19
4.2. Commercial Research at Immersion Corporation.....	20
4.3. Research at TAUCHI.....	20
4.4. MATCHKiosk :A Multimodal Interactive City Guide.....	23
4.5. User Friendly Touch Screens	25
5. Commercial Products	26
5.1 Talking Finger Print Technique.	26
5.1.1 Talking Finger Print.....	26
5.1.2 I Am Hearer.	28
5.2 Haptics and Security.	28
5.2.1 Haptics-Based Graphical Password.	28
5.2.2 Siemens Haptic ID Card.	30
5.2.3 Mobile Haptic Kiosk Access	31
5.3 Electronic Voter Kiosks.....	31
5.4 Public Haptic Kiosks.....	33
5.4.1 VFIT Kiosk.	33
5.4.2 Vectra ATM.....	33
5.4.3 Health Information Portal (HIP).	34
6. Requirement Research for PCM Design for the Disabled.....	36
6.1. Research Guidelines and Market Trends.....	36
6.2. Target Audience and Requirement Elicitation Process	37
6.3. Surveys and Data Collection.....	37
6.4. Results and Analysis.....	38
7. Hardware and Software Alteration Proposals	41
8. Redesign of Hardware Structure	45
8.1. Redesign Motivation.....	45

8.2.	Core Hardware Structure and Processes	45
8.2.1	Braille Function.	47
8.2.2	Selection Panel.....	48
8.2.3	Haptic Selection Buttons.....	48
8.3.	Implementation of Haptic Selection Buttons	49
8.4	Selection Panel Hardware Overview.	48
8.4.1	Atmel AT89C51 Description.....	51
8.4.2	Atmel 89C51 Incircuit Programming	52
8.4.3	Programmed Code Overview.....	53
8.4.4	Modular System Overview.	55
8.5.	Evolutionary Survey and Results.....	57
9.	Discussion and Future Research.....	61
	Summary.....	65
	References	67
	Appendix	72

Abbreviations:

AT89C51 – Atmel Corporation Microcontroller 89C51

ET – Essential Tremors

MD – Muscle Dystrophy

GHP – Graphical Haptic Password

HIP – Health Information Portal

HCI – Human Computer Interaction

IC – Immersion Corporation

MATCH Kiosk, – Multimodal Access to City Help Kiosk

MC – Microcontroller

NFC – Near Field Communication

PCM – Public Computing Machines

IKs – Information Kiosks

TAUCHI – Tampere Unit for Computer-Human Interaction

UIs – User Interfaces

VFIT – Virtual Fit

VRS – Virtual Reality Systems

Abstract

Current information kiosks and ATMs are designed to facilitate users by providing a single modal interaction approach. They are generally accessed and operated via a small touch screen and a basic numberpad. Considering that most Information kiosks and ATMs are located in congested and low lit areas, it becomes a usability challenge for users to operate such machines. As such kiosks become more and more complex and multifaceted their usability begins to fall considerably, even for experienced users. In this situation we see that disabled users, who often require the services of such kiosks the most, are facing serious accessibility issues which limit, and in some cases outright restrict the usage of such machines. For much of this evolution of IKs and ATMs, the disabled users accessibility and usability concerns have gone unheard, giving rise to a technology bias and hence the current form of such machines, where touch screen are quickly replacing all mechanical buttons and keypads. The impact of this evolution has left scarring effects for most disabled users. This research aims to understand the gap created by the advancements in IKs and ATMs, and provide a working design using a multimodal approach to bridge this gap. The research also tries to explore some of the ongoing efforts to design and implement IKs and ATMs for the disabled as well as some commercial products which have surfaced to facilitate the target users.

1. Introduction

Technology in Public Computing Machines (PCMs) has advanced to such a degree that managing these advances has become a challenge on its own. A multitude of techniques and usability concerns need to be followed to ascertain the desired results, especially for public kiosks. The complexity of design gives rise to further difficulty in usability or in certain cases a complete abdication of the laws of natural interaction. Thus users have to remember a course of action to perform, instead of naturally evaluating the responses generated, to responses required. Therefore, it is becoming more and more challenging for users, to use PCMs that provide these unnatural interaction techniques. The user groups that suffer from such usability issues are often users that require the assistance of such machines the most. Among these groups, disabled users and senior citizens probably suffer due to the lack of ergonomic and tedious technical usability concerns of PCMs.

Most public machines like ATMs and IKs are designed to accommodate the maximum usability features for the largest user groups, but unfortunately the disabled and senior citizens are often minimized due to lesser use and lower numbers. The complicated and unnatural designs not only cause usability concerns, but in some cases, accessibility is also compromised. Blind and disabled users may have serious accessibility issues which may hinder or restrict use of such public machines. Haptics resolves such issues and provides a bridging effect for motor impaired and visually disabled users. It adds another somatosensory channel for Human Computer Interaction (HCI) that can prove to be critical.

Although as human beings we interact with our surroundings through five sensory channels sight, sound, taste, smell, and touch, it is only our sense of touch that enables us to modify and manipulate the world around us. Therefore, haptics provide another dimension in interaction with our surroundings. The study of haptics has grown dramatically with the advent of touch in computing, as many researchers are involved in the development, testing, and refinement of tactile and force feedback devices (simulating object hardness, weight, and inertia), along with supporting software, that allows users to sense or feel and manipulate three-dimensional virtual objects and more and more such interfaces are being designed for common PCMs.

Haptics is a research that is still surrounded by a bit of controversy. Because of this the needed research has taken a longer time to happen. In my view the biggest hindrance in perceiving virtual objects as real, is the lack of availability of Virtual Reality System (VRS). There are lesser affordable haptic devices available that can utilize the existing

VRs or the haptic applications available today, especially in mobile context. However, the advent of large touch screens in mobiles has created the niche for providing haptic feedback on data manipulation operations. The need for a more natural experience of mobile computing has set promising haptic designs in motion which will not only provide a more ergonomic usability experience but resolve accessibility issue for disabled and visually disabled users groups.

Nokia, Samsung LG, Blackberry and Apple are all moving closer to developing truly localized haptic computing devices, even OLPC foundation setup by UN is planning to add haptic feedback to their next generation laptops [24] which will enhance a more realistic experience for mobile users and provide an impetus to other haptic interface developers [2]. Besides, Immersion is closely working with Samsung and LG is now also working on PCMs to create a more haptic culture that didn't exist a few years ago [2].

Considering the amount of research and the prototype products available, it's interesting to note that there aren't many commercial products aimed at the disabled users. As specified earlier, that due to the low market share and the looming global financial slowdown, it might be sometime before the commercial sector sees any significant investment in this sector. In this thesis I will highlight some of the research that is being carried out to facilitate these user groups and to enhance the usability for existing users of PCMs. There is also an effort to introduce the current and future possible commercial products that may improve the PCM usability experience, in Chapter 5.

During this research it was also noted that there was a need to highlight the fundamental issues for the different facets of disabled users and their feedback on the limited assistance being provided to them. In this spirit, three different studies were carried out to understand the major issues experiences by the disabled users (Chapter 6). An effort was also made to segregate the term "disabled users", and highlight the different limitations these disabilities may cause in the accessibility and usability of PCMs (Chapter 3). A lot of research was conducted to understand the medical conditions behind the different types of disabilities and hence incorporate the finding in the proposed design. All these surveys were conducted in such a way as to limit the cultural/regional boundaries of technology, which might bias the results.

Using the results from these surveys an improved design was created to negate the current usability concerns, strongly voiced in the studies. This design incorporated the fundamental needs of most of the facets of the disabled audience without hindering usability for the common users. Most of the design was emulated with currently

available technologies, however, during this passage of design it was suggested to try to implement all such areas of the design which were unique and currently unperceivable as a product. Hence to validate the design a complete section was also implemented using prototype hardware, with necessary algorithm, and was demonstrated to ensure that the designed structure was not only functional, but provided results similar to the precious expectations, details of which are given in Chapter 8 and 9.

In effect this research was primarily targeted at labeling and defining exactly what usability and accessibility issues the different categories of disabled users faced. The research also tries to create a rationale for these issues and through careful prioritization of these issues, the research constructs a requirement specification deliverable for future development of IKs and ATMs. Moving a step further the research also tries to put forward a workable design prototype incorporating a multimodal approach to resolving the issues highlighted during the course of this study. To ensure that this design is viable and hence implementable, the prototype design was partially implemented and tested, by the same participants who defined the issues, originally. Hopefully this research can be a stepping stone to a more condusively intractable interface design to today's antiquated UI of IKs and ATMs.

2. Psychology of Touch

Touch has been considered as a personal medium of interaction, which hasn't been properly understood over the years. Most cultures around the world considering its study as Taboo; which has hindered the effective use of this greatly profitable human sense. Touch is considered as a sensual form of expression that feeds the other senses with metaphysical information which is required to facilitate their operations. Until recently, many forms of perception and representation of reality that were explicitly connected to vision have been proved to be the elements of touch [30].

Although touch is a very controversial and vastly debatable topic [34], with reference to this study we will consider the psychology of touch in light of facilitating the other senses. Until recently touch has been used as a facilitation sense but now this silent facilitator has been put to the test, as a primary sense of interaction with amazingly accurate results [34, 36]. The opportunity of using just the sense of touch to read, speak, and understand visual and audible constructs have amazed the scientific community, and now haptics is pushing the boundaries of touch even further.

The instruments of touch include but are not limited to the peripheral limbs, especially the hands, and fingers. If we consider touch as a set of activities yielding various sorts of information regarding the structure, state, and location of surfaces, substances, and objects in the environment, we use many sorts of haptic information to guide our activities, and it is the deconstruction of these activities that provide us with the true understanding of the capable power of touch. It is unfortunate that this true power is unrecognized until we lose it or we utilize it to overcome the loss of our other senses. Heller et al [32] provide compelling argument to this:

“We may become aware of our dependence on the sense of touch when something causes it to malfunction, and only then do we recognize its significance. Neither the leper nor the victim of diabetes doubts the importance of tactile input. Touch serves to warn us about impending or immediate danger, for example, via pain sensibility. In addition, our ability to manoeuvre in and explore the world as we do requires tactile input. This is obvious when we observe the relearning process as astronauts first walked on the moon. Even sitting utilizes tactile information, if only to tell us to shift our position. Our reliance on touch often goes unnoticed because of attention to visual perception, and because we tend to think of the performatory role of the hand rather than its sensing function (Gibson, 1962, 1966). We use our hands to obtain tactile information as well as to manipulate objects. However, much of our tactile

input comes from parts of the body other than our hands (see Stevens, 1990). The tendency to identify touch primarily with the hands, and the close linkage between performance and perception, may have contributed to this bias.”

It is important to understand why and when do we choose to employ touch superseding all other senses. It is the answer to this question that has researchers bemused [32, 36]. For us, it is integral to know what triggers the emotion and physical need to manipulate or experience an object through the means of touch, to empower us to be able design and implement true haptic interaction with machines.

Heller et al believe that cognitive effect of a tactile experience is fundamentally quite different in nature than any visual experience. Information gathered through tactile interaction is far more continuous and inherently personal. There is a connection between the entities of interaction due to the tactile exchange which enriches the communication process. He believes that haptic contact provides far more information than a visual glance and the information provided via the haptic channel has the ability to overload other streams of somatosensory channel as well as facilitate their respective functions.

Interestingly Heller et al put forward the notion that overloading the other senses via haptic interaction provides an extra sensory channel which unites the cognitive inputs ensuring multifaceted communication which cannot be achieved via any single somatosensory channel. The belief that haptics is the core or master sense which unites all sensory perceptions and limits their respective areas of influence may be somewhat new, but researchers have always associated mysticism and extra sensory perception (ESP) with “touch” [34]. There have been many efforts to encompass the area of influence for haptics, but every new research points towards Heller et al work [32]. They facilitate their claim by the simple principle of elimination. Some of us rely on our sense of touch far more than other, like visually challenged or the blind persons. They experience the visual impulses via tactile input stream, which not only provides an image to the visual cortex, but also facilitates it with personally referenced information. It is due to this unification of their visual and tactile streams they are able to read, write and inspect objects and parameters, tasks which are not associated with general tactile feedback. And the compelling argument doesn’t stop here. If the sense of touch can overload visual inputs (always considered to be mother of all senses) haptics can easily facilitate the audible connections. Deaf-blind people are probably the most conducive example of this research. People with very limited or no, special and acoustic information are able to generate ecological frames of references explicitly via tactile and haptic interaction is a pure example of sensory perception overload (SPO). [34].

Even in fictional literature examples for SPO have been commonly used like "*Johnny Got His Gun*," by Dalton Trumbo (1970), which described the plight of a veteran who lost almost all sensory input owing to physical trauma; Johnny could neither hear, nor see, nor speak, but learned to communicate with a nurse by tapping out Morse code with what little remained of his head. The nurse was able to talk to him by printing messages on the skin of his chest with her finger (pp. 197-199).

Another interesting debate that comes to light through the invariable comparison of the other senses to touch, vision in particular, is the acquisition of serial input, as compared to a parallel form of interaction with the surroundings. However, through recent research it has been proven without doubt [34], that not only through the sense of touch we are capable of acquiring *somatosensory* information through multiple channels and multiple frequencies, but the human brain can process all this information fast enough to associate any visual representation to it. In addition, touch and vision may not always operate in the same fashion [34]. Some researchers have emphasized limitations in touch, primarily because of the sequential nature of processing [34].

More recently, researchers have demonstrated word superiority effects in reading Braille [34]. This refers to the effect of faster and more accurate recognition of particular letters in a word than non words. However, in comparison visual clues may fasten the overall process of character and word recognition but it is limited by the need to associate words and letters to certain anchors, which Braille does not. However, Heller et al acknowledge that there are certain sensory experiences which are specific to either vision or touch, and there is no doubt that certain affective reactions are aroused by sight, which are not translatable to any other sense, like a majestic sunset, or a clear waterfall.

3. Accessibility and Impairment

There has always been an inherent gap between technology users and designers. Usability concerns take a back seat to the productivity of technology. Designers' ambition of making the science fiction, possible can more often than not, limit the produce, to a certain class or section of the population. This phenomenon has yielded to a technology bias which needs to be removed, to provide mass usability. The advent of haptics in UIs was hailed as such a milestone, which would aid in the homogeneous distribution of technology, removing the core hindrances that produced the inherent technology gap. Due to the natural and instinctive architecture of haptic communication, pre-understanding of computing systems is no longer the pinnacle of the technology spread. Most users can master any well structured system that follows natural or instinctive interaction principles, and haptics provides this platform of interaction with an intuitive response feed back mechanism which ensures usability with control.

The greatest strength of haptic communication' is the ability to compliment other modalities yet maintaining its unique attributes and advantages. This provides greater opportunity for simultaneous UI feedback through multiple modalities, encouraging a far more enriching HCI experience which was previously lacking. It is also now possible to utilize this multi-modal communication approach to expand the target audience, which were previously unable to enjoy the current technology boom, due to the lack of the fundamental limitations in their interaction; which were the basic of most HCI techniques. Hence, now we can design single computing systems which can facilitate users with disabilities, as well as mass users, by providing multiple interaction techniques, eliminating the ever so strong dependency on a single modality [41], which either required previous knowledge of operation or a perfect natural sense to ensure a pleasant HCI experience. To understand how advantageous a haptics based multimodal system can be for disabled user, we need to understand the type of disabilities of our target users, and provide a reliable UI structure which can facilitate such disabilities.

Whenever we talk about disabled users of any computing devices we always have two basics types of disabilities that greatly hinder use of computing devices, users with limited or no visual abilities, and users with limited or no motor abilities. There has been a lot of research and talk about how to design and construct systems for visually challenged users, where as users with limited motor abilities have been somewhat ignored. In this section I highlight the reasons for limited or completely diminished motor abilities and some of the assistive technologies that can be used to help the HCI process.

There are inherently two basic reasons for diminished motor abilities, either the subject has experienced a physical trauma for some sort, during an accident, or the subject is suffering from mental or physical ailment that triggers such disabilities.

3.1. Traumatic Injuries

Spinal cord injuries, as seen in Figure 3.1, can result in a state of paralysis of the limbs. Paralysis of the legs is called paraplegia. Paralysis of the legs and arms is called quadriplegia. According to research at the “Center for Persons with Disabilities” at “Utah State University” [27]

The leading causes of spinal cord injury are as follows:

- motor vehicle accidents: 44%
- acts of violence: 24%
- falls: 22%
- sports: 8%
- other: 2%. [27].



Fig 3.1: Spinal cord injury [27]

Individuals with paraplegia generally have no difficulty accessing computing machines. Individuals with quadriplegia, however, may have significant difficulties, depending on the type and severity of the injury. Some individuals with quadriplegia have some use of their hands, but not enough to, say, manipulate a mouse or type on a keyboard, and significantly touch panels or touch screen. Despite these limitations, individuals with quadriplegia are able to make use of assistive technologies that allow them to access the functionality of their computers or computing machines. [27]

Someone who has lost one hand will still be able to use computing machines without too much difficulty. One-handed keyboards are available, which can completely compensate for the lack of the other hand, at least as far as ATM access is concerned. However, someone who has lost both limbs may need to make use of other technologies, and PCM rarely employ such add-ons [27].

3.2. Diseases and Congenital Conditions

Cerebral palsy is an injury to the brain (which is why the term "cerebral" is used), resulting in decreased muscle control (palsy). The condition usually occurs during fetal development, but can also occur at or shortly after birth [27]. Common characteristics of cerebral palsy, as seen in Figure 3.2, include muscle tightness or spasm, involuntary movement, and impaired speech. Severe cases can lead to paralysis. [27]



Fig 3.2: Cerebral palsy [27]

Many people with cerebral palsy are able to use computers, but usually have a difficult time using a mouse. Their arm movements are often too jerky and unpredictable to use a mouse effectively. They can usually use a keyboard, or an adaptive keyboard, though more slowly than individuals without cerebral palsy. Often they will use keyboards with raised areas in between the keys, to allow them to place their hand on the raised area, then press their fingers down onto the key that they wish to type. Regular keyboards can be adapted to this same purpose by the use of keyboard overlays. This reduces the likelihood of errors while typing. [27]

3.2.1. Muscular dystrophy

Muscular dystrophy (MD) is a genetic disorder in which the genes for muscle proteins are damaged. It is characterized by the progressive degeneration of the muscles. Muscular dystrophy, as shown in Figure 3.3, can affect people at any age, but is most common in children. Individuals with mild MD can live a normal life span, while individuals with more serious cases can die in their teens or early 20s. The assistive technologies used by individuals with MD depend on the severity of the condition, but generally include the same technologies already mentioned (head wands, mouth sticks, adaptive keyboard, voice recognition software, etc.).

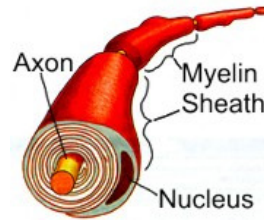

Fig 3.3: Multiple sclerosis [27]

In individuals with multiple sclerosis (MS), the myelin (a layer of fatty tissue which surrounds nerve fibers) erodes, rendering the nerve fibers incapable of sending signals from the central nervous system to the muscles of the body. The milder cases of MS can result in one or more of the following symptoms: tremors, weakness, numbness, unstable walking, spasticity, slurred speech, muscle stiffness, or impaired memory. Severe cases can result in partial or complete paralysis. Not all individuals with MS experience all of the symptoms and, interestingly, the same individual may experience different sets of symptoms at different times. The types of technologies used are the same as for other motor disabilities. [27]

3.2.2. Spina bifida

Spina bifida is a congenital condition in which the spine fails to close properly during the first month of pregnancy. This causes the membrane around the spinal column to protrude through the back, resulting in a visible bulge, or sac on the back of the individual. In the more serious cases, the spinal column itself protrudes through this opening. Individuals born with spina bifida will likely experience motor difficulties, and possibly paralysis. In some cases, fluid can accumulate in the brain, which may also cause damage to the brain. Some individuals experience learning and language difficulties as a result.

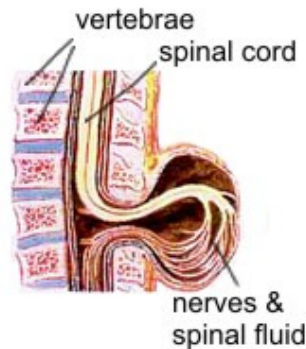

Fig 3.4: Amyotrophic lateral sclerosis (Lou Gehrig's Disease)

Sometimes called Lou Gehrig's disease, Amyotrophic lateral sclerosis (ALS) is a degenerative disease that prevents neurons from sending impulses to the muscles. The muscles weaken over time, and the condition may eventually affect the muscles required for breathing, resulting in death, as seen in the Figure 3.4. Symptoms include slowness in either movement or speech. The vast majority of cases of ALS are of unknown causes. About 5-10% of cases are genetically-linked. [27]

3.2.3. Arthritis

Arthritis occurs most often in the elderly, but can occur in younger individuals as well. Many people with arthritis are able to use a keyboard and mouse, but they do not always have the fine motor control sufficient to click accurately on small links, for example (see Figure 3.5). More often than not, people with arthritis do not use assistive technologies at all, but some with more advanced arthritis may use a trackball mouse, voice recognition software, or foot pedals. Joint pain can cause fatigue, and limit the amount of time that the person is willing to spend on a computer maneuvering a mouse and typing on a keyboard. [27]



Fig 3.5: Arthritis [27]

3.2.4. Parkinson's disease

Parkinson's disease (PD) is a disorder of the central nervous system that causes uncontrollable tremors and/or rigidity in the muscles as shown in Figure 3.6. Individuals with advanced cases of Parkinson's disease may not be able to use a mouse at all, and some are unable to use a keyboard. Sometimes the voice is affected as well, so that voice recognition software is not an option, though most people with PD have voices that are easily understood. Parkinson's disease is most likely to occur later in life, but can affect younger individuals as well. [27]



Fig 3.6: Parkinson's disease [27]

3.2.5. Essential tremor

Like Parkinson's disease, essential tremor (ET) is a nerve disorder that can result in uncontrollable tremors. Essential tremor most frequently affects the upper body, such as the hands, arms, head, and larynx (which makes the voice more difficult to understand). [27]. Individuals who have survived a stroke present with varying degrees and types of neurologic impairments and functional deficits. Stroke etiology is divided into ischemic (90%) and hemorrhagic (10%). Of ischemic strokes, the thrombotic type is the most common, followed by embolic and lacunar types, respectively. Strokes are further classified by the brain's anatomic blood supply and related neurologic structures. Each stroke has a varied clinical presentation secondary to vascular anomalies and the size and extent of the lesion, as shown in the table 3.1.

Challenges	Solutions
Users may not be able to use the mouse.	Make sure that all functions are available from the keyboard (try tabbing from link to link).
Users may not be able to control the mouse or the keyboard well.	Make sure that your pages are error-tolerant (e.g. ask "are you sure you want to delete this file?"), do not create small links or moving links.
Users may be using voice-activated software.	Voice-activated software can replicate mouse movement, but not as efficiently as it can replicate keyboard functionality, so make sure that all functions are available from the keyboard.
Users may become fatigued when using "puff-and-sip" or similar adaptive technologies.	Provide a method for skipping over long lists of links or other lengthy content.
Tab 3.1: Key Concepts: Motor impairments [27]	

For most traumatic injuries it is crucial to understand that such user groups are not only hindered through physical limitations but also pegged back by psychological trauma. These users have been interacting with kiosk and ATMs with relative ease, to facilitate their regular needs, but it becomes quite a psychological challenge to adapt to the enforced new limitations. Their course of interaction in days and years before the

trauma has created an innate sense of rigidity to adopt new and often more complex HCI technique. Designers of IKs and ATMs for such user groups should try to accommodate these physical and psychological needs to ensure a reasonably sound interaction process. Similarly, users with congenital conditions require more physical support to their interaction but limiting their dependencies on external forces can boost their confidence and reduce the anxiety of HCI.

This research focuses on both the physical and psychological needs of the two types of user groups and tries to gather information on what type of support can be helpful for such disabled users without defining or labeling their disabilities. The research uses well constructed surveys and usability test to gather as much information as possible for developing an alternative design for both categories of disabled users, in such a way that a sense of ownership and respect can be associated with their interaction.

4. Research in ATMs and Public Kiosks

As information systems are becoming more complex and more comprehensive, it is becoming increasingly difficult to create interfaces using discrete buttons and controls. ATMs and information services have grown to the point where they offer so many services that it is not feasible to have discrete buttons to represent each function. Similarly, information kiosks may have as many as 300 different functions or services provided by a single station. Even small cellular phones are gaining new functions (Figure 4.1). To address the interface needs of these systems, designers have increased their reliance on touch screen technologies. These technologies allow the designer to break up the functions of the phone into discrete subsections which can be presented hierarchically on simple screens.



Fig 4.1: Some of the latest Touch Screen Phone available today (From the Right: Apple Iphone 3GS, Samsung Omnia 2 and Nokia N97)

This type of display, however, presents particular access problems for people with visual impairments, blindness, or literacy problems or is disabled, in some way or form. The number and arrangements of "key" changes and there are no tactile cues on the touch panel. Furthermore, tactile cues cannot be added, since the number and arrangement of the "keys" usually varies from screen to screen. Memorization of the location and function of the keys is also not feasible, due to their sheer number.

It is also difficult or impossible to operate by anyone whose eyes are otherwise occupied, as when driving a car. The lack of tactile cues means the user must look at the touch screen to operate it.

The magnitude and significance of this problem is growing rapidly as such systems are being increasingly used in automated transaction machines, government service kiosks, personal electronic telecommunication devices, and even home appliances. In some cases, it is an inconvenience, since other accessible devices currently exist but in other cases, especially public information systems, electronic building directories, automated transaction machines, and government service kiosks, these interfaces are blocking

access. As they appear on car phones, pocket cellular phones, personal digital assistants and other devices which may be used in a car, they may pose significant public hazard, since they require the user to take their eyes off the road for extended periods of time in order to operate them. In this section I highlight some of the research that is being carried out to resolve accessibility issue for the disabled and the visually impaired.

4.1. A Model for Multisensory Interaction

Researchers at Interval Research Corporation developed a framework for designing haptic interfaces in PCMs with maximum integration of interlaced virtual and physical interfaces [3]. According to MacLean haptic interfaces today have just been optimized and converted from regular Interfaces which provide little interaction between the physical and virtual layer of the machines design [3]. She believes a redesign can help in contemporary interaction applications, and offer a holistic view of how to use it [3]. MacLean has also been involved in other haptic interface design like the Haptic Door Knob [4]. Concerned with creating a successful interaction rather than to using haptic feedback, an application designer should take a “top-down” approach, which begins with a need to provide an effective interface to a given application and finds a solution from a suite of technologies and methods.[3]

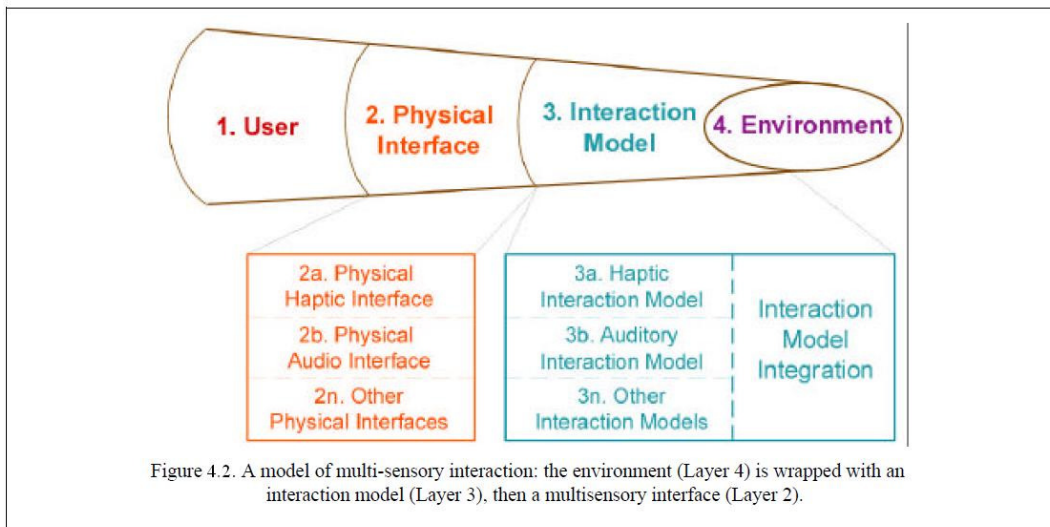

The design (Figure 4.2 [3]) allows an arbitrary relation between user and environments, whether direct or abstract, whereas prior emphasis has dwelt on creating the outer hardware layer, MacLean states “*there is much to be done by creatively disposing the interaction model into abstract forms*”[3]. Using her model she believes we can incorporate a multitude of element in our PCM for example ‘Direct Manipulation’, ‘Discrete and Continuous Control’, ‘Mediating Dynamic System’ ‘Annotations’

‘Container Manipulation’, ‘Displaying Interaction Potential’, ‘Embedding Haptic Interfaces’, ‘Container Manipulation’.

MacLean has also moved a step forward and defined working structure for designing of haptic interfaces, by utilizing her ‘Multisensory Interaction’ principles [40]. She takes into account the special qualities of touch and defines them as tangible and presentable quantities, for which the haptic design must cater to. She elaborates them as ‘Bi-directionality’, ‘Social Loading’, ‘Gestures and Expressions’, ‘Multiple Parameters’, and ‘Resolution & Associability’. MacLean’s design is revolutionary due to the simple fact that it is proactive to touch. Her design clearly maps out a haptic touch trail by defining reasons for touching and mediums of tangibility. MacLean [40] goes as far as suggesting designer to define a haptic language to better understand and remove noise interaction for active touching [40].

4.2. Commercial Research at Immersion Corporation

Immersion Corporation has been the leading haptic device manufacturer for many years and is currently developing haptic technologies for a multitude of devices including kiosks and ATMs [2]. Immersion’s haptic patents address the lack of tactile feedback by designing radical new touch screens which resolve traditional issues like parallax and proximity errors [1]. The company believes that such touch screens will be essential for PCMs of the future and a local estimate by the company states that all mobile phones will use touch screen by 2012 therefore, implementation of the new design is imperative[2].

The company is working on licence contracts with Nokia, Samsung, LG, Medtronic, VW, BMW, Microsoft and Sony. In partnership with 3M touch screen division Immersion is currently working on applications like casino gaming, ATM’s, kiosks and waiter and waitress stations [2]. The company has already received acclaims from Casino Journal for adding haptics to improve the user video experience [2].

4.3. Research at TAUCHI

Researchers at TAUCHI centre at UTA have been working on PCM for several years now. The research group was evolved in a multitude of projects from facilitating haptic environments for visually impaired children to designing multi-modular kiosk with interactive agents. The group has also been involved with mobile haptic research and is developing strategies of defining vibro-tones to assist HCI. [5]

The group has developed an information kiosk for the museums in Tampere (Figure 4.3). The kiosk includes an interactive agent that helps and entertains users as well as provides vital information associated with public kiosk. The group says that their avatars can be modified to depict different behavior sets. These agents can be altered using the computer vision component designed for them [5]



Fig 4.3: The Info Kiosk developed at TAUCHI [5]

A Multimodal User Interface for Public Information Kiosk

Another group at UTA headed by Roope Raisamo has done extensive research on current kiosk design and believes that a multimodal approach is required to move forward. Raisamo [41] believes that limited touch screen interaction may soon be difficult to sustain usability for Public Kiosks, which have an ever growing array of information reservoirs. The research shows that information kiosks are being used as a resident advertisement strategy for services and product awareness, which needs to be accessible to a variety of users. Raisamo believes that previous systems like Digital Smart Kiosk [43] and Cybcérone [44] although may be highly interactive advanced kiosk prototypes but they lack the ability of multimodal interaction, whereas prototypes like the MASK Kiosk[46], DINEX[47] or WebGALAXY[45], which use speech recognition, traditionally fall back on a mouse-keyboard system to validate their speech interface. This in turn limits the fluency of interaction and hinders the design of natural UIs.

To resolve this issue the research group have come up with a seamless “Touch & Speak UI” framework which employs the use of touch screen and speech recognition, however, not in parallel. The group uses a restaurant ordering system to introduce their framework (see Figure 4.4) [41]. The system can be triggered naturally by the displayed “dialog” command keywords or by touching the display itself. The group has also been able to implement partial picture selection using the on board touch screen, as well as providing additional input through speech interaction. They believe such interaction provides a more ergonomic experience for the users.

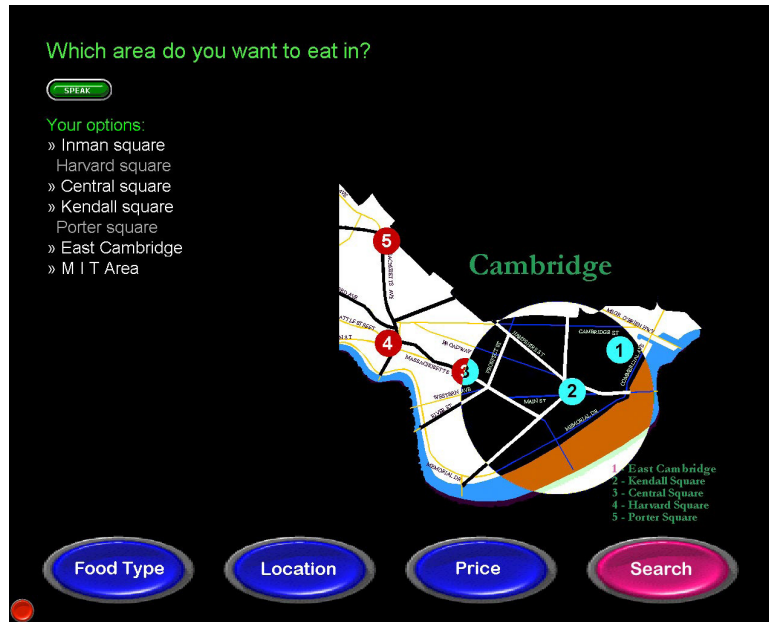

Figure 4.4: A demonstration application is based on the Touch'n'Speak framework, that lets the user select restaurants in Cambridge, Massachusetts [41]

To ensure that their picture selection technique remains error free the group has defined four types of selection techniques. There is also a speech based selection locking system, which lets the user “Lock” and “Unlock” images. Once selection is active, the system is able to use “Time based Selection”, “*EloIntelliTouch touchscreens'* Incremental z-value based selection”, “Nonlinear z-value based selection” and “Direct Selection” techniques to provide fast and naturally fluent user interaction [41] (see Figure 4.5, which shows the HTML page responding to both touch and speech [41]).



Figure 4.5: A resulting HTML page with three applets that respond to both touch and speech. [41]

This research proves that speech based systems can be utilized in public kiosks, which can make them more natural to operate, and thus allowing them to be used by a

multitude of users, including disabled users. The group has also proved that a limited speech engine backed by effective selection techniques may be the way forwards in multimodal interaction of information kiosks

4.4. MATCH Kiosk: A Multimodal Interactive framework for Public Information Kiosk

Researchers at AT&T Research have also designed a multimodal kiosk framework (Figure 4.6). Johnston and Bangalore [42] also remark that kiosks today have become more and more complex, and have the ability to provide even greater a role in information sharing. They believe that their framework provides users with freedom to interact using speech, pen, touch or multimodal inputs. The MATCH Kiosk system responds by generating multimodal presentations that synchronize synthetic speech with a life-like virtual agent and dynamically generated graphics.



Figure 4.6: MATCH Kiosk Hardware which responds to both touch and speech [42].

The system of Johnston and Bangalore [42], builds on the multimodal research of Raisamo, Gustafson and Narayanan [42] which utilizes speech recognition and (Wahlster, 2003; Cassell et al., 2002) who have employed both speech and gesture input (using computer vision) in an interactive kiosk. The windows based MATCH Kiosk system, which is an improvement of the original mobile tablet system (MATCH: Johnston et al., 2001; Johnston et al., 2002; Johnston et al, 2002) responds to the user by generating multimodal presentations which combine spoken output, a life-like graphical talking avatar head, and dynamic graphical displays, as shown in Figure 4.7.

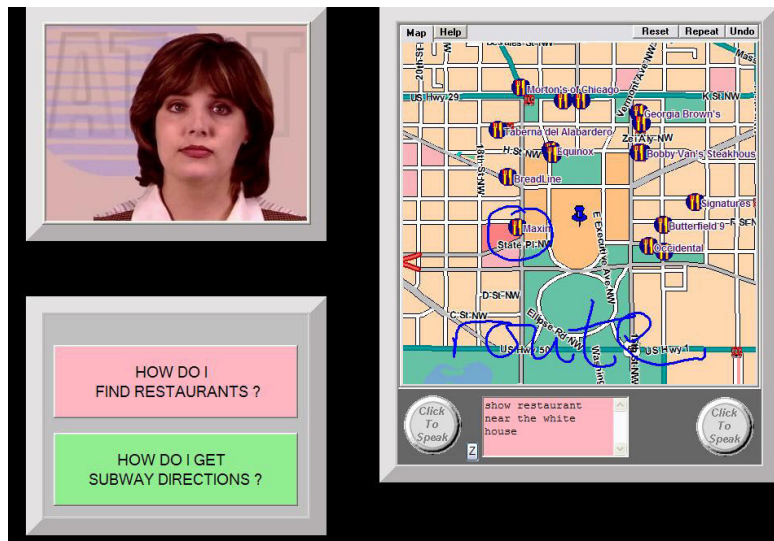

Figure 4.7: MATCH Kiosk Software Interface with Virtual Agent. [42]

The system provides an interactive city guide for New York and Washington D.C, as shown in Figure 4.8. The core functionality of the system is to provide users with information on locating restaurants and other points of interest based on attributes such as price, location, and food type [42]. The system also provides auxiliary information such as phone numbers, addresses, and reviews, and directions on the subway or metro between locations.

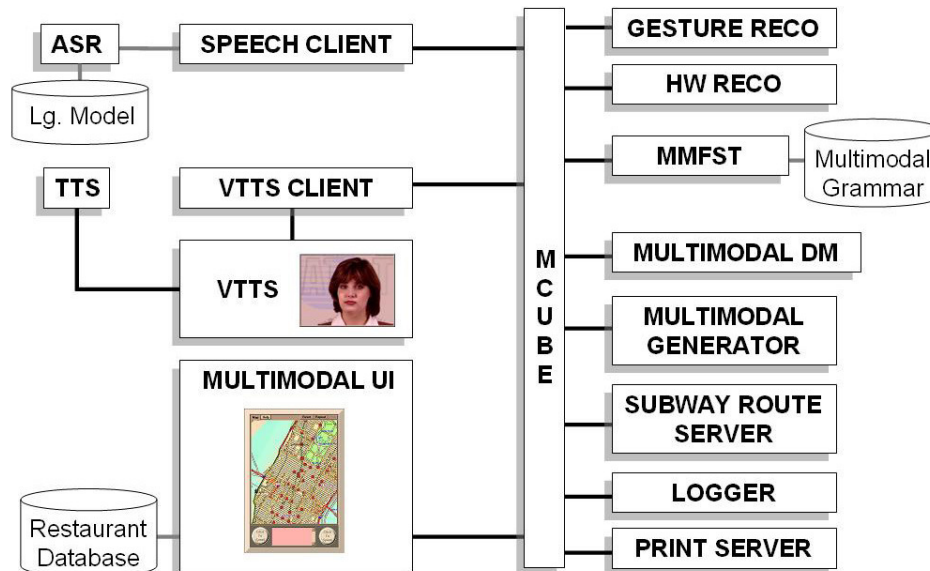

Figure 4.8: MATCH Kiosk Software Interface with Virtual Agent. [42]

In the top left section of the screen (Figure 4.6) there is a *photo-realistic* virtual agent (Cosatto and Graf, 2000), synthesized by concatenating and blending image samples. Below the agent, there is a panel with large buttons which enable easy access to help and common functions, these buttons presented are context sensitive and change over the course of interaction (see Figure 4.6). As the user interacts with the system the map display automatically pans and zooms on the specific locations of restaurants and other points of interest. The system provides graphical callouts with information, and subway route segments. The researcher's claim that the system is robust in nature, working on top of a sound multimodal kiosk architecture, the system employs array microphones for noise resistive input and printing capability to booster its multimodal structure.

4.5. User friendly selection apparatus based on touch screens for visually impaired people

A research group in the US is conducting research on selection apparatus providing user friendly interface for visually impaired people. The group has designed a structure to aid the visually impaired users in usability of touch screens [6]. The researchers claim that by providing a 'guide structure' which is disposed along the touch buttons in the touch screen, and contains touch points corresponding to the touch buttons, can add the critical haptic feedback which may improve the usability of such touch screen for the visually impaired.

The research group states that the specific 'touch points' have been designed in such a way that considerably different sensations are felt when a user slides fingers along the selection structure. An exit may be designed to lead the object from each touch point to corresponding touch button using the T-Bar like structure. Thus, a visually impaired person may slide a finger along the guide structure, feel a touch points and use the associated exit to locate a corresponding touch button. [6]

This research relates to touch screen based selection apparatus used in places such as transaction kiosks (ATM machines), and more specifically to a method and apparatus to make such selection apparatus more user-friendly to visually impaired people [6].

5. Commercial Products

In this section I highlight some of the possible commercial products that are under development and will be available in the near future.

5.1 Audio Feedback Techniques

Audio feedback in PCMs has been frequently discussed as an alternative in effectively providing accessibility to the visually challenges users. World Conference on E-Learning in Corporate, Government, Healthcare, and Higher Education (ELEARN) took a keen interest in provided effective accessibility to the disabled users in their meeting in 2007 [7]. Traditionally it has been very difficult to design a system which is comprehensively able to depict a visual construct in to auditory responses. However, in the last few years we have seen considerable research in the area.

5.1.1 Talking Finger Print

A new technique called the "Talking Fingertip Technique", shown in Figures 5.1-5.5) has been developed which can allow visual access to touch screen-based devices, as well as facilitating access by individuals with literacy, language or other problems which prevent them from reading the text presented on the touch screen. [8] This technique uses hybrid haptic and auditory techniques to allow individuals with non visual access to touch screen systems, even if they have a wide variety of forms and formats. In fact, a prime consideration in the development of the technique was the creation of an interface strategy which did not require the kiosk to touch screen appliance designers to constrain the design of their product in order to incorporate accessibility [8]. The basic elements, principles of the techniques which let visually impaired users access this system are the use of 'Verbal names', 'Screen descriptions', queues for 'Empty space', 'Verbal announcements', 'Text fields announcements', 'Auditory ridge' around objects, 'Separate activation button' to avoid incorrect selections. The research group also has added features like 'Last current choice selection', 'Hierarchical access' as well as 'Edge Hysteresis' which reduces clutter. Specific 'Hot Lists' have also been developed to let the user know that items within the list are actionable, while 'Speedlist feature let the user access global functions with just a press of a button [8].

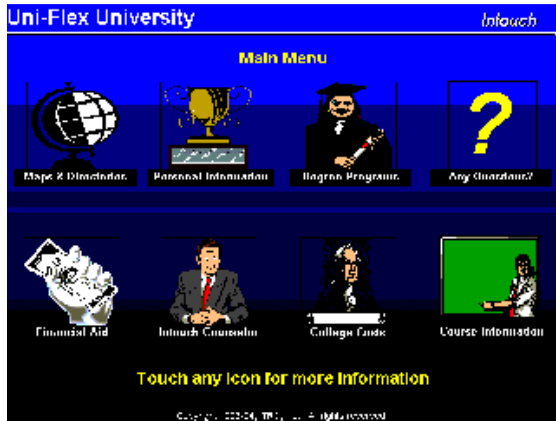

Fig 5.1: The main menu or start-up screen for the kiosk buttons [8].

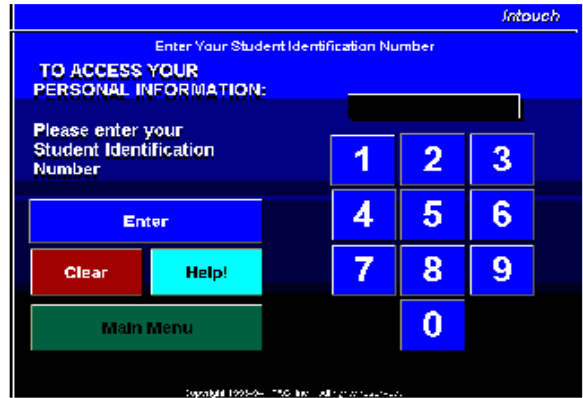

Fig 5.2: A screen with a number pad used to enter the student's ID number and security code. [8]

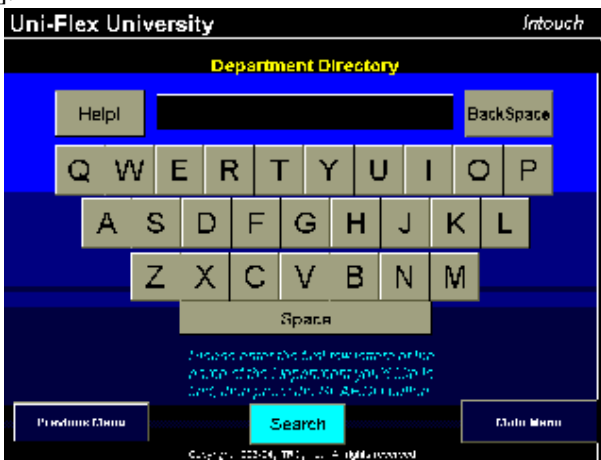

Fig 5.3: An on-screen keyboard arranged in standard QWERTY order [8].

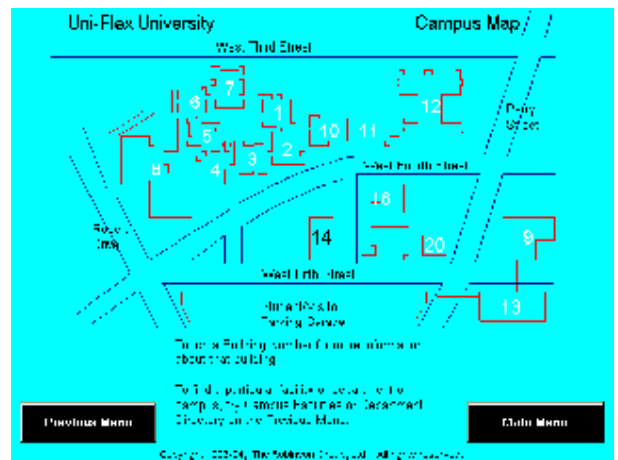

Fig 5.4: A screen showing a map of the campus, where touching the individual buildings brings about information about each building. [8].

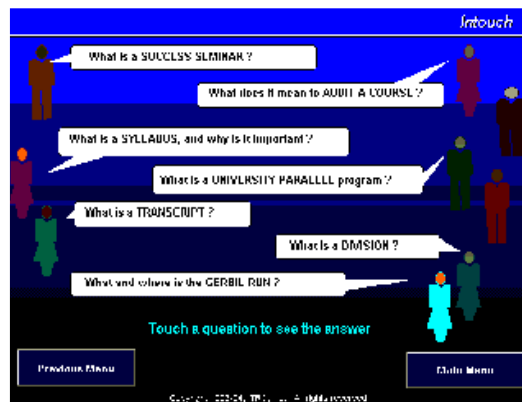

Fig 5.5: FAQ Screens where the "buttons" are represented by graphic devices which are randomly arranged on the screen for esthetic effect. [8]

The prototype has been used by over 100 individuals with low vision or blindness. [8] Since a primary interest in the initial design was the ability of novice users to access and use it, the prototype was taken to five major disability conferences, including three

on blindness, in order to get a large number of individuals unfamiliar with the design. In addition to providing a very rich environment for people to try the device, the conference environment also provided a somewhat noisier environment, more akin to that which would be encountered in actual public settings, providing considerable results with limited problematic issues like nonspacial access, or different selection techniques and difference in searching behaviors between visually challenged and motor disabled users [8].

5.1.2 ‘I Am Hearer’

Another alternative is EZ access technique “Talking Touch and Confirm”, which works similar to the earlier system designed by the same researchers [9]. Touching items on a screen causes the corresponding option to be read out. Acoustic cues are given to guide the individual in exploring the screen. To actually activate (select) the item, the user merely needs to press a pre-specified button.

The difference in this technique is that the authors claim to utilize information as list items instead of normal UI structures, which the authors claim comparatively less challenging and hence cheaper as compared to their previous work (The Talking Finger Print Technique). This alternative technique referred to as “List Mode”, a solid reference/anchor point (the edge of the screen) is provided which users can use to guide their motion [9]. By moving their fingers up and down the edge of the screen, the users can find all of the information and action items. The list mode approach may be complemented with the Talking Touch and Confirm approach noted above to enable selection of a desired choice [9]. The researchers believe that the implementation of the edge may add substantially to the overall cost as sensors may need to be present in the edge to sense the movement of fingers/objects [9].

5.2. Haptics and Security

5.2.1 Haptic-based Graphical Password

This application has been developed using the Reachin system and its API, which captures raw data. The haptic software applications are developed in a combination VRML-based scene and the Python scripting language [10]. Using the VRML nodes, the developers have created the virtual environment; the Python scripting language provides the procedural method to handle programmed events, similar to popular VRML Virtual Reality Systems [10, 11]. The grid is placed on an elastic membrane providing force feedback resistance and friction when the pen’s end-effector of the Phantom Desktop makes contact with the virtual grid object [10, 11]. The researchers have are currently using the Phantom device to register the pressure exerted at each

node while in the future pressure pens can be used to replicate the forces exerted. An implementation of both 5 by 5 (5x5) and 8-by-8 (8x8) grids, in comparison with each other are illustrated in Figure 5.6 a and b, to validate the ‘Size’ VS ‘Security’ issues.

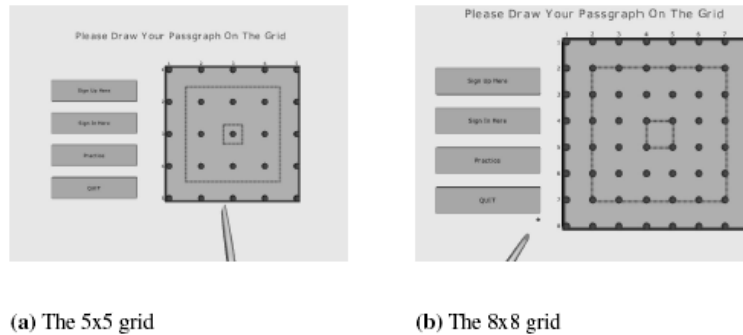

Fig 5.6 The possible length of a GHP [10, 11]

Using the scheme, users can connect any two points on the grid selectively, so that it increases the size of possible passwords. In order to protect against shoulder-surfing attacks, the user has to vary the pressure of the input device as the additional component of choosing a password [11]. Therefore, the user’s password will be a combination of coordinates and the pressure of the input device, which is recorded as a binary input. The added binary pressure increases the possible password’s space more and yields, as a secure online public password scheme [10]. Figure 5.7 shows the password that the user may choose in such a scheme. The bold lines in Figure 5.7 indicate places where the user has put more pressure in drawing.

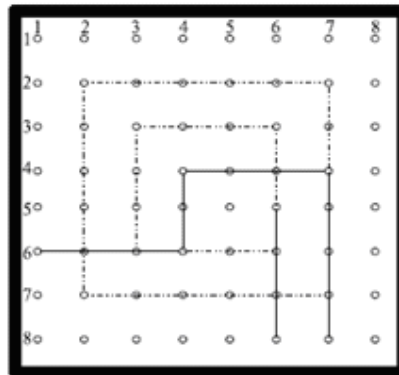

Fig 5.7 Actual view of a GHP on the screen [11]

The information captured in Figure 5.7, is a tuple $(x;y; p)$, where x and y represents the position of the selected points on the horizontal and vertical axis, respectively, and p is a binary input indicating if high (more than the user’s average) pressure is exerted when two points on the grid are connected [10,11]. The tuple $(j;1;j;1)$ is recorded when a pen-up happens. For example, the data recorded from Figure 5.7 are listed as follows:

(1;6;0); (2;6;0); (3;6;0); (4;6;0); (4;5;0); (4;4;0); (5;4;1); (6;4;1); (7;4;1); (7;5;0); (7;6;0); (7;7;0); (7;8;0); (j 1; j 1; j 1); (6;6;0); (6;7;1); (6;8;1); (j 1; j 1; j 1):

The length of a Graphical Haptics Password (GHP) as the number of tuples or rows representing the password including the number of pen-ups; for example, the length of the GHP given above as 17 and the last pen-up has no information (Figure 5.7).

5.2.2 New Siemens Internet Haptic ID Card

Hackers obtain a wealth of account details using phishing websites, and they caused damage amounting to at least €14 million in Germany last year [12]. The bank card-sized Internet ID card (Figure 5.8) from Siemens IT Solutions and Services and Swiss company AXSionics is designed to reduce if not completely eradicate such security threats. The ID card is equipped with a fingerprint scanner and six optical sensors. Initially, the user identifies himself using their fingerprint. The bank's website then sends a flicker code, which the sensors of the ID card registers and decrypts. In the process, the monitor displays six rapidly flashing fields that alternate between black and white.



Fig 5.8: The Fingerprint flicker code decoder

The flicker code contains the details of the funds transfer previously submitted to the bank and the associated transaction number (TAN). Using an integrated cryptographic key, the ID card decrypts the code and displays the deciphered information on its small screen. The user makes sure the transaction data is complete and finally confirms the transfer by entering the TAN currently displayed [12]. The manufacturer claims that neither software nor hardware is required for the Internet ID card, which they say would mean the Internet user can safely conduct banking business worldwide without a separate TAN list [12]. However, such a system has not been tested on a large scale and, therefore, the manufacturers claim of usability and security are yet to be confirmed.

5.2.3 Mobile Kiosk Access

In Nagasaki, Japan, commuters can use their mobile phones to pay for their bus rides [13]. They also use the phone to get cash from an ATM, make credit-card purchases or for basic personal identification. Therefore, the phone represents an electronic wireless ID card which may be used for a multitude of verification and validations. It has all been made possible by the F900iC built by Fujitsu for NTT DoCoMo's FOMA W-CDMA network [13, 14]. It is the first of its kind but is expected to lead the way for other manufacturers in NFC [15].

The F900iC uses contactless smart-card technology called FeliCa developed by Sony, as well as a fingerprint reader that authenticates the user and unlocks the handset [13]. The phone, which went on sale in early August 2004, uses the Symbian operating system, has a 1.28-megapixel camera and removable memory. Fingerprint recognition, often using haptics technology, and contactless smart cards are seen as key enablers for the advancement of m-commerce [13, 14]. Combined, the two technologies provide the security and ease-of-use necessary to expand the market.

Immersion Corporation and Atrua Technologies are working with handset manufacturers to put their fingerprint technology into cell phones [2, 13, 14]. As the latest effort to unite the two companies on January 9, 2009, Immersion Corporation consolidated its Touch Interface Product, Gaming and Mobility business units into one business unit referred to as the Touch Line of Business. In connection with the consolidation, the Company appointed G. Craig Vachon as Senior Vice President and General Manager of the Company's Touch Line of Business (owned by Atrua Technologies). The new division is tasked with the design on multiple mobile haptic projects due to be release in 2010 [48].

Immersion's profitable relationship with Samsung, which has yielded the infamous SCH-W559 [51], is set to continue to produce mass market products in 2010 as well. In fact, Stuart Robinson, director of the Handset Component Technologies service at global research and consulting firm Strategy Analytics, was quoted as saying that by 2012 as many as 40% of mobile phones could be using some form of touch sensitive technology, which mean Immersion's relationship with mobile manufacturers with increase in the next couple of years [49, 50, 51].

5.3. Electronic Voter Kiosks (for the Disabled)

There are 750 million to 1 billion people with disabilities worldwide [16]. Of the estimated 55 million people in the United States with disabilities, 73% are heads of

households, 58% own homes and 48% are principal shoppers controlling over \$220 billion in discretionary income, reported by Census Bureau and Solutions Marketing Group [16] There as 55 million disabled in the US, of which 29.8% have mobility limitations 24.8% have limited hand use, while 11.9% have vision impairments [16]. Considering the figures it is imperative for PCM designers and manufacturers to accommodate these large user groups by simplicity of design. Some firms are trying to accommodate this user group by providing special interaction like wheel chair access, large keys structure and visual and auditory queues on specific selection areas. One such firm is Opti-Wall Kiosk, who claims that their system improves access for the disabled by providing a range of special interaction techniques [17]. New legislation, such as the State of California Civil Code 54.9 which now requires hotels and public transportation facilities to make touch-screen devices accessible by 2009 for people who are blind or who have low vision may soon provide a powerful impetus for the retail industry to ensure that point-of-sale kiosks are accessible as well [16].

Efforts have also been made in designing voter kiosks for the disabled to increase usability for the disabled. Audio and haptic feedback plays a crucial role and relaying visual information. ESS Ballot Box by Quad Media in the US (Figure 5.9 a) uses the same principals of auditory representation to depict visual information successfully [18]. Australian Government in corporation with the Australian Electoral Commission (AEC) also started trials on a project for electronic voting for the vision impaired (Figure 5.9 b) and military personnel [19]. And now more and more kiosk manufacturers (like Envoy Kiosks [20]) have added such features to promote the use of their kiosk by disabled user (Figure 5.9 c).



Fig 5.9a: The ESS
Ballot box [18]



Fig 5.9b” The (AEC)
Electronic Voting device
[19]



Fig 5.9c: Envoy Secure Access Kiosk [20]

5.4 Public Haptic Kiosks

5.4.1 VFIT Kiosks

A privately funded company FormaLogix has developed a virtual shoe size generator known as the VFit Kiosk (Figure 5.10). The VFit kiosk uses digital imagers to capture a three dimensional image of the user's feet and compares that to an exact 3D form of the inside of a specific shoe [21]. FormaLogix VFit technology is able to determine exactly what size a person wears in a particular shoe style and brand without the person ever trying on the shoe. The company claims this technology will help the retailers, improve customer service, validate fit, size, and ultimately reduces the number of returns resulting from poor fit. When a person uses a VFit kiosk, she/he are prompted by an interactive video that takes them through the entire scanning process [21]. They are asked to make several selections as well as enter their email address and shoe selection, using a touch screen display that provides haptic feedback.

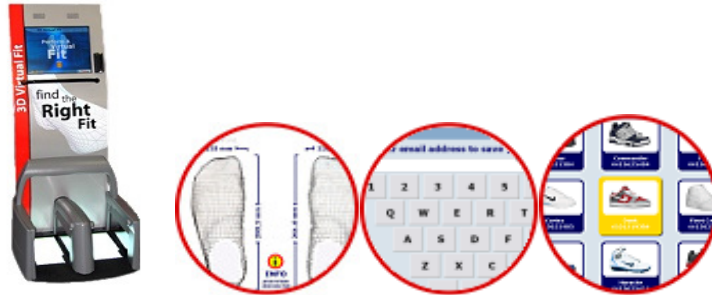

Fig 5.10: VFit kiosk and the three steps involved in determining shoe size [21]

StacoSwitch the company which has decided to implement VFit technology, is trying to eliminate the frustration and confusion that comes with using touch screens by introducing their Tactile Feedback Touch screen to interactive kiosks such as the VFit Kiosk. StacoSwitch's touch screen system uses haptics technology to create the perception of touching physical buttons or switches. Tactile feedback is integrated into the touch screen interface by the use of actuators and controllers. Combining individual effects of varying frequency, waveform, magnitude and duration of an actuator's output make the touch screen come alive in response to user contact. The company claims this technology will soon be available to most retailers [21].

5.4.2 Diebold - Vectra

The Vectra Concept Terminal is an award-winning (2005 Industrial Design Excellence Awards) [22], conceptual ATM machine that was the first in the world to use haptic technology [22]. The ATM has a single entry haptic rotatory dial similar to the technology found in certain luxury automobiles which eliminates the need for multiple buttons and knobs (like the I-drive in BMW[25], Figure 5.11). The company believes

that this technology provides many benefits to the user which includes a single point-of-entry for data, and consequently, a much higher level of security [22].



Fig 5.11: Vectra ATM [22]

The Vectra can be used to facilitate disabled users by providing haptic responses to input sequences (figure 5.11); however, the company has yet to focus of the said target groups. While the implement the technology on large scale has also been rather restricted, considering the first machine was unveiled in 2004.

5.4.3 Health Information Portal (HIP)

EMIS and PAERS have jointly created a Health Information Portal for patients HIP [23]. The research groups claim that this portal provides a safe and controlled environment for patients to view their medical records, browse extensive health information and complete practice questionnaires [23].

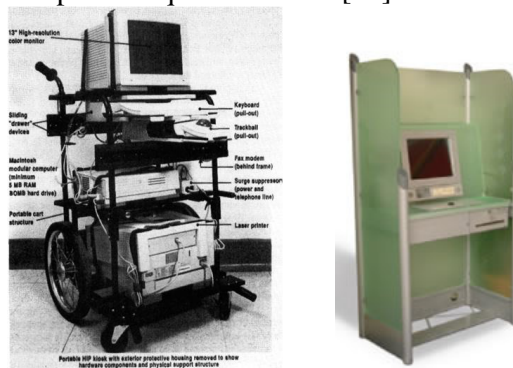

Fig 5.12: HIP Kiosk as design and PCM [23]

HIP is said to be available to all practices using EMIS LV and PCS clinical systems. Researchers say that the practice-based kiosk provides patients with greater access to their medical history and the opportunity to learn more about conditions, treatments and medication - free of charge considering they wait for their appointment (Figure 5.12). Research by the groups has shown that patients feel having access to their medical records improves trust, understanding of their illness and the doctor-patient relationship [23].

HIP kiosks are also available with an integrated printer to allow patients to print and take away information. Unique fingerprint authentication offers a secure, reliable and accurate method for patient identification while the polarized screen ensures privacy, as only the patient sat directly in front of the kiosk can view the information shown on-screen [23].

Computing and machines will keep getting more versatile, powerful and complex. This trend will open the door to a new level of haptic interactivity between humans and computers, which intern will provide, previously forgotten disabled users more accessible interaction devices and interfaces than ever before. The current research seems as a prominent step in promoting 'Haptic Computing', which has now gained momentum in a variety of computing devices, especially in the mobile sector.

Some of the research and devices highlighted in this section prove researchers claim of haptics, being the new evolutionary step in mass computing. Perhaps the most effective way of introducing haptic devices is through PCMs which can act as an ease through barrier for the technology to be accepted in the masses, especially the disabled. As more and more devices and interfaces make it into production there might even come a day when disabilities of any kind may not play any role in computing ability of an individual.

6. Requirement Research for PCM Design for the Disabled

The basic purpose of the research in this thesis is to come up with a design structure which can decrease accessibility concerns for the motor and visually impaired users and increase the usability to such an extent where the target user groups enjoy similar interaction as users without any such disabilities.

6.1. Research Guidelines and Market Trends

Usability research in the field, points to the need to come up with a multimodal approach in resolving the situation, as highlighted in Chapters 4 and 5. Research has been conducted at multiple fronts and many frameworks have also been put forward as well, but unfortunately, a uniform crystalline implementation strategy of these frameworks has yet to yield concrete designs. Multinational Corporation, recognizing the market benefits has also stepped forward in facilitating the needs for such designs. Diebold, has been working to develop ATM machines for the visually disabled since 2002 [22]. Even after the phenomenal success of their 2005 model, the company has taken a step back and consolidating their position. Current market trends and the world economic situation, has played a vital role in the slowing of many research projects, around the world.

Although some of the concerns in usability research may be the current financial crisis one of the main issues which have still not been resolved is the designing of radical new processes for the development of Hardware and software for the users with visual limitations. Currently all efforts are directed to the developing or masking of the current systems with an overlay of components that can provide the specific target user with some form of accessibility to the system. MacLean, previously a researcher at Interval Research Corporation, believes haptic interfaces today have just been optimized and converted from regular interfaces which provide little or no interaction between the physical and virtual layer of the machines design.[3] MacLean believes a redesign can help in contemporary interaction applications, and offer a holistic view of how to use it. According to the design of most of the currently available systems it seems that MacLean does have a valid point when she points out the fact that there is no seamless integration between the Physical Components and the Virtual Design Layer of such systems, hence the result are laborious and ineffective designs with low usability and control.

According to a growing number of researchers like MacLean, now a professor at UBC, Canada, designers of systems for the visually challenged need to adopt a bottom-top approach in designing and implementing the designs of Systems which are targeted for

the specific User groups. In my opinion, it is only when this is done a true representation of the product can be embodied into a usability framework and natural and ergonomic designs can be generated which are explicitly designed for the target group instead of being modifying or mimicking the functionality or usability of the specific users. In this spirit for this thesis, it was imperative to deconstruct the current accessibility and usability issues of the current PCM especially the ATMs. For this purpose the initial objective of the research was to collect as much information about these issues as possible.

6.2. Target Audience and Requirement Elicitation Process

Whenever we talk about disabled users of any computing devices we always have the two basics types of disabilities that greatly hinder use of computing devices, users with limited or no visual abilities, and users with limited or no motor abilities (see Chapter 4). There has been a lot of research on how to design and construct systems for visually challenged users, where as users with limited motor abilities have been somewhat ignored. Therefore, it was decided to focus the research to the fundamental disabilities visual and motor limitations. In this research, I highlight the effects of ATM usage for users with diminished motor abilities and some of the new assistive technologies that can be used to help the HCI process.

This research focuses on both the physical and psychological needs of the two types of user groups and tries to gather information on what type of support can be helpful for such disabled users without defining or labeling their disabilities. The research uses well constructed surveys and usability test to gather as much information as possible for developing an alternative design for both categories of disabled users, in such a way that a sense of ownership and respect can be associated with their interaction.

6.3. Surveys and Data Collection

I decided that three independent studies would be conducted to gather all accessibility and usability issues. To ensure that only the required issues were highlighted, the initial survey was done on a broader target audience [Annex C] so that the second string of surveys can be mapped with these results which would ensure a true sample representation be extracted from there surveys. Users from the age of 22 to 65 were asked to fill out an online questionnaire after their use of their local ATM machines. These anonymous questionnaire/forms were hosted online and thus a multitude of users where asked to try to give their feedback. Hence a total of 387 participants, from from countries (Germany, USA, Russia, Pakistan and Finland) took part in the initial survey

with 37% of the users were over the age 35, while 28% were over the age 50 and 19% were in our category of disabled users (with either some motor or visual disability).

6.4. Results and Analysis

Resolving the results it was found that an overwhelming 91% of the users under the age of 35 prefer ATM transactions compared to the any other mode of transaction, while users over the age of 45 had no such preference and use bank tellers as well as ATMs. However, out of the 72 disabled users most 73% preferred to use the ATMs with the help of their partner, friend or family member; however, the willingness to reduce this handicap was over whelming. There were also 17% of the users who found the use of ATM to be difficult or impossible and preferred to approach the bank tellers for their financial needs. These user primarily include most visually impaired users

Some suggestions were also presented during this survey to increase the reliance of ATMs, for people over the age 45; as well and disabled users. Considering no suggestions were asked, this feedback points to the fact that the suggested target audience feel there is a need to address their concerns. Consolidating these suggestion four points for each target group, became obvious from this phase of surveys, which are as below [Original Questionnaire with results as attached as Annex B].

Users over 45 complain about the following matters:

- Too much technical or financial jargons,
- The process is not very ergonomic (physical & mental strain)
- Difficulty in using hardware or software
- No customizability of hardware or software to ease the process.

Users with disabilities complain about the following matters:

- No alternatives in use of ATMs for special users
- Designs predominantly favouring mass users (limited or no usability standards for special users)
- Lack of consideration for physical space accessibility
- Limited modes of communication (modalities of communication).

Once the initial survey results were analyzed it was clear that the target audience had considerable issues with current PCMs and ATMs in particular. The use of ATMs by this user group will reduce considerably if their needs were not realized. Using the current issues collected for the first survey, a more specific survey/questionnaire form was created for the target audience at local Tampere ATMs. Identifying the disabled

users onsite, and asking them to fill out the questionnaire proved considerably difficult, due to the reserve nature of the local Tampere population, however, 23 users participated in this phase of the survey, and 10 of these users were also interviewed on site to understand their emotional concerns.

Most users reiterated the results from the previous survey, highlighting concerns primarily related to the fact that there are no handicapped ATM booths, while concerns over the physical location of the ATMs, their physical accessibility, and was also a disheartening fact. Wheelchair users voiced their concerns with respect the fact that almost all ATMs, at least in the Tampere area are wall mounted and hence perpendicular to the ground, with little or no leg room for wheel chair users, hence all such users are forced to operate the ATMs sideways, with quite poor visibility. Even so, the angle of most ATM displays is unsuitable for effective visibility. Even if these issues were catered to, one of the basic reasons for aided ATM use, is the simple fact that the insertion of the bank/ATM card is impossible for wheelchair users, who cannot reach to designated height. Furthermore, these users also complained about the visual access to the key pad and selection keys.

Users with limited or no visual capabilities have similar issues related to usability. Issues related to the insertion of ATM card, and being able to locate the right number keys to enter their pin codes and the selection keys, to input a selection. The lack of any haptic and/or audio assistance for these users has caused a simple ATM transaction into a daunting challenge. Unlike wheelchair users, this user group usually requires external assistance throughout the transaction process; hence they are forced to share critical financial information with their guiding persons.

The third user group, interviewed throughout the research, was users with finger/hand or arm motor impairments, which cause jerky and uncontrollable movement of their limbs. These users have considerable problems with, using touch screens, and narrow selection buttons, because of their medical condition. Such users provided feedback to the fact that there was limited or no arm/elbow support for them at the ATMs, which increase the risk of muscle spasm during transaction selections. Hence, more often than not wrong selection are made, causing anxiety and frustrations, compounded by the humiliation of repeating a simple transaction multiple times to get the desired result.

An addition to temperature difference can be allotted to the entry and retrieval areas on the ATM, this would mean that the area of placement of example ATM Cards/ debit Cards can be kept cooler than the surrounding temperatures to provided assistance for

visually impaired users, similarly the cash access area can be kept warmer for easy identification.

7. Hardware and Software Improvement Proposals

The research's main aim was to specifically identify the concerns of the disabled users and to design a prototype that can remove them. For this purpose the study that was carried out to isolate the prime obstacles that may exist for the user group. The study shows that an overwhelming 91% of the users under the age of 35 prefer ATM transactions however, out of the 72 disabled users only 73% preferred to use the ATMs, if the help of their partner, friend or family member was available. Amongst the disabled a disturbingly large 17% of the users found the use of ATM to be difficult or impossible and preferred to approach the bank tellers for their financial needs (see Section 6.4). It was noted during the survey that disabled users complained about use of too many technical or financial jargons, the unnatural interaction process (putting physical and mental strain) and the lack of assistive or alternatives hardware for them.

Multiple element of ATM design has come under study, and debate. Some of the issues raised can be resolved by simple alterations of physical structure of ATM while some of the issues require additional hardware or software to provide the necessary results. In this section an effort has been made to remove such issues that hinder accessibility for the target audience, with simple location and structure alteration proposals.

Alteration Proposals:

- Providing Wheel Chair Accessibility

Most disabled users make use of assistive equipment for navigation and transportation like walkers, walking sticks, motorized carriages and wheelchairs [16]. However, in most ATMs and public kiosk, there is no additional legroom to accommodate users with such aids, as shown in Figure 7.1, and users either end up with severe usability disadvantages, or complete accessibility constraint [17]. The results of this study show that users with wheelchairs cannot access ATMs and public kiosk without external assistance. Therefore, most disabled users with wheelchairs have limited or no ATM access preferences [20, 27].



Fig 7.1: Wheel Chair Access

- Adjustable Displays

ATMs and Information Kiosks are usually designed for specific height access. Users are required to be at a certain angle and distance to the display, in order to access the machines. Unfortunately all users may not be able to fulfill this design criterion as seen in Figure 7.2, and due to the limited angle of viewing in most ATMs and public kiosk display units, it often becomes a major usability and accessibility issue for most disabled users, with wheelchairs and height disadvantages.



Fig 7.2: Adjustable Display

However simple alterations to the vertical display unite can easily remove a majority of issues faced by disabled users [52], thereby increasing their usability to an array of kiosk and ATMs. This can easily be done by adding a 20 degree vertical adjustment to the main display unit [17, 22].

- Ergonomic design to reduce excessive hand movement

Touch screens used in ATMs and information kiosks are primarily designed to display information using explicit visual cues that depends greatly on the visual modality [41, 43]. Considering the display unit doubles as the primary and in some cases only input device, input usability is often limited or even overlooked. The target audiences, with motor impairment suffer from wobbly and jerky hand movements, (as explained in Chapter 3). Hence their disabilities, not being catered for during design of these kiosks, put the disabled users at great disadvantage in being able to control and manipulate the UI to ensure effective and error free usage.

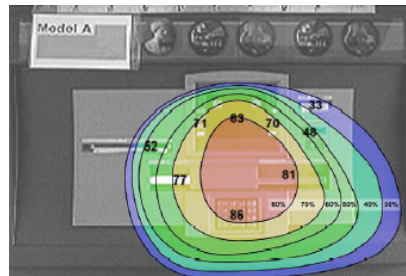

Fig 7.3: Ergonomic Design

To avoid these users from limited access to the system through touch screens, the software design for kiosk should cater to the basic principles of access and usage. The UI can be designed to provide main usability with limited hand and forearm movements during single data selection cycle thereby providing ergonomic designs to reduce excessive hand movement in single use cycle, as shown in Figure 7.3, and thus encouraging motor impaired users

- Visual and pictorial representations

During the study participants attributed limited usability greatly to the language of the UI [22, 27]. Most elder as well as disabled users have limited understanding of financial and technical jargons, or have limited attention spans. Therefore, these users have limited knowledge of the entire functionality of the UI and rely mainly on either heretic or presumptuous selections. and hence to avoid putting these users through laborious navigation of the kiosk UI, simple images can be provided along with pictorial abstracts (as seen in Figure 7.4) to convey technical or financial lingo for inexperienced ATM users.



Fig 7.4: Pictorial Representation of the legal and technical jargons

- Use of Additional Modalities

Current design of most kiosks and ATMs rely heavily on a single modality for interaction, which puts users with disabilities at a considerable disadvantage. Studies by Raisamo [41], Johnston and Bangalore [42], Christian and Avery [43] and others provide overwhelming evidences that a multimodal interaction approach provides more usability to a greater scope of users as compare to the single modality approach. Therefore users with disabilities may benefit greatly if kiosk and ATMs could use “audio” along with visual modality. A simple retractable headphone wire can be coiled in the keypad for extension, by used who wish to increase their usability through an added interaction medium, as shown in Figure 7.5.

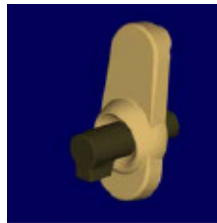

Fig 7.5: Use of Ear Phones

In addition to ‘audio’, ‘temperature’ difference can be allotted to the entry and retrieval areas on the ATM, this would mean that the area of placement of example ATM Cards/ debit Cards can be kept cooler than the surrounding temperatures to provided assistance for visually impaired users, similarly the cash access area can be kept warmer for easy identification. Users with limited or no visual ability can profit greatly by such haptic interaction. Therefore with simple alterations to basic components of the kiosk, most of the user-concerns highlighted in the study can be addressed quite effectively, however some concerns require more fundamental changes in design as suggested in Chapter 8.

8. Redesign of Hardware Structure

8.1. Redesign Motivation

For the visually limited and motor impaired users interaction with PCMs has become even more of an issue in accessing IKs and ATMs. There usability concerns have morphed into accessibility issues which limit them from accessing such machine. This issue has not been actively pursued due to the basic fact that such disabled users constitute a very tiny percentage of the users groups and IKs and ATMs are traditionally commercial products targeted for the masses. However, in the last 5 year a considerable amount of research, both in the public and private sectors has been carried out to bridge the usability gap between the different type of users of the IKs and ATMs, including the visually and motor impaired users.

This research has tried to specifically identify the concerns of the disabled users and to design a prototype that can remove them, and from the results of the study its is evident that a prototype design needs to be constructed to remove most of the concern voices by the disabled used (see Section 6.4). Using the results from the study it was decided to construct an implementable design, which could cater to the special needs of the target users groups. For this purpose using a multimodal architecture, prototype hardware was designed. To ensure it was variable, a limited usability test was conducted. Although the test was not extensive in nature, it does prove that, the current system needs to be altered, and that a multimodal approach, with haptic interaction is the way to go for the future.

8.2. Core Hardware Structure

To answer to the explicit needs for disabled users the following design has been put forward. The design consists of a single haptic surface, which can be extended only for the required user groups (this can be determined by embedded information in the ATM Cards).

The surface could be concealed under the number keypad of most ATMs today as shown in Figure 8.1. The height of the surface is ideal for all disabled user groups as well as minimum motor activity is used in its operation.



Fig 8.1: ATM Display

The device target user groups are motor impaired users with limited hand and finger movements, motor impaired users with limited or jerky arm movements as well as visually impaired users with limited or no visual capabilities. For each user group the hardware can dynamically adapt to the requirement of the user. As specified earlier the user groups can be identified via the embedded IDs in the ATM card being used.

The device, as shown in a rough Figure 8.2 consists of three sections. The first section of the device will act as an on board display which may guide in the use of the panel at different time and modes. The panel itself will be fitted with OLEDs which will also light up areas with activated functionality on the panel, as well.

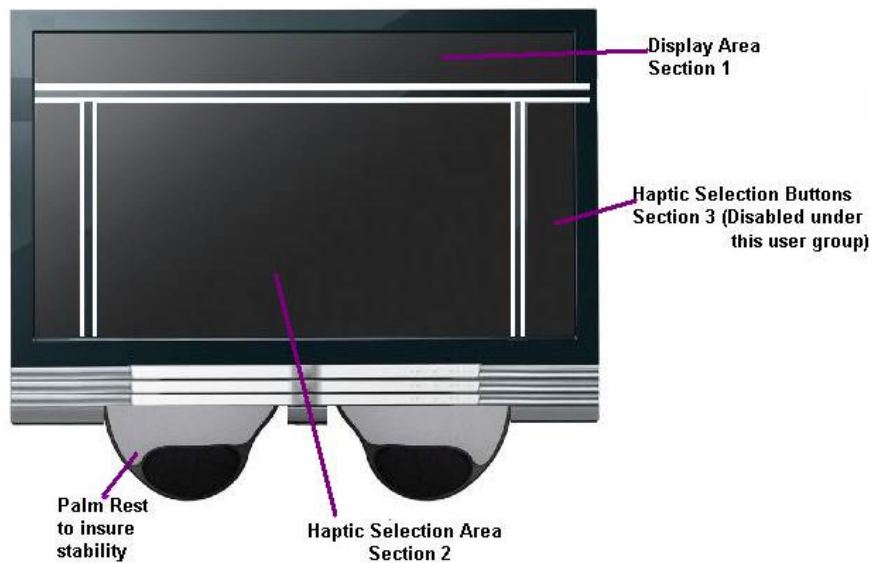

Fig 8.2: Shows a Top view of the Haptic Device in standby mode

The third section is combination of the two-side bar on both sides of the panels. These will act as normal haptic selection buttons that are provided on either sides of a traditional ATM machine, for the third user group (the visually impaired). However, the position and the number of the buttons will be created according to the requirements of the user's programmes, i.e, the Braille selections in section two.

The second section of the device will be able to alter functionality according to the different user groups. This part of the device will provide haptic Braille display for the visually impaired groups, however, the same section of the device will double as a number keypad and selection panel for the motor impaired user groups (as shown in Figures 8.3 and 8.4 respectively)

8.2.1. Braille functions

The legibility of virtual Braille will be observed by using standard haptic Braille codecs. Braille readers are usually able to identify Braille strings composed of letters of the alphabet encoded according to the 6-dot Braille code (as shown in Figure 8.3). According to these codes the users will be provided with a summarized form of selections in section 2 and corresponding selection buttons in section 3, all haptically created at run time, as shown in Figure 8.4.

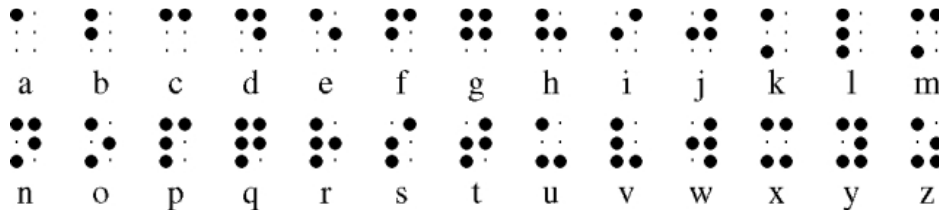

Fig 8.3: Braille code for the alphabet.

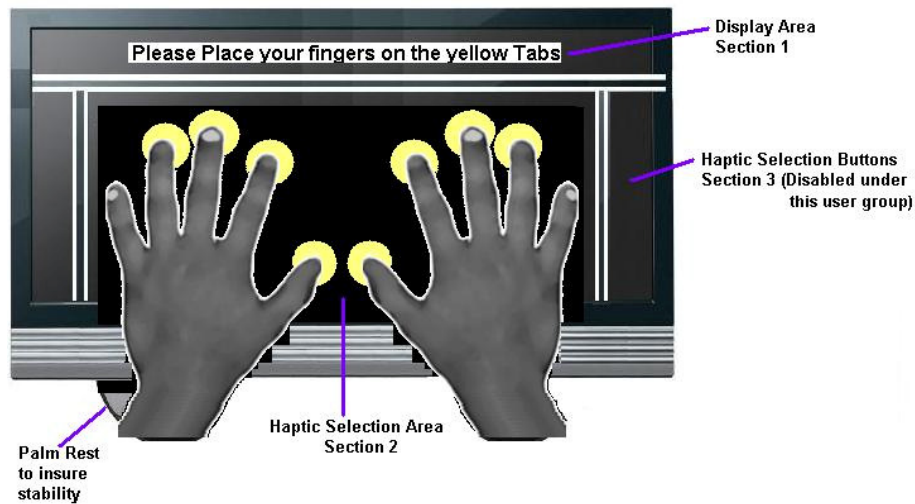

Fig 8.4: Haptic Selection using Section 2

8.2.2. Selection Panel functions

Along with being a Braille display, section 2 will double as a selection panel for motor impaired users. For this user group section 3 will be disabled and all of the functionality would be accessed through section 2. Primarily once the ATM / Debit Card is inserted and the target group is identified the 'Haptic Surface' will be extended from its housing (shown in figure 8.1, 8.2). Section 1 of the haptic device will provide instructions for the next task to the user while section 2 will dynamically adapt to the user group and provide a 'Haptic Number keypad'. Once the pin code is entered correctly section 2 will display the eight 'Haptic Selection buttons', with LED display to facilitate hand positioning (as seen in Figure 8.4). Instructions will also be updated in section 1 to ensure the user understands.

As is visible from Figure 9.4, the motor impaired user is asked to place their hand onto the device. Firstly the palm rest will provide a stable jerk free position for the user to activate selection of any of the four primary selection option (in most traditional ATMs). The yellow circles have haptic buttons that provide tactile and force feedback to assist with the selection process.

8.2.3. Haptic Selection buttons

As discussed earlier during the research it was seen that motor impaired users also suffer from impulsive finger movements, which usually amount to multiple error selection. These error selections are usually of two types. Firstly the user may press two selection button where as the requirement was for one, more common in using the middle and ring finger of both hands, and also the users may move the wrong finger due to motor deficiencies (also common for the middle and ring finger).

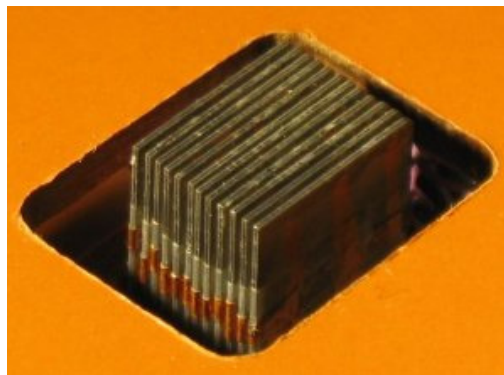

Fig 8.5: Possible structure of the haptic selection buttons

To cater to this problem two techniques can be used, 'First Press' and 'Full Press'. The selection buttons for motor impaired users have been designed to reduce error selections and provide a more fluent experience. To accomplish this, the buttons are a combination of multiple pins like extensions from the surface, as seen in Figure 8.5. Each pin press is monitored by the system and calculation of the number of pins pressed can be easily made. Using this calculation its can be determined in detail of which button was pressed first (if two buttons are pressed) or which of the two buttons were pressed completely (more pins of the buttons where pressed) and hence determine an estimate of the intended selection. Another errors prevention technique is to use the two thumbs in Unisom to confirm an important selection, although this would increase the number of key presses for simple tasks, but as observed the use of the thumb is usually unrestricted even in severe motor impairment, hence provide error free selection.

8.3. Implementation of Haptic Selection Buttons

At the time of design evaluation, it was suggested that the current design, although unique as a whole, was essentially a collection of currently available and functioning technologies, being incorporated to effectively empower the disabled target user. However, the 'Haptic Selection panel', and particularly the Selection Buttons, were new idea, that could not be specifically designed, until a working prototype was tested to provide the desired results. Although the designed haptic selection panel possesses the attributes to reduce error key presses and limit the frustration of do-overs for each error, during the course of ATM or kiosk usage, it does not provide concrete evidence of its attributes. Hence as suggested a working prototype would be developed and implemented with the necessary algorithm to provide the essentially needed evidentiary support, thereby backing up the initial design.

To accomplish this, a sequence of touch switched were designed to mimic the result of the "Haptic Selection Button" (as shown in Figure 8.5), and provide spatial user generated information, which would be encoded into programmable input via a microcontroller and forwarded to a computer terminal for testing and evaluation.

8.4. Selection Panel Hardware Overview

To develop the prototype hardware for a demo "Selection Panel" using 8051-based circuit (explain in Figure 8.6), I needed three PC-based programs and a development board with a monitor ROM.

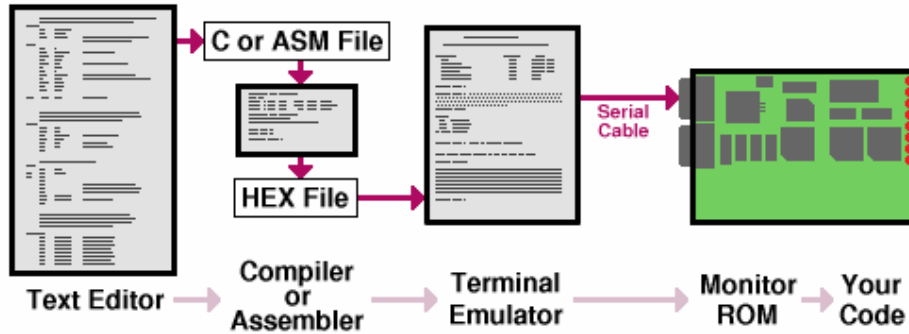

Fig 8.6: The modular breakdown of the System Overview

Because in the requirement specification it was stated that the project would function independent to the platform. Hence, a detailed over view of what has been carried out is thoroughly listed below. The basic tools required in achieving the development requirements are:

1. **Text Editor**

This is where I composed the code that ultimately will run on the 8051 board and make the project functional. All PC operating systems include a text editor. All Microsoft Windows systems have NOTEPAD, which is a very simple editor. Linux systems usually have VI and EMACS installed, as well as several others.

2. **Compiler or Assembler**

After detailed study and experimentation on Assembly language, the ordinary C compiler was chosen, because an intermediate language is preferred as compared to a low level language. It was important to remove all semantic and syntax errors; to do so I have utilized the on board “Atmel compiler”.

3. **Terminal Emulator**

To communicate with the 8051 board, it is necessary to run a terminal emulator program. We will be able to transmit our .HEX file to the board and run its code, observe its results and the information it may send to the serial port, I also used the terminal emulator to examine and manipulate memory with the Monitor ROM. Microsoft provides HyperTerminal with Windows. Linux distributions usually provide ‘minicom’.

4. Monitor ROM

The Monitor ROM is 8051 code that runs when the board boots. It provides interactive menus that allow to download code, run it, manipulate memory and perform other functions. All 8051 development boards come with "pulmon" loaded in the non-erasable internal memory of the 87C52 chip. Using the monitor, it is possible to run the code directly from the board. It is also possible to download the code to a non-volatile memory on the board together with an "auto-start header" that causes PAULMON2 to run the code automatically when the board boots; but this process was ruled out because of the extensive complexity and lack of fund along with limited time available.

8.4.1. ATMEL AT89C51 Pinout and Description

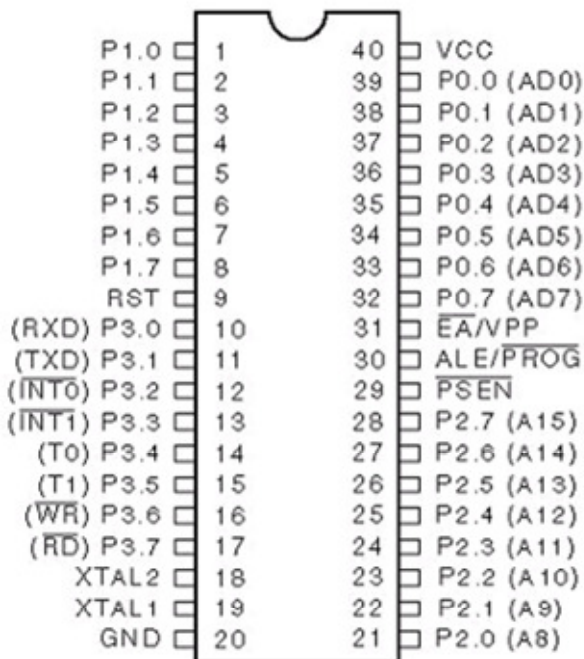

Fig 8.7 Shows the Pin Configuration of the AT89C51 Chipset

The AT89C51 is a low power, high performance CMOS 8-bit micro controller with 4Kbytes of Flash programmable and erasable read only memory (PEROM), pin configuration shown in Figure 8.7 [28, 29]. This device is compatible with the industry standard 8051 instruction set and pinout. The on-chip Flash allows the program memory to be quickly reprogrammed using a non-volatile memory programmer such as the PG302 (with the ADT87 adapter). By combining an industry standard 8-bit CPU with Flash on a monolithic chip, the 8951 is a powerful microcomputer which provides a highly flexible and cost effective solution to many embedded control applications. The 8951 provides the following features:

- ~ 4 Kbytes of Flash
- ~ 128 bytes of RAM
- ~ 32 I/O lines
- ~ two 16-bit timer/counters
- ~ five vector, two-level interrupt architecture
- ~ full duplex serial port
- ~ on chip oscillator and clock circuitry

In addition, the 8951 is designed with static logic for operation down to zero frequency and supports two software selectable power saving modes [28, 29]. The Idle Mode stops the CPU while allowing the RAM, timer/counters, serial port and interrupt system to continue functioning. The Power down Mode saves the RAM contents but freezes the oscillator disabling all other chip functions until the next hardware reset.

8.4.2. ATMEL 89C2051 In-Circuit Programmer

The idea is to add this circuitry to a board with already has RAM at 2000 and an 82C55 I/O chip to provide ports A, B and C [28, 29].

The AND & NAND gates shown should be 74HC08 and 74HC00 respectively. If a TTL type NAND gate is used (e.g, LS, L, S, ALS, etc) the crystal oscillator is used as the clock provided to the main component, the micro-controller [28, 29].

The inputs on the left side of the schematic (Figure 8.8) come from the ports on the 8051 and 82C55. Port A, Port B, and PC.0 come from the 82C55, and the other lines are from the 8051. The TXD pin of the 8051 is connected to the TXD(in) input line, and the TXD(out) line is connected to the line driver for the programmer's serial transmit. This simple three-gate circuit provides the "echo-through" feature which is useful for troubleshooting code while the 89C2051 is in-circuit by echoing data to the programmer's transmit line.

The 15 switches, shown in Figure 8.8, are the gates within the CD4066. Four of these chips are required for the primary finger and palm movements, while another four have been designated to monitor the delay and sequential output for errors in key presses which may or may not be use according to the test case execution stage for verification of the algorithm.

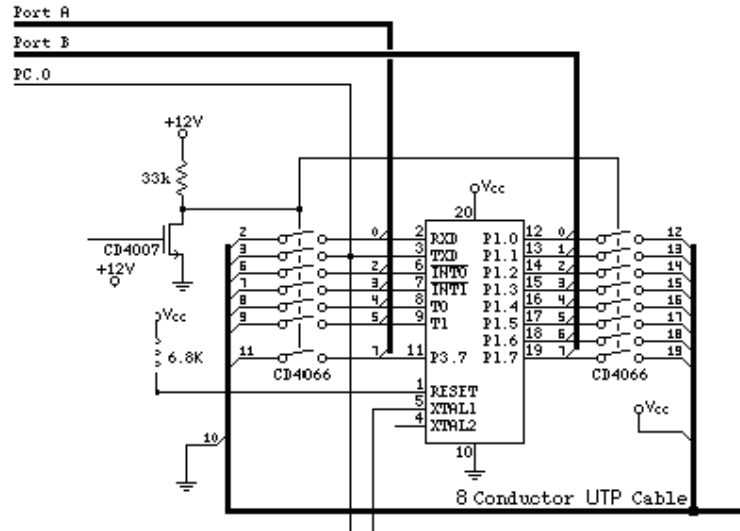

Fig 8.8 The schematic of the switches in the circuit

As suggested in the IC schematic Pin 14 must be connected to +12 volts to avoid damage to this chip. RAM exists at location 0x2000; to store a copy of the data to be programmed into the 89C2051. Hence, the programmed code of the “Key Press Algo” is at this location. The code for the 89C2051 must be assembled at location 0000.

Once execution starts the code is download, beginning at location 0000, it really needs to get stored at location 2000, 001, 002 ... and so on. To accomplish this we just AND's the Y0 and Y1 lines from the 74HC138 chip. However, for the development board example, this prevents the EPROM from working. Hence, that scenario has been removed.

8.4.3. Programmed Code Overview

The above mentioned routines provide an interrupt driven serial input and output, which is intended to replace **CIN** and **COU**T in the serial I/O routines. This code uses separate transmit and receive buffers in *Internal RAM*, so that no external chips are required.

Memory has also been allocated in the 8051's internal RAM. The two buffers may be any size (3 bytes or more each), and they may be located anywhere, even in the indirect-only area (0x80 to 0xFF) in 8052 chips with 256 bytes of internal RAM.

After multiple experimentation with assembly language it was decided that because the AT89C51 IC can be programmed in a C compiler increasing functionality and reducing the size of the program. The assembly language program was altered and a C version of the program was created.

The purpose of this code is to allow our application code to send and receive data via the serial port, without having to wait for each byte. This is done with buffers (internal RAM memory), one for transmitting and one for receiving. When our program needs to transmit data, it will call `cout`. Using the simple polled serial I/O routines, `cout` would check if the 8051's UART is still sending a previous byte and wait until it's done, then put the byte it was given when called into `SBUF` to send it. This code does not wait. Instead, the byte is written into a buffer in memory, and a pointer is changed which tracks what portion of the buffer is holding data. If there is room available in the buffer, this `cout` routine returns to our program immediately. Later, when the 8051's UART is ready to transmit another byte, it will generate an interrupt and the `uart_intr` will transfer one of the bytes from the buffer to the `SBUF` register to send it and update the pointers to reflect that a byte was removed from the buffer. This process allows our program, for example, to send a large message "all at once". Repetitive calls to `cout` place all the bytes into the buffer, and then they are later sent by the UART while our program is free to do other tasks. As long as the transmit buffer is not full, our program may call `cout` and not have to wait for the time it takes the UART to send the bits.

Similarly, for reception of data, the 8051's UART generates an interrupt when it has received a byte. But our requirement specification do not state a data input relationship with the micro-controller. The advantage of using this code is that it allows our program to send a group of bytes, without waiting for each one to be sent, and to receive one or many bytes, without having to regularly poll the `RI` bit. Many applications cannot tolerate waiting while bytes are sent including this specific algo, hence it must be able to receive bytes while the code is busy doing some computation, and later read them from the buffer. The code generates multiple signals on the activation of each of the key presses indicated earlier. Table 8.1 describes the key presses and the signals generated

Action Performed	Signal Generated (Binary)	Signal Decoded as
No Action	XX100000	“ ”
Thumb 1	XX110000	“A”
Thumb 2	XX110001	“AB”
Thumb 3	XX110010	“AC”
Thumb 4	XX110011	“AD”
Index 1	XX101000	“B”
Index 2	XX101001	“BA”
Index 3	XX101010	“BC”
Index 4	XX101011	“BD”
Middle 1	XX100100	“C”
Middle 1	XX100101	“CA”
Middle 1	XX100110	“CB”
Middle 1	XX100111	“CD”

Ring 1	XX100010	“D”
Ring 1	XX100011	“DA”
Ring 1	XX100010	“DB”
Ring 1	XX100000	“DC”

Table 8.1

8.4.4. Modular System Overview

To conceptualize the ‘Haptic Selection Panel’ two boards have been designed. Module A is the Main Board, and Module B is the Finger Selection Pad circuit. User presses switches on Module B and the information is received by Module A. A complete modular flow description is shown in Figure 8.9. The microcontroller on Module A transmits this info to CPU via RS232 (as previously explained in Subsection 9.4.3). For this external device to be recognized as a SCI Device the following communication parameters are preset:

Baud Rate: 9600

Data Bits: 8

Parity: Even

Stop Bits: 2

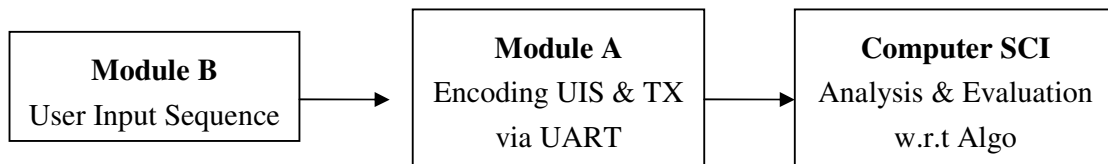

Fig 8.9: The basic flow sequence between the modules of the system

Module A (Main Board):

Module A is the main board for this project. It contains an Atmel AT89C51 Microcontroller (as discussed earlier). There are pin headers available for connecting 6-Wire cables to Module B. Each header is named for corresponding Finger, e.g. ‘Index’, ‘Middle’ etc. A power source of 9 V is to be connected to Module A. There are two DB9 connectors available on Module A, as seen in Figure 8.10. One is for downloading program code to the MCU memory, the other is for serial communication with the PC.

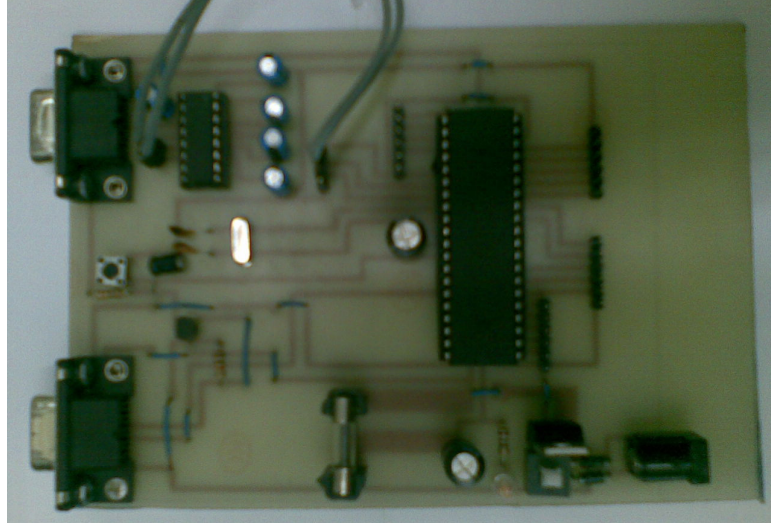

Fig 8.10: Microcontroller and UART Circuit on Module A

Module B (Finger Pad)

No power source is needed for Module B. This module has switches arranged for the four digits of the right hand, i.e. (Thumb, Index, Middle, and Ring fingers), as seen in Figure 8.11. It connects to Module A via the 6-Wire cables mentioned in previous section. The cables are being connected to Module A so that the ground connections of both the circuits are connected together. At the time of first testing the three way pressure switched gave way, through the PCB and disconnected the soldered connection at the back. For this reason currently these switches have been replaced by normal two way switched, and the necessary changes made to the on board programme. However, if in the future it is decided to add such functionality, it is possible to, then solder them on the board and connect the jumper wires.



Fig 8.11: The finger selection buttons on Module B

Communication:

Once both modules are connected properly and Module A is connected to CPU via RS232 according to the parameters specified earlier; the basis calibration can be made using MS HyperTerminal. Once all the parameter have been configured the device generated the bit patterns shown in Figure 8.12

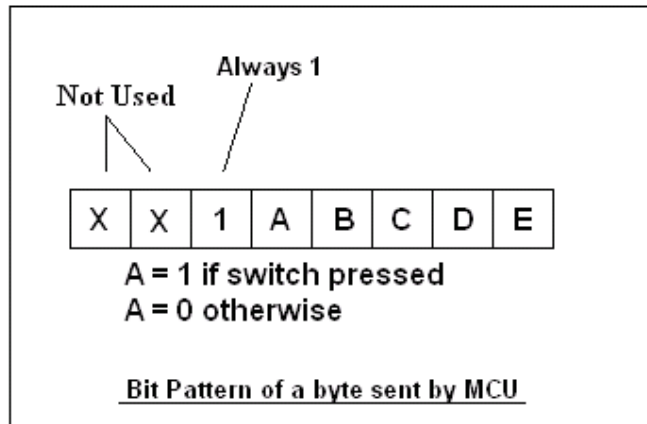

Fig 8.12: MCU's Bit Stream Pattern

On power up, Module A starts sending bytes of data corresponding to the switches' states on Module B. For each iteration Module A, sends five bytes of data to CPU, a starting byte plus four bytes one each for one finger. This single byte corresponding to one finger has the following bit pattern as seen in Figure 8.2 (also shown in Table 8.1).

Action Performed	Signal Generated (Binary)	Signal Decoded as
No Action	XX100000	“ ”
Thumb 1	XX101000	“A”
Index 1	XX100100	“B”
Middle 1	XX100010	“C”
Ring 1	XX100001	“D”

Table: 8.2: The four basic input stream samples

8.5. Usability Test and Results

To validate the system's credibility and to collect user feedback, it had been decided to conduct an evolutionary survey and usability test. To ensure that a complete array of design functionalities can be tested several use case scenarios were listed. A dummy UI was created to mimic an ATM interaction.

Algorithm

The fundamental purpose of the algorithm is to filter out the error key inputs which may be pressed during a normal ATM interaction session. The prototype hardware module B consists of 4 array of 'Finger Based Selection Buttons' which means that, there are button arrays for 'Index', 'Middle', 'Ring' and 'Thumb'; each consisting of 3 touch switches and one pressure switch (see Figure 8.11), Each of the three simple touch switches, when pressed produces a corresponding electrical impulse which is forwarded to the microcontroller. The microcontroller encodes the signal and forwards the signal to the UART and the computer port. The pressure switch in each finger based selection button produces 4 distinct electrical impulses that are also encoded and sent to the UART. The UART send the 8bit signal periodically to the serial port (see Fig 9.12 and Table 8.1). There is a java based programmed algorithm being run of the PC which recognized the signals being sent to the 'COM' port and updates the LOC table. (A LOC table is a historical collection of all the COM port data classified according to each 'Finger Based Selection Button') Hence, whenever any port data is received the LOC table is updated to show which ones and how many switches were pressed in the given iteration.

Over the passage of research of motor disabilities (like arthritis and Parkinson disease, see Section 4.1 and 4.2) finger movement of a range of disabled users were monitored and a weight-age system was assigned to the movement of each finger according to the voluntary and involuntary tremors produced during a single key selection. Hence, once the LOC table is updated, each switch impulse is multiplied by the weight-age assigned to it. After the calculation of multiplier weight-age coefficient and its aggregate, the total value of each finger button is added. The greater the additive value of any finger key the more chances are that the user was intending of pressing that particular key and, hence, the intended key is calculated.

Using this information of how many switches were pressed multiplied by the relevant weight-age coefficients, aggregated and compared for each finger key intended key pressed were recorded during the survey and tallied to match use-case scenarios.

Use Cases

As mentioned earlier a Java based application was run in the foreground which acted as dummy ATM transaction software (see Figures 8.13a, 8.13b and 8.13c). This software collected all the key presses during a session and displayed the live results to another linked machine for runtime evaluation.

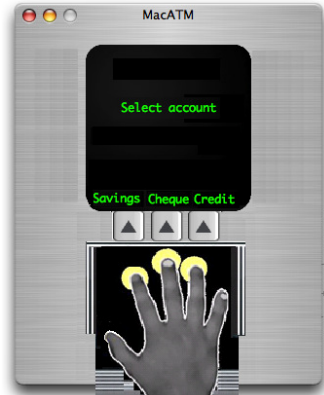

Fig 8.13a: ATM Transaction Software UI Case 1

There were eight participants in the usability test. The participants were given five sets of similar use cases, but asked to perform them in different order from each other (see figures 8.13a, 8.13b & 8.13c). During the selection process the user PC did not display any of the selections being made. Hence the user did not know if the wrong selection was made at any time.



Fig 8.13b: ATM Transaction Software UI Case 2

After each use case was run successfully the user was asked to confirm their selection to be correct, and after this the said selection was recorded and the next use case was displayed. After the completion of the test each user was questioned on the difficulty of hardware and software.



Fig 8.13c: ATM Transaction Software UI Case 3

Results

The results of the evolutionary survey and usability test were in accordance with the design aspirations. Out of the 40 cases 39 cases produced 100 results, since one case was not registered due to hardware error. The participants classified the selection process as either easy or relatively easy (1 or 2) in a difficulty level of 5. There where, however, certain issue related to visual confirmation of each key pressed, due to the fact that the participants very not able to see their own selection during the test. The usability test confirmed the hypothesis that the designed structure is sound and can be implemented effectively.

9. Discussion and Future Research

This research has proven to be very interesting and greatly rewarding. The area of research is personally close to my heart due to some disabilities in my family; hence it has been a proactive incentive. The basic purpose of the research was to construct an idea of the usability issues that the target audience faces in day to day interactions with public computing machines, especially ATMs. As the research began it was made abundantly clear that usability issues can only be pointed out in the field and by users who experience them first hand, everyday. To ensure that the impact of each usability concern is realized to the fullest and that technology or usage bias does not influence the results, a set of surveys and questioners were asked to be filled out on location, by the participant, who were from a multitude of age groups and nationalities (carried out in the summer of 2008). Once the ‘control’ survey results were analyzed and documented specific areas of interests were highlighted and targeted for the next string or surveys.

In the second string of surveys, ATM users with specified disabilities from motor impairment to visual disabilities (see Chapter 3), were asked to record their experiences of interacting with PCMs especially ATMs in the survey questionnaires. The collection of this data was analysed and evaluated to streamline the core research target, of ‘How to resolve the basic interaction concern of the target audience’. To ensure that there are finite and tangible deliverables, as a direct result of this thesis work, it was decided that an improved design would be put forward utilizing the survey results as well as coming up with basic alterations to the current ATM design to facilitate the target audience, as much as possible, without a complete redesigned structure.

Ensuring that a substantial design contribution can be made during this research work, previous design effort and design guidelines were reviewed [3, 32, 37] and evaluated (see Chapter 5 and 6). A new and revolutionary design of a haptic Braille surface was introduced in the design which not only acts as a touch display unit for the visually challenged but also provided tactical/haptic assistance for the users with motor impairment or muscular dystrophy (see Section 8.4). This design, can be considered very helpful (in theory) for motor impaired users, but such a device has not been designed or developed to date and hence it is presumptuous to relate effective results to such a device. Therefore, it was agreed upon to construct a working prototype of this part of the device functionality (Haptic Selection Buttons) using a stream of physical input switches connected to an ‘Error Filtering Algorithm’ (see Sections 8.4 and 8.5). Hence, using the a stream of touch and pressure buttons linked to a microcontroller, an

array of inputs were gathered and passed through an 'Error Filtering Algorithm', which removed the unnecessary error presses, by the motor impaired users and displayed the intended selection of the user. This prototype was also tested by participants in real word environments to ensure that the system behaviour can be considered reliable, and the results supported the research (Section 8.5).

During the latest UI test, where the prototype hardware was presented to the participants, who were provided with a set of use case scenarios, it was made clear via the results that the target user group required a new revolutionary designed system to boost the diminished usability. The research shows that current information kiosks and ATMs lack the versatility and usability to provide effective accessibility to disabled users. The results also provided the necessary evidence that the proposed system can be effectively implemented to increase accessibility to such systems for the target users. However it was also clear that an extensive empirical study of the completed design is required to validate the finding of this research

The entire research process was effectively streamlined from the start to accomplish maximum results. However, as is the case with most research projects of this nature, there were a number of obstacles which proved difficult to overcome. Considering the research, it was very important to gather user-interaction data on a large scale. As planned, surveys and usability questionnaires needed to be circulated and filled at the source of interaction, example ATM usage. This would not have been an issue if most of the target audience, such as senior citizens and disabled users, were interviewed in their native language. Unfortunately due to my limited skills in the native language, this process proved more of a challenge than previously envisioned. To cater to this new requirement, all the forms were translated in not only Finnish, but Swedish, Russian, German and Urdu. Even then it was observed that most natives understandably felt considerable hesitation when approached by a foreigner, after their interaction with ATMs. To resolve this issue, help from a native Finnish speaker was taken to approach and explain the reason of the surveys.

Another issue which was not anticipated during research planning came up while designing and implementation of the prototype hardware. According to the original design, the components specified were not readily available in the local markets. My experiences with electronic equipment of this nature were considerably limited, and hence the substitute hardware used, was completely new and challenging to use, in the given timeline. This issue became quite a challenge when the microcontroller had to be replaced completely due to the limited availability of the specific model in the local markets. A complete rework of the initial design had to be drafted before the final

implementation process could commence. However, after considerable research and testing the necessary components were tested on draft circuits and approved for final design. Additional components were brought in from England to ensure the success of the final design. Once the final design was approved, it became easier to construct the prototype. Other issues, example faulty hardware, and component breakage, during testing also needed to be managed. However, the most important breakage issues arose during one of the usability tests, which was documented during the results of survey three, and later the error results were labelled as hardware failure to ensure the research findings were not influenced in anyway. All in all, the entire research process proved to be professionally challenging as well as greatly rewarding. This whole experience provides impetus to carry on the research further, as considerable work still needs to be done in designing a breakthrough interaction system for the target audience.

Future Development and Research

Although the current stream of research has yielded significant results and generated motivation to design concrete and easily intractable interfaces to facilitate the disabled uses, it still lacks the necessary ground results of actually developing a complete structure that can replace the antiquated and laborious systems of today. Furthermore, the results of all the surveys conducted during the research clearly state that a large number of the target audience are not satisfied with the technology available or the usability issues that it generates.

In light of this information perhaps the way forward is to utilize recent technologies to bridge the gap between an effective design and an effective end product. Currently most research effort concludes the need to create more and easily usable interfaces, which are more natural in interaction and simple to understand for first time users. Perhaps, instead of creating similar UI structures to facilitate HCI, we should focus on reducing the multiple number of interfaces and focusing on single interface solutions. This could perhaps finally put to rest the age old problem of designing & evaluating usability: suited for all possible users of any given system

Single UIs are not new for us, and much research has been done in this field. It seems to be the natural course of technology evolution that should fuel our future development. We have implemented technology into so many aspects of our lives that it was natural to be overwhelmed by the sheer number of UIs at some point. This dilemma has hit the disabled users the most, due to, the lack of UI experience and the limitation of their respective condition. Because of this, it is these users that stand to gain the most from the unification of UI controls.

According to new and evolved available technology such as NFC, Bluetooth 3.0, Haptic Guided Navigation, augmented reality, it is truly possible to create a hand held device (even a mobile), to provide a single interface, for all the possible day to day UIs that a user must interact with. All that is actually required is to perfect this single interface, customized for its specific user; by providing a truly multimodal approach, which is specifically User-Centred, and not generic in nature. Hence a visually disabled user can be haptically guided to his nearest ATM, and using his single interface service (say a mobile phone) authenticate and extract money for his evenings doctor's appointment. Similarly a wheelchair user with a congenital condition can walk through 'Times Square' for the first time, during rush hour; while he is guided to the closest subway, for his return ticket.

These examples may seem like science fiction but are not. Many technologies have evolved and matured into complete science. Nokia is in the final stages of launching its third and fastest mass produced NFC mobile device to date, the 6131 NFC [39], which can be used as electronic wallet. The release of Bluetooth SIG [37] in April this year has made it simple to create secure, limited wireless connection without the hassle implementing Wi-Fi standards. Similarly the year 2009, will see the development of the most compact and portable Augmented Reality Systems [ISMAR 09], which promise to raise, usability and profitability of the science [38]. Haptics has been embraced with open arms to the mobile technology field and is currently navigating its way to portable systems. All this proves that most of the ingredient to 'Single User Interfaces' are ready, and that it is a matter of time before we embark on the journey from Multiple and Complex UI Controls to single and personalized UICs or perhaps even to Ubicom Computing.

Summary

The main purpose of the research is to highlight usability and accessibility concerns for disabled users of information kiosks and ATMs. Due to the expanding features of today's IKs and ATMs the limited controls provided on such machines have become less constructive, and hence more complex to manipulate. The fact that these controls are designed to be synthetic, instead of natural and fluent in use, has made it very difficult even for regular users. There is an ever growing need to incorporate multi-multimodal interaction techniques to such machine to provide more usability control and facilitate ease of use. For the visually limited and motor impaired users interaction with such machines has become even more of an issue. There usability concerns have morphed into accessibility issues which limit them from accessing such machine, altogether. This issue has not been actively pursued due to the basic fact that such disabled users constitute a very tiny percentage of the users groups and IKs and ATMs are traditionally commercial products targeted for the masses. However, in the last five years a considerable amount of research, both in the public and private sector has been carried out to bridge the usability gap between the different types of users of the IKs and ATMs, including the visually and motor impaired users.

This research tried to specifically identify the concerns of the disabled users and to design a prototype that can remove them. For this purpose an extensive array of surveys were carried out to isolate the prime obstacles that may exist for the user group. These studies show that an overwhelming 91% of the users under the age of 35 prefer ATM transactions however, out of the 72 disabled users only 73% preferred to use ATMs, if the help of their partner, friend or family member was available. Amongst the disabled a disturbingly large 17% of the users found the use of ATM to be difficult or impossible and preferred to approach the bank tellers for their financial needs (see Section 6.4). It was noted during the survey that disabled users complained about use of too many technical or financial jargons, the unnatural interaction process (putting physical and mental strain) and the lack of assistive or alternatives hardware for them

Using the results from the study it was decided to construct an implementable design, which could cater to the special needs of the target users groups. For this purpose a multimodal architecture, prototype hardware was designed. To ensure it was viable, a limited usability test was conducted. Although the test was not extensive in nature, it does prove that, the current system needs to be altered, and that a multimodal approach, with haptic interaction is the way to go for the future.

An empirical study is planned for the future, to try to streamline the designed hardware and propose an actual structure that can completely replace the antiquated and laborious systems of today. Currently, it is possible to utilize NFC technology in hand held devices to authenticate and validate financial transactions, whereas, using Bluetooth 3.0, it is now easier than ever to construct secure wireless connections. Perhaps the true future of single purpose devices is at an end, and users, especially the disabled, can benefit from accessing IKs and ATMs through their own personal handheld devices, that can utilize NFC and Bluetooth technology to make interaction with kiosks seamlessly simple and familiar, bringing us closer to the real goal of this research that disabilities of any kind should not play any role in computing ability of an individual.

References

- [1] Immersion Solutions, accessed Dec 2008
http://www.immersion.com/industrial/docs/TouchSense_Solutions_may08v2.pdf
- [2] Immersion Corporation The Haptics, VibeTonz and TouchSense company July 16, 2008, accessed Dec 2008
<http://www.equitygroups.com/nasd/immr/messages/139353.html>
- [3] Designing with Haptic Feedback by Karon E. MacLean Interval Research Corporation
<http://www.cs.ubc.ca/~maclean/publics/icra00-DesignWithHaptic-reprint.PDF>
http://ieeexplore.ieee.org/xpl/freeabs_all.jsp?arnumber=844146
- [4] Aladdin: Exploring Language with a Haptic Door Knob by Karon E. MacLean
<http://www.cs.ubc.ca/~maclean/publics/IntTR-Aladdin.PDF>
- [5] Haptics Research in TAUCHI: Aiding Visually Impaired Children and Enabling Haptic Interaction by Roope Raisamo at Tampere Unit for Computer-Human Interaction (TAUCHI) Department of Computer Sciences
http://www.dcs.gla.ac.uk/haptic/haptics%20web%20pages_files/Raisamo.pdf
- [6] *User friendly selection apparatus based on touch screens for Visually Impaired.*
www.freepatentsonline.com/7187394.html, accessed Dec 2008
- [7] E-government for the disabled: service through text-to-speech and speech recognition technologies, accessed Dec 2008
http://www.editlib.org/index.cfm?fuseaction=Reader.NoAccess&paper_id=26721&CFID=8808016&CFTOKEN=39108558
- [8] Use of audio-haptic interface techniques to allow nonvisual access to touchscreen appliances Gregg C. Vanderheiden at Trace R&D Center, University of Wisconsin-Madison
http://trace.wisc.edu/docs/touchscreen/chi_conf.htm
- [9] Cross Product, Cross Disability Interface Extensions: EZ Access”, by Gregg C. Vanderheiden et al.
http://trace.wisc.edu/kiosks/ez/resna_ez_access_paper.html
- [10] Novel Shoulder-Surfing Resistant Haptic-based Graphical Password by Behzad Malek Mauricio Orozco Abdulmotaleb El Saddik Multimedia Communications Research Laboratory University of Ottawa, ON, Canada
<http://www.mcrlab.uottawa.ca/confs/2006/EH2006Final.pdf>
- [11] Haptic-Based Sensible Graphical Password by Mauricio Orozco¹, Behzad Malek², Mohamad Eid¹, and Abdulmotaleb El Saddik¹ Multimedia Communications Research Laboratory (MCRLAB) School of Information Technology and Engineering (SITE) University of Ottawa, ON, Canada
http://www.discover.uottawa.ca/publications/files/VC2006Mauritz_V6.pdf

- [12] Siemens Haptic ID Card
http://w1.siemens.com/innovation/en/news_events/innovationnews/innovationnews_articles/2008/e_21_ino_0807_1.htm
- [13] Haptics Opens M-Commerce Door By Brad Smith WirelessWeek - September 15, 2004 accessed on 10 Nov 2008, accessed Dec 2008
<http://www.wirelessweek.com/haptics-opens-m-commerce-door.aspx?terms=>
- [14] Fujitsu for FeliCa F900iC 3G FOMA an M-Commerce tool for the Japanese Market, accessed Dec 2008
<http://wirelesswatch.jp/2004/06/08/fujitsu-for-felica-f900ic-3g-foma/>
- [15] ECMA Internation Near Feild Communication June 2004
<http://www.ecma-international.org/activities/Communications/2004ga-067.pdf>
- [16] Enabling Disabled Shoppers: Multi-channel retailers, meet your multi-abled shoppers, who have money to spend By Lynne Brown Jan 2008, accessed Dec 2008
<http://www.internetretailer.com/article.asp?id=24897>
- [17] Opti-Wall Kiosk Improves Access for the Disabled: News Release from: Rittal Limited 05/09/2008 accessed May 29, 2008
<http://www.engineeringspecifier.com/Industry-News/Opti-Wall-Kiosk-Improves-Access-for-the-Disabled.asp>
- [18] The Quad Media ESS Ballot box
<http://quadmedia.com/>
- [19] Electronic Voting in Australia for Military Personnel and the Disabled Oct 2006, accessed Dec 2008.
<http://www.tomw.net.au/blog/2006/10/electronic-voting-in-australia-for.html>
- [20] ENVOY Online Kiosk
<http://www.amaticakiosk.com/casestudies/health/nhs.asp>
- [21] VFIT, accessed Dec 2008
<http://www.formalogix.com/formalogix/product/product.htm>
- [22] Diebold – Vectra, accessed Dec 2008
<http://www.diebold.com/solutions/default.htm>
<http://www.balanceinc.com/portfolio/diebold>
- [23] Health Information Portal by EMIS
<http://www.emis-online.com/products/health-information-portal/>
- [24] One Laptop Per Child Project (OLPC May 29, 2008), accessed Dec 2008
<http://internetbestsecrets.com/2008/05/olpc-2-to-add-multitouch-and-haptic.html>
- [25] I-drive in BMW
http://www.bmw.com/com/en/insights/technology/technology_guide/articles/idrive.html
- [26] Amyotrophic Lateral Sclerosis (ALS)/Lou Gehrig's Disease

<http://www.neurologychannel.com/als/> - external link

[27] Motor Disabilities by WebAIM a non-profit organization within the [Center for Persons with Disabilities - external link](#) at [Utah State University](#)
<http://www.webaim.org/articles/motor/motordisabilities.php>

[28] Atmel 89C51 Microcontroller Data Sheet, from Atmel
http://www.atmel.com/dyn/resources/prod_documents/doc0265.pdf

[29] 80C51 8-bit microcontroller family 4K/8K/16K/32K Flash - Data Sheet from Philips
http://www.datasheetcatalog.com/datasheets_pdf/8/9/C/5/89C51.shtml

[30] Ashley Montagu (1986) *The Mind of the Skin, from Touching*, (third edition), Harper & Row, NY

[31] R. Weber (1990) *A Philosophical Perspective on Touch*, In Barnard, K.E., Brazelton, B.,T. (eds.) (1990) *Touch: The Foundation of Experience*, International Universities Press, Inc. Madison, CT

[32] Slavko Milekic, Psychology of Touch: *Mother of All Senses*.

[33] Brazelton, B. (1995). *Fetal Observations: Could They Relate to Another Modality, Such as Touch*, In Field, T. (ed.) *Touch in Early Development*, LEA, NJ, 1995

[34] Diamond, M. (1990) *Evidence for Tactile Stimulation Improving CNS Function*, In Barnard, K.E., Brazelton, B.,T. (eds.) *Touch: The Foundation of Experience*, International Universities Press, Inc. Madison, CT

[35] Klaus, M. (1995) *Touching During and After Childbirth*, In Field, T. (ed.) *Touch in Early Development*, LEA, NJ, 1995

[36] Thayer, S. (1982) *Social Touching*, in Sciff, W., Foulke, E. (eds.) *Tactical perception: a sourcebook*, Cambridge University Press, NY

[37] Bluetooth Technology gets Faster with Bluetooth 3.0 by SIG Release
 21-Apr-2009 Bluetooth SIG

http://www.bluetooth.com/bluetooth/press/sig/ibluetoothi_technology_gets_faster_with_ibluetoothi_30.htm

[38] ISMAR 09 (International Symposium on Mixed and Augmented Reality)
<http://www.ismar09.org/>

[39] Nokia 3rd Gen NFC Device 6131
<http://europe.nokia.com/find-products/devices/nokia-6131-nfc>

[40] Karon E. MacLean, Designing with Haptic Feedback, Interval Research Corporation
<http://people.cs.ubc.ca/~maclean/publics/icra00-DesignWithHaptic-reprint.PDF>

[41] Roope Raisamo, A Multimodal User Interface for Public Information Kiosks
Department of Computer Science, University of Tampere

<http://www.cs.ucsb.edu/conferences/PUI/PUIWorkshop98/Papers/Raisamo.pdf>

[42] Mecheal Johnston and Srinivas Bangalore, MATCHKiosk :A Multimodal Interactive City Guide at AT&T Research, Florham Park

<http://www.research.att.com/~johnston/papers/johnstonbangalorecolinga104.pdf>

[43] Andrew C. Christian and Brian L. Avery, Digital Smart Kiosk project, ACM Press, 1998, 155-162.

[44] François Grize and Mehdi Aminian, Cybcérone – A kiosk information system based on the World Wide Web and Java, *Interactions* 4 (6), 1997, 62-69.

[45] Raymond Lau, Giovanni Flammia, Christine Pao, and Victor Zue, WebGALAXY: Beyond point and click – a conversational interface to a browser, *Proceeding of Sixth International World Wide Web Conference*, 1997, 119-128.

[46] A. Life, I. Salter, J.N. Temen, F. Bernard, S. Rosset, S. Bennacef, and L. Lamel, Data collection for the Mask Kiosk: WOz vs prototype system, *Proceeding of International Conference on Speech and Language Processing (ICSLP'96)*, vol. 3, 1996, 1672-1675.

[47] Stephanie Seneff and Joseph Polifroni, A new restaurant guide conversational system: issues in rapid prototyping for specialized domains, *Proceeding of International Conference on Speech and Language Processing (ICSLP'96)*, vol. 2, 1996, 665-668.

[48] Immersion Corporation FORM 8K Current Report, *Immersion Corporation* 801 Fox Lane, San Jose, CA 95131 USA

http://www.google.com.pk/url?sa=t&source=web&ct=res&cd=2&url=http%3A%2F%2Fshareholder.api.edgaronline.com%2Fefx_dll%2Fedgarpro.dll%3FFetchFilingRTF1%3Fsessionid%3DDY32jW8uJKxHsTY%26ID%3D6348409%26PageBreakStyleID%3D2&ei=mcSuK1JsmGIAf6o92_DA&rct=j&q=Immersion+Corporation+%26+Atrua+Technologies+Products&usq=AFQjCNHdcSVWTtz0xIPYzJyZawJiqQz2pA

[49] Samsung First to Launch Digital Music Player With Immersion's Touch Feedback, *SAN JOSE, Calif. & LAS VEGAS, Jan 08, 2009*

<http://ir.immersion.com/releasedetail.cfm?releaseid=358108>

[50] Samsung's Haptic 2 Phone First to Use Immersion's VibeTonz[®] System for User Design of Touch Feedback, *South Korean Sales of More Than 75,000 Units in the First Three Weeks Shows Popularity of Haptic-Enabled Phones*
<http://ir.immersion.com/releasedetail.cfm?releaseid=342652>

[51] Samsung SCH-W559 Mobile Phone with Immersion's VibeTonz System for Tactile Touchscreen Feedback
<http://www.gizmag.com/go/6745/>

[52] How People with Disability Use the Web:
<http://www.w3.org/WAI/EO/Drafts/PWD-Use-Web/>

[53] Colour and Depth Perception for the visually challenged
Accessibility Color Wheel: <http://gmazzocato.altervista.org/colorwheel/wheel.php>
Color Contrast: <http://www.lighthouse.org/accessibility/effective-color-contrast/>
Contrast Analyser: <http://www.paciellogroup.com/resources/contrast-analyser.html>
Color Doctor: <http://www.fujitsu.com/global/accessibility/assistance/cd/download.html>
Vischeck: <http://www.vischeck.com/vischeck/vischeckURL.php>

[54] Bad UI design examples for Disabled users:
<http://websiteshatsuck.com/>