



MOHAMMED IBN MUKHTAR

Implementation Strategies in
Reforming Public Organisations

Leadership and Processes



ACADEMIC DISSERTATION

To be presented, with the permission of
the board of the School of Management of the University of Tampere,
for public discussion in the Paavo Koli Auditorium,
Kanslerinrinne 1, Tampere,
on February 10th, 2012, at 12 o'clock.

UNIVERSITY OF TAMPERE

ACADEMIC DISSERTATION

University of Tampere
School of Management
Finland

Copyright ©2012 Tampere University Press and the author

Distribution
Bookshop TAJU
P.O. Box 617
33014 University of Tampere
Finland

Tel. +358 40 190 9800
Fax +358 3 3551 7685
taju@uta.fi
www.uta.fi/taju
<http://granum.uta.fi>

Cover design by
Mikko Reinikka

Acta Universitatis Tamperensis 1705
ISBN 978-951-44-8723-1 (print)
ISSN-L 1455-1616
ISSN 1455-1616

Acta Electronica Universitatis Tamperensis 1172
ISBN 978-951-44-8724-8 (pdf)
ISSN 1456-954X
<http://acta.uta.fi>

Acknowledgements

Writing this document has been an enormous learning and arduously experiential. My quest for knowledge, understanding, skills and capabilities have not been in vain as a result. The next step of challenge having created this invention is to follow its contents and process for societal innovation, improvement and or development. This is so because it has been an established fact that knowledge is irrelevant until brought to bear on humankind welfare purposes. However, this cannot be done in isolation but with people as this study processes had been and will continue to be. Thenceforth, recognizing and showing appreciation is a necessity.

My very first special thanks go to Professor Risto Harisalo, my main supervisor, whom I have “terrorised” most in this process. The next is to Professor Emeritus Markku Teemes and Professor Timo Aarrevaara both of Helsinki University for their role as the external reviewers of the manuscript and their invaluable comments and suggestions. Also, to my maiden supervisor Professor Jari Stenvall who is now at University of Lapland. Thank you to Ms Tea Vellamo and Dr Jani Rajaniemi for writing the Finnish version of the abstract. Additionally from the latter, Kari Kuopala and Juuso Nurminen thank you for reading and interpreting Finnish related literature to me in English and for the answers to some of my questions. My thanks to you Dr David Teye Doku for reading through chapters to manuscript while providing useful suggestions. The process of thanking continues to Professors Juha Vartola and Ismo Lumijärvi and the rest of the staff who might have assisted in diverse forms. Thank you all for your support both in Finland and from Ghana – my family and friends: Alhaj Baryeh, Numbo Boye, Abena Otubea, and Jonathan Tetteh-Lartey.

Tampere: January 2012.

Mohammed Ibn Mukhtar

Abstract

The purpose of the study had been to find out how the Finnish Senior Civil Servants Management Development Policy had been/is being communicated for implementation since 2002 up-to-date. To do this involved two processes: the policy content reviewed for understanding and relevance; and its subsequent implementation communication. This study is a qualitative brand of interview technique; interpreted by content analysis following the hermeneutical tradition making it contextual. A total number of 37 top government managers and related personnel were interviewed. Government papers and websites alongside relevant literature are reviewed. The Finnish manager development policy invention dubbed Vision 2012 is new and purely a civil servant construction neglecting its environment. The very core finding is the decapitation of the true future leader; the very vision it seeks for, out of the policy and its implementation process.

The rest include a deflection of the policy goals, a fragmented silo-slab system and thinking, purely based on expertise and substance, politics and, of course, ubiquitous self-interests and values against the nation's own. Communication difficulty is, perhaps, the most aside understanding the very idea of the reform. It was found that none including the reformers themselves seems to have a clear understanding and wholistic picture of the reform as a national issue; and, the reformers extraction capability is very weak and, with no Implementation Communication plan. As a result, too much is taken for granted and offered to chance. The results leave the managerial leaders in their comfort zones without commitment, value-will capacity and skills for progress for both self and national development.

It also was found that the policy begun informally and tactically avoiding the power-interest brokers and failed to mix and blend with the formal for coherence and consistency, fertilisation and progress of the entire system. Without the processes of communication and coordination such a joined up process appeared problematic and unworkable. The conclusion is that no innovative processes were identified besides the tensed fixed term contracting strategy on piloting. A structural review and the Finnish government manager's cooperation and performance delivery based on communication, individual direct and oversight responsibility to be based on national interests and values are the future challenges. A manager need assessment, alongside a value-will model and the theory of a silo are posited for possible processes of crafting, structuration and institutionalisation.

Key words: Silo, Management Development, Process, Implementation, Implementation Communication, Implementation Properties – understand, will, capability and culture.

Tiivistelmä (Abstract in Finnish)

Tämän tutkimuksen tavoitteena oli selvittää, kuinka: ”*Ammattimaiseen Johtamiseen Valtionhallinnossa - Johdon kehittämisen Strategia 2002-2012*” (Visio 2012) viestitys on onnistunut. Selvitys sisälsi kaksi prosessia: poliittisen sisällön arviointi ymmärryksen ja merkityksen näkökulmasta, sekä siitä seuraavasta toteutuksesta viestiminen. Tämä tutkimus on laadullinen haastattelututkimus, jonka metodina on käytetty hermeneuttista sisällön analyysia. Haastateltuja oli kaikkiaan 37. Haastateltavat olivat valtiojohdon korkeimpia edustajia tai heidän asemaansa vastaavia henkilöitä. Aiheeseen liittyvän kirjallisuuden lisäksi tutkimuksessa on hyödynnetty valtiollisia asiakirjoja sekä verkkosivuja.

Visio 2012 on uusi puhtaasti julkisen hallinnon rakenteisiin keskittyvä ohjelma. Ohjelma ei ota huomioon hallintoa ympäröivää yhteiskuntaa. Avainlöydöksenä voidaan pitää tulevaisuuden johtajuuden epäonnistumista, vaikka ohjelman tarkoituksena oli nimenomaan tulevaisuuden valtiohallinnon johtajuuden löytäminen. Tutkimuksen muita löydöksiä olivat poikkeaminen hallinnon tavoitteista, sekä virheellinen ajattelu, joka perustuu puhtaasti alakohtaiseen erikoisosaamiseen, politiikkaan ja kaikkialla läsnä olevaan valtion etujen vastaiseen oman edun tavoitteluun.

Kommunikointivaikeudet olivat seurausta uudistuksen tavoitteiden ymmärtämistä vaikeuksista. Tutkimuksessa selvisi, ettei kukaan uudistusta valmistelleistakaan ollut selvää käsitystä ja kokonaisvaltaista kuvaa uudistuksesta kansallisella tasolla. Uudistuksen valmistelijoiden erottelukyky ja toteutukseen liittyvät viestimistäidot olivat heikkoja, jonka seurauksena paljon jäi sattuman varaan tai otettiin itsestäänselvytyksi. Tulosten mukaan johtajat jättäytyvät omille mukavuusalueilleen ilman sitoutumista, tahtotilaa, kykyä ja taitoja itsensä tai kansalliseksi kehittämiseksi.

Tutkimuksessa selvisi myös se, että menettelytapa alkoi epämuodollisesti ja taktisesti vallan välittäjiä vältellen. Se epäonnistui hallinnon virallisessa yhdenmukaistamisessa sekä koko järjestelmän rikastamisessa ja kehittämisessä. Ilman kommunikointia ja koordinoitua yhteistä prosessia muodostui ongelmalliseksi ja vaikeaksi toteuttaa. Lopputuloksena voidaan todeta, että innovatiivisia prosesseja ei tunnustettu, lukuun ottamatta pilotoinnin sopimusstrategiaa. Rakenteellinen arviointi sekä suomalaisen valtiojohdon virkamiesten kansallisiin etuihin ja arvoihin perustuva yhteistyö, kommunikointi saavutuksista, ohjaus ja seurantavastuu ovat tulevaisuuden haasteita. Tahtotilan lisäksi johtajat tarvitsevat hallinnon muokkaamiseksi, rakentamiseksi ja institutionalisoimiseksi arviointia sekä teoriaa siiloutumisesta.

Avainsanat: siiloutuminen, johtaminen, kehittäminen, prosessi, toteuttaminen, toteutuksesta viestiminen, toteutuksen ymmärrys, toteutushalu, toteutuskyky ja toteutuskulttuuri

CONTENTS.....	PAGE
ACKNOWLEDGEMENTS.....	10
ABSTRACT	11
TIIVISTELMÄ (ABSTRACT IN FINNISH).....	12
LIST OF FIGURES/TABLES	17
LIST OF ACRONYMS	18
I INTRODUCTION	12
II BASIC CHOICES OF THE STUDY.....	16
1. Setting the main question.....	16
2. Setting scientific and practical goal for the study.....	23
3 Setting out the main point of view of the study.....	25
III CONCEPTUAL AND THEORETICAL FRAMEWORK.....	29
1. Main Concepts	29
1.1 The Finnish Environment and Institutional Approach	32
1.2 Organizational Culture and Historic Analysis of Finland	33
2.0 The Weberian Rational-Legal Bureaucracy and Culture.....	41
2.1 The New Public Management (NPM)	45
2.1.1 The New Public Management and the public manager.....	46
3.0 The Public Manager Policy Environment	47
3.1 Structuration process.....	47
3.2 Collective Commitment.....	53
3.3 Value-Will Theory.....	56

3.3 Reforming Cultural processes.....	65
3.4. The Management Development Process and the Government Manager	68
3.4.1 The manager job	68
3.4.2 Management and the public manager	71
3.4.3 Manager Development and (Reform) Processes	72
3.4.4 The Craft perspective and process.....	76
3.4.5 The Elusive Management Development Process.....	79
4.0 The Finnish Senior Civil Service Vision 2012 Reform.....	87
4.1 Administrative reform characteristics Typical of Finnish and the Nordics	87
4.2 The HRM/manager need and performance management reform.....	89
5.0 Desirable Results of the model	96
5.1 The Job Bank/Pooling System/Administrative Class.....	98
5.2 Conclusion.....	99
IV STRUCTURE OF FINNISH PUBLIC ADMINISTRATION	101
1.0 A Historical Brief of the Structure	101
2.0 The Overview of State and Government Structures	102
2.1 The Parliament.....	103
2.2 The Presidency.....	104
2.3 The Government	105
2.4 The Regional and Local Government	107
2.5 Conclusion.....	109
V THE REFORM CASE.....	110
1.0 Introduction	110
1.1 The Finnish Phenomenon and Home of the Reforms.....	110
2.0 The Implementation Strategy of Vision 2012	112
3.0 The change agent or consultant's role	115
3.1 The Role of (Public) Administration in Implementation.....	118
3.2 The System Resource Model	120

4.0 Communication and Implementation Properties.....	121
4.1 <i>Understanding:</i>	124
4.2 <i>Willing:</i>	125
4.3 <i>Capability:</i>	126
4.4 <i>Culture:</i>	127
5.0 Political economy service delivery theory	129
5.1 Conclusion	132
VI COLLECTING AND ANALYZING QUALITATIVE DATA	134
1.1 Introduction.....	134
1.2 The Data Sources	134
2.0 The Reality Construction and Emerging Strategy of the Study.....	137
2.1 Conclusion.....	140
VII - QUALITATIVE ANALYSIS AND FINDINGS.....	142
1.0 Introduction.....	142
2.0 The Strategic Formulators of Vision 2012.....	142
2.1 Finding: The policy lacked guiding theory.....	143
2.2 Finding: Vision 2012 is monobased (civil servants), avoids its environment and disbanded	144
2.3: Conclusion	146
3.0 The Home of Vision 2012 Reform.....	148
3.1 Finding: Vision 2012 information is/was poorly dissemination and not understood.....	148
3.2 Finding: Poor management of the informal and no leadership by example	151
3.3 Finding: No managerial leader and coordination at the Ministry of Finance	153
3.4 Conclusion	155
4.0. Vision 2012 System-wide Implementation Communication.....	156
4. 1 Finding: Poor Communication for Understanding of Vision 2012	157
4.2 Finding: No new top managerial capabilities from Vision 2012 were developed	166
4.3 Finding: Values and Will are neglected in the process	170
4.4 Finding: Culture was never considered at any point in time of the processes	176

4.5 Finding: Management by objective without common minds of Vision 2012	185
4.6 Finding: The Features of Vision 2012 Strategies: Mobility, Coordinating Unit and Fixed term Contracting and Common Central Culture and Pooling System	190
4.7 Finding: The Manager and Managements are Not Commitment to Vision 2012 policy	195
4.8 Conclusion.....	201
5.0 Theory Tests.....	203
5.1: The Brunssen and Olsen models.....	203
5.2 Hasenfeld and Brock's modified theory.....	203
5.3 Value-Will Management Development Model	203
5.4 Theory of the Silo.....	205
VIII DISCUSSION AND CONCLUSION	206
1. Discussion	206
2. Grand Conclusion.....	215
REFERENCE.....	220
APPENDICES.....	233

List of Figures/Tables

Figure 1: Pictorial and structural view of the study	15
Figure 2: Four Worldviews (Creswell 2009; 6)	25
Figure 3: A structure or management unit (example $M_{ABC} + S_A$) consistent with the principles of bureaucracy adapted from Golembiewski (1983; 194)	50
Figure 4: Styles of Managing in terms of Art Craft and Science adapted from Mintzberg (2009)	85
Figure 5: Aspects of performance orientation for public servants adapted from Reichard/PUMA (2002; 4)	93
Figure 6: Basic Values and principle of management in central government, basic roles of top management and the related key competence requirements. Adapted from Ministry of Finance (2003; 16)	95
Figure 7: Organisational Charts of Finnish Public Administration Adapted from the OECD (2009; to the left) & Suomi.fi (2011; to the right)	102
Figure 8: A typical Ministerial structure citing the Ministry of Finance 2012 Model	106
Figure 9: New Regional and Local Government reforms adapted for the Ministry of Finance (2010)	108
Figure 10: Power against interest grid sourced from Eden and Ackermann (1998 in Bryson 2004)	111
Figure 11: Summary of Management Policy and Implementation plan adapted from Ministry of Finance (2003; 41)	114
Figure 12: The System Model Adapted by Vedung (2002; 5) for Government Intervention and Evaluation	..119
Figure 13: Driving Forces and Service Delivery System adopted from Hasenfeld and Brock (1991)	131
Figure 14: A model for analysing Government reform idea by common minds principle of communication	..187
Figure 15: Proposed Value-Will Management Development Model for crafting imbedded in culture plane..	204

List of Tables

Table 1: Brunssen and Olsen (1993) Implementation model.....	113
Table 2: Sampled Organizations/Ministries and numbers Contacted and Interviewed	135
Table 3: Mobility Analysis in the Finnish Public Administration	191

List of Acronyms

DNA	Deoxyribonucleic acid
EC	European Commission
EU	European Union
FLP	Future Leaders Program
FPI	Focus Group Interview
FSA	Funnel Shape Analysis
FSS	Funnel Shape Synthesis
JUG	Joined-up-Government
HAUS	Finnish Institute of Public Management
HR	Human Resources
HRM	Human Resource Management
KELA	The Social Insurance Institution of Finland
KEPA	The Finnish Service Centre for Development Cooperation
MBA	Master of Business Administration
MoF	Ministry of Finance
NPM	New Public Management
OECD	Organisation for Economic and Cooperation Development
USA	United States of America
Vision 2012	Finnish Senior Civil Service Management Development Program/ <i>Towards Professional Management in Central Government: A strategy for management development 2002-2012</i>

I Introduction

Administrative theory's argument is all about efficiency and effectiveness but how to achieve this remains a myth (Simon [1945]; 1997). Public Management and Administrative reforms abound in recent times seeking solutions to their numerous governmental and societal challenges and problems (Peters 2001; Pollitt and Bouckaert 2004). The reform cycle theory triggers are mainly excessiveness and dissolutions (Bardach 2006). For example, Traditional Weberian Public Administration has been attacked and criticised for its excesses, hierarchy and centralisation (Caiden 1994; Meier and Hill 2005). Similarly, the on-going new public management (NPM) reforms are taken on for its over decentralisation, differentiation and eroding of administrative ethos and values (Rhodes 1997; Bozeman 2007; Minogue 2001). Joined up government (JUG) reforms are thought to dominate present thinking involving both academics and practitioners of all sorts of interest groups (Blair 2010; Rhodes 2006; Peters 2006; Pollitt and Bouckaert 2004); perhaps, to put back the broken up pieces from the last dominant NPM reforms in the purported new ubiquitous networks and governance processes (Peters 2001, 2006, 2010; Rhodes 2006; Hill and Hupe 2002).

The instrument of public policy and its choices is common to governments, all other actors and used to influence society and economy (Peters 2010). Traditionally, the policy environment has been conceptualised in three stages namely, the policy formulation and design, implementation and evaluation stages (Vedung 2002; Younis and Davidson 1990). And, Public Administration is the main tool for government policy implementation (Hill and Hupe 2002; Koven 1994). Several arguments since the late 1850s seeking efficient outcomes of government policy inputs have been sighted calling for the separation of neutral civil service implementers from the political decision-makers (Peters 2001, 2010; Civil Service.Gov.Uk 2010; Allison 2008; Hill and Hupe 2002). But while Allison's historical root of public policy analysis observes the difficulty in this separation even for analytic purposes, Hill and Hupe think understanding policy implementation as a legitimate part of the governance process enhances leadership control. Both views may be appropriate but must be based on the implementation skills [and knowledge] of the leader (O'Toole and Hall 2000).

Reform outcomes are mixed of successes and failures (Peters 2001; Pollitt 2003; Pollitt and Bouckaert 2004; Minogue 2001; Christensen 2006). Besides the poor leadership skills and

knowledge, the entire thinking undergirding the reform policy instrument matters (Minogue 2001), as well as its communication. Attempts to derail the set goals are even more than for achieving them (Peters 2010; Bardach 1980). Bardach further demonstrates it is not a smooth sailing affair at goal attainment as several implementation games evolve after the policy instrument is launched. Dunsire (1990) differentiates between policy outcomes as the real world effects from outputs as the civil servant behaviour; finding a gap between them that consequently determines the processes of the positive or negative outcomes.

The approximations of public management reform environmental complexities across borders are driven by socioeconomic forces, political system, elite decision-making and the administrative system (Pollitt and Bouckaert 2004). Agreeably, smart reform policies must be based on feasibility and desirability for efficiency and effectiveness but the NPM reform has failed to achieve that (Christensen 2008). Policy instruments or NPM reforms have been identified from ideological stance and not tested knowledge of effectiveness resulting with fragmentations (Peters 2010; Bozeman 2007; Christensen 2008; Minogue 2001; Rhodes 1997). At post NPM stage, (Christensen 2008; Peters 2006; Rhodes 2006; Pollitt 2003) attempts at taking more control and increased coordination to enhance policy and implementation in the JUG and governance process are visible; but not without the expected NPM managerial and leadership skills (Thiel, Steijn and Allix 2007); having the will to lead and develop (Ministry of Finance 2003); to be backed by the precepts or values of management (Lynn 2003).

The influence mode of communication becomes apparent in organisation process (Drucker 2008; Simon 1997; Mintzberg 1979; 2009); especially for the leadership language (Schein 2004; Pfeffer 1997). Therefore to achieve implementation highest correspondence index (Hasenfeld and Brock 1991) means active communication and participation (EC 2001; Simon 1997; Hill and Hupe 2002). It is the responsibility of the superior to communicate clearly decisions made to the operative for action (Simon 1997). Or the instructions for implementing the reform must be clear (Mountjoy and O'Toole 1979 in Younis and Davidson 1990). These processes enable the operatives to operationalize the reform into their professional working languages for further actions towards success stories (Dunsire 1990).

From this discussion to this point, one cannot disagree with Lynn (2003) that Public Management leadership guided by precepts of management matter and its future belongs to

perspectives such as structure, craft and institutions. But reforms in the Nordic region are civil servant mandarin invention with partial political participation and almost apathetical media (Pollitt and Bouckaert 2004; Pollitt 2003; Brunssen and Olsen 1993). Chritensen (2008) notes such environment has low implementation correspondence index compared to the Westminster Parliamentary systems. This is visible from the OECD (2009/10) two overview reports describe the Finnish Public Administration as silos with independent ministries, departments and agencies. This runs contra to a Finnish Government policy at hand, *Towards Professional Management in Central Government* (MoF 2003). It would then be interesting to understand such dynamics and politics taking on this reform policy for its managerial development and how it has been communicated for implementation with the object of seeking centralisation and common culture.

This process study unfold below in the order of this introductory chapter outlining what is to be the focus of the study from global perspective to the Finnish manager specific. This is followed by the chapter II: Basic Choices of the study where the statement problem and research questions are deduced; the study goal and the point of view are stated and discussed. Chapter III Features the Conceptual and Theoretical Framework: a mix and blend of theory with practical and historical related development for in-depth meaning and understanding of the nature of management and Implementation Communication. Next, chapter IV is the introduction of the Structure of the Finnish Public Administration revealing its unique Finnish phenomenon. Chapter V is The Reform Case as well as justifying the study's own Implementation Communication concept and study scope. While chapter six goes for Collecting and Analysing Qualitative Data chapter VII takes on Qualitative Analysis. Chapter VIII represents Discussion and Grand Conclusion. Figure 1 below shows the wholistic structural view of the study.

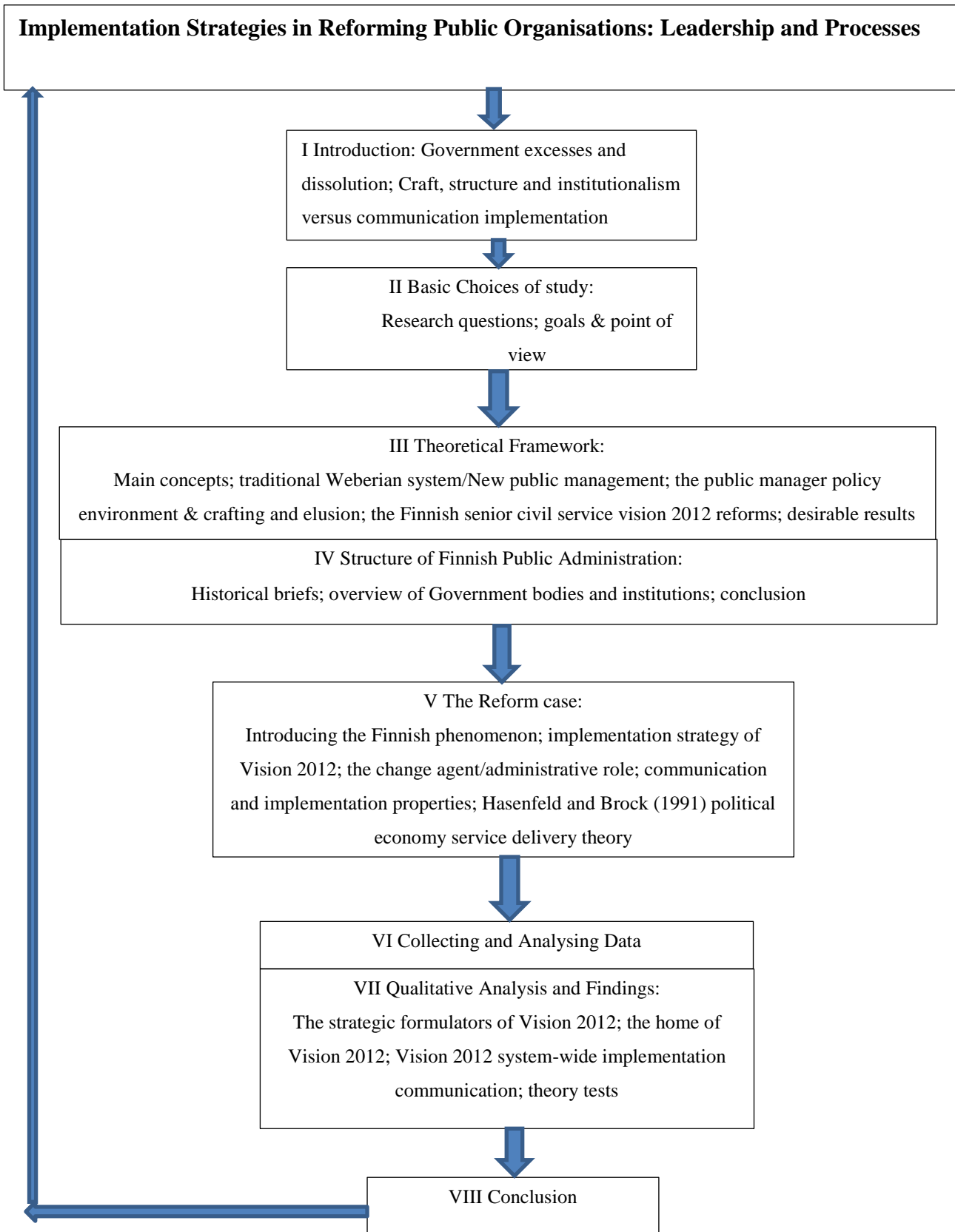

Figure 1: Pictorial and structural view of the study

II Basic Choices of the Study

1. Setting the main question

At the behest of the Finnish Government the OECD (2009; 2010) has twice ascertained what could be described as the present realities and myths of the state of the Finnish Public Administration. This was in preparedness for the Katainen Government for its own efficiency and effectiveness, and to citizens as well as its businesses [including its third sector that depends on government]. Its findings, conclusions and recommendations relevant to this study are therefore taken seriously. Following from the reforms Finland can bluff of a strong (OECD 2009) and modernized public sector (Haapala 2009). However, the OECD further dissects this strength: First, due to the coalition type of government the ministries are shared and turfs well managed and protected leading to the construction of vertical silos/stove-pipes. Second, reforms from the vertical silos are legislative (hard/strong tools) dependent and that works well for the existing practices. This coalition practices promote no implementation effectiveness (Christensen 2008).

Now, pertaining to this study is the issue of being silos as a result; and, characterised by horizontality, individualism against centralisation, communication difficulties [consistent with Pollitt and Bouckaert (2004)]. Importantly, to note is the OECDs recommendation that abandons any attempt at connecting these fragments. These run contrary to the study input's objective of having a wholistic central government imbued with "commit[ment] to a common management culture" (MoF 2003; iii). That is, frustrating communication with a common language (Senge 2006) and its free flow.

Organisational communication as the chief mode of influence is the study view. The philosophy is that a well communicated strategy is better implementation for best desirable results. The inspirational sources are two: One from Drucker ([1974]; 2008) that the structure of organisational establishment must be based on communication and the individual; to the other, communication unbounds the rational individual for better performance (Simon [1945] 1997). Considering, for example, the picks from the overviews it is consistent with, normal expectations of organisational actors (including all other people) to look up to the organisation apex for jobs, actions and directions, and all that (Golembiewski 1983) leaving out the not normal as horizontality. Under such normal organisational process Brunssen and

Olsen (1993) assert that when the organisation's uncoordinated tasks and activities are grown to insurmountable heights then it may then become a noticeable problem which then draws attention to (another mode of influence) authority calling for reform. By communication and coordination these matters are resolved (Drucker 2008; Simon 1997; Mintzberg 1979; Brunsen and Olsen 1993); implying poor communication and coordination is a key source of expensive and time consuming organisation reform. In addition, this vertical practice mention above neglects the not normal horizontal tasks and, may also favour and promote the top-down implementation model; which emphasizes hierarchical control inherent with difficulty of policy modification and distortion by implementers (Younis and Davis 1990).

But generally observed, horizontality is become the major problem of governments, and furthered by the adoption of the new public management (NPM) reforms (Peters 2006); of which the Finnish system models (Pollitt and Bouckaert 2004). Horizontality management in Finland may not be new as the Government Ministerial Paper *Central Government Reforms* (Ministry of Finance – MoF - 2002) demonstrates. With the understanding that leading and implementing processes have been observed to be characterised by intra-organisational and inter-organisational behaviour based on commitment and coordination (Winter 2006; Mintzberg 2009) or as a joint activity (Pressman and Wildavsky 1984) fails to blossom in this sort of environment. Communication for implementation difficulty has been sighted in the Finnish private sector too (Aaltonen and Ikävalko 2002). Consciously or not, those ideologies and practices seen above lack innovativeness; but may nurture its silos' survival and growth as the OECD observes while injuring the overall health of the organisation (Drucker 2008).

In an organisation/institution the law, rules and regulation as well as other documents turn to be a form of communication and behaviour expectations (Simon 1997). Bardach (1980) demonstrates by his Implementation Game Theory that after the law (or policy) is enacted starts the numerous games, dissipation of entropies and massive resistance to deflect or stall program goals and activities. Laws by themselves, therefore, are not enough for policy and program implementation but a Finnish system better believe (OECD 2009); which unfortunately gets recommended over soft tools in their second review (OECD 2010). Soft ways or talking and convincing means without the use of law and its accessories are preferable (Pfeffer 1997; Kotter 1996). For example, in the Herbert Simon view of successful organisation may pave the better alternative: "Willingness of employees at all levels to assume responsibility for producing results – not simply following the rules – is generally

believed to be a major determinant of organizational success” (Simon 1991, 37 in Pfeffer 1997; 116).

A further dissection of the OECD (2009) communication difficulty is necessary. Circumstantially, the political decision-maker is cut off at the top silo-slab: “All the information from bottom-up does not always reach the central development actors, but stays in the administrative field” (OECD 2009; 31). The subsequent report accounts for and describes the silo situation by borrowing and literary using the phrase “separation of powers” at the ministerial apex (OECD 2010; 19). However, silos and their corresponding slabs are not only Finnish phenomenon but a modern organisation feature where managers hang in stacked, staved off the necessary information, power and purposive links for action (Mintzberg 2009; Hanson 2009). All put together characterise the silo features that frustrates communication and centralisation practices that in turn affects decisions, implementation and qualitative results of reforms and managing.

From such background, it is obvious a decade of implementing the senior management development reform shift towards professionalism (MoF 2003) appears stale as the OECD (2010) recommends to the Finnish Government abandonment and shift in focus of the reforms. Hitherto, the Finnish Public Management was thought to be collegial and consensus but has since slip away to the opposite end of individualistic and independence continuum (Finnish Literature Society 1997; Tiihonen 2001; OECD 2009; 2010). The concern is how come this slippage; it could be a very important source of the problem affecting the entire policy cycle processes. Described as silo system devoid of free and open communication and coordination; yet, the preliminary evaluation of the ten-year staleness for ‘professionalism’ management claims it is on course although short of robustness (MoF 2011). This could be misinformation and misleading to decision makers as the Finnish Government Manager Communication Problem among others has not been identified in the Government vision for Senior Civil Servants Management Development Program (MoF 2003); or even the OECD (2009; 2010) reviews which identify but fail to deal with it; just as many other public and private managerial problems remain unidentified let alone solved (Dingwell and Strangleman 2005), especially, when all points to economic and bonuses as well some external forces (Pfeffer 1997; Mintzberg 2009; Stiglitz 2009; Galbreith 2004).

Communication is a necessary ingredient and mode of influence necessary for any organisation development that cannot be ignored (Simon 1997; Drucker 2008; Hackman and Johnson 2009; Mintzberg 1979; 2009). Yet, the OECD did conspicuously in the following graft to support its recommendation: “the reforms seek to strengthen the existing system.... Shifting the current paradigm could be achieved by turning the public administration on its head, by changing its focus from better connecting ministerial stove-pipes and local government boundaries to focusing work around the needs of its citizens and businesses. ... It requires coherent service delivery ... whole-of-government perspective, stronger horizontal linkages across state government and reinforced capacity and leadership at all levels of government to better communicate and implement a common vision” (OECD 2010; 33-34). It is an unfinished job with an abrupt end. It must be done and completed; and, this study is doing just that. The Finnish Prime Minister’s Office (2010) review of the 2002 Government Communication document targeted the media [that is antireform or reform apathetic (Pollitt and Bouckaert 2004)] in the policy process neglecting its own internal communication machinery. The most bizarre is the lack of communication implementation plan to match the Management Development implementation.

Not surprisingly the case, it is recorded that: “Despite the importance of information and communications as mediators and the determinants of innovation process few studies have focused on either” (Loveless and Bozeman 1983; 401). Communication is a tool used by managers to achieve their goals (Hackman and Johnson 2009); especially in reform situation and for its special language (Pfeffer 1997; Pettigrew, Ferlie and Mckee 1992), and both internal and external interactions with the environment (Loveless and Bozeman 1983). The manager’s job is by and large communicating (Yukl 2010; Mintzberg 2009; Hackman and Johnson 2009), as an initiator, advocate, ratifier and acceptor (Loveless and Bozeman 1983). Communication is a two-way process defined as any process whereby decisional premises are transmitted from one member of an organisation to another (Simon 1997; 208). Mintzberg (2009) demonstrated the delinked and deactivated silo effects bogging down the manager contradict the manager’s well connected position being the active centre of information and communication of the organisation. Furthermore, Manager Bernard’s experience and writing has since 1938 demonstrated the need for a system of communication as a priority of the executive (Shafritz and Russell 2003; Lynn 2003; Mintzberg 2009). Mintzberg then asserts the manager is the chief information source of the organisation communicating all around.

Despite all these manager communication needs, studies outcomes show that traditional Weberian centralised bureaucratic excesses starves the manager (Caiden 1994; Meier and Hill 2007); and most recently, the NPM/HRM reforms practices not only starves but encourages differentiation and impedes implementation while overlooking context as well (Taylor 2001). This blurs and weakens the process of face-to-face quality discursive policy cycle (Habermas 2008). Policies are mostly ambiguous instruments and even where it is of high quality it does not implement itself but require effective communication among actors for implementation (Pollitt and Bouckaert 2004; Lynn 2003). In the same vain, evaluators would require to know something about implementation to understand and place value judgement (Vedung 2002; Patton 2002) making the process knowledge and monitoring relevant. Patton observes that with knowledge of the implementation a prediction of success or failure is possible at any time. Hence the need to start understanding the process from basics with Implementation Communication as the core; for it is implementation that shapes policy (Pressman and Wildavsky 1984) and its outputs and outcomes.

Younis and Davidson interestingly, discussed what they called a brief survey of the core approaches to policy implementation with the view to contributing to its theory. Notably but regrettably, they have outlined the three models of implementation as follows: prescription for success – the top-bottom approach; a radical change – the bottom-top approach; and Implementation as Evolution. In their discussion Hood's (1976) perfect Administration and Gunn's (1980) follow up analysis of the theory were raised; also was the Mountjoy and O'Toole (1979) theory of policy implementation which determines effective implementation via resource provision and the specificity of instructions. Yet, the concept of communication and coordination between the units of the administration failed to find place in their discussion; their emphasis and conclusive message fell on placing mere weights on the three models (Younis and Davidson 1990). But this study holds that be it top-down, bottom-up, evolutionary or even governance or JUG (Blair 2010; Peters 2010, 2006; Rhodes 2006) its effectiveness is communication implementation based.

Similarly, did Crawford Morgan (1990) recommend Hood's perfect administration theory for the analysis of any policy implementation. However, his emphasis fell on adequate resources and unbound timing rather than the core communication and coordination to the detriment of implementation literature that it seeks to enrich. Moreso, when Hill and Hupe (2002) had identified with views of Goggin and O'Toole's model of communication for implementation

and blended communication generally into policy implementation legitimising it as an integral part of the governance process. Furthermore, Mountjoy and O'Toole found out about adequate resources while their emphasis fell on communicating the instructions for clarity and desired direction.

The uniqueness of communication over all the others is that face-to-face communication of discursive quality for understanding and action (Habermas 1984; 2008; Brunsen 2008; Simon 1997). In implementation literature that mostly cited since 1887 is the recognition of the dichotomy between policy and implementation (example, Hill and Hupe 2002; Allison 2008). In recent times and, following the break through with Implementation studies in the early 1970s with Pressman and Wildavsky's (1973): *Implementation*. The success of implementation has come to be the achievement of objectives or problem solved (Winter 2006) which may depend on any or several of the implementation barriers including economic and communication (Holbeche 2006; Altonen and Ikävalko 2002; Al-Ghamdi 1998) and, more importantly, the implementation properties – understand, will, capability (Vedung 2002; Lundquist 1989). Vedung even extends this to engulf the entire administrative facility as 'administrative willingness' facilitating the implementation process; yet they failed to connect these to communication tool and processes. Combining the Drucker communication and individuality and Simon's variable bounded rationality, the study argues that communication of reforms must not be for its own sake as observed so far but needs to be defined and standardised.

For instance, Dingwell and Strangleman (2005) observe in the 1980s reforming managers in the private sector to be vocabulary change and a failure to identify the managerial needs and tool alignments. Rather, the implementation properties of the reform must align the reform policy contents to define the communication for desirable results. In that perspective, the variability by information, knowledge and skill well communicated for understanding, capability development enhances the will of the individual's confidence level for effective action rather than external surveillance (Pfeffer 1997) which should play complementary role. Importantly, it is the duty of the decision-maker to communicate this to the operative for action desired (Simon 1997).

In another development but still taking it from the decision maker level, Dunsire observes for policy implementation to begin there is the need for its operationalization, a terminology

acknowledged and borrowed from philosophy of science; in this process the different professional or functional groups decipher and translate this policy language inputs into their own for understanding requiring effective communication from policy sources. He observed the principles of communication in the vertical plane of bureaucracy although it remains unchanged but legislative/political talk at the top differs from that of the middle and lower operational levels' vocabulary and styles. The more remote a department/unit is from the top the more the need for interpreters or translators (Dunsire 1990). Hence the effective communication need.

A case in point is Bardach's reportage of a 1967 classic study of a newly appointed district director of Bureau of Education Change who wrote and presented to the teachers his innovative ideas of catalytic teaching roles and self-learning motivations of pupils. What is described as genuine implementation problems were found to include the design and communication of the model. The teachers were found to have very little talk about the model and the director never found communicating further on his own writing: "He wrote up his description and assumptions for the catalytic role model, but there was no communication after that." As to the "highly motivating self-instructional materials" the teachers did not know what they were, did not know how to create them and were not given any. "[T]he type of materials teachers needed did not exist" for the innovation yet the administration demanded implementation. As the reformer never granted any advice on his innovation the demoralised teachers believed he lacked the experience and did not even understand his own philosophy (Bardach 1980; 171-2). In-depth, the study goes to depict that making a policy does not automatically make one comprehend and, therefore, able to articulate it in communication for implementation. The assumption is self-reflection for understanding and communication articulation of a policy is a necessity for implementation sharing and success.

Back to a local circumstance, a not farfetched example is Finnish Nokia. It is an over centenary old organisation and in recent times dominating the World communications industry, yet it lacked internal communication until 2006 (Hakkarainen 2009), although not a reform; and this, could even be part of its current crisis. These suggest the problem of organisational communication may be more of cultural than any other thing in the Finnish society and for that reason cannot be taken for granted as the OECD overviews did. It is important to note the last sentence of the quotation which coincidentally identifies partially with this study as: ... "reinforced capacity and leadership at all levels of government to better communicate

and implement a common vision” (OECD 2010; 34). But the review fails in getting to the source of the problem which is the other most important part of the study. How this fits in becomes a matter of concern and must be worked at and understood why the system remains a silo-slab after a decade of implementing Finnish Government *Towards Professional Management in Central Government* (MoF 2003). In that case, reforming management for commitment and performance, need be to understand the nature and processes of the Finnish top management and administration and its processes by asking: 1) How potent is the Finnish Senior Management Development Program, and 2) how has its **Implementation Communication** [via implementation properties] been conducted for implementation?

2. Setting scientific and practical goal for the study

The response to the study question posed is to understand the nature and practices that led to the alleged Finnish silo system construction and maintenance having for a decade (2002/3 to 2012) sought for centralisation and common culture in government. In such an attempt, both Marshall and Rossman (2006) and Patton (2002) assert a lookout for patterns related to the phenomenon in question and, to also identify plausible relationship such as attitudes, behaviours or any forces of interaction shaping the phenomenon. Therefore, following from the literature on public management and administration picking on crafting, structure and institutional development (Lynn 2003) selected to guide analysis and synthesis of this Implementation Communication process hence positing the following goals:

2.1 Scientific goal: From then new perspective of public management the study would be contributing to management development by structural, crafting and institutional processes; as well as boosting the legitimacy of implementation in the governance process with the innovative Implementation Communication developed by this study. Furthermore, as implementation analysts contend among themselves at the highest levels with the three models and as to whether implementation studies should be taken from the top-down or the bottom, goal achievement or problem solving or even single or double case studies with several data sources or even diversity versus unification (Winter 2006). This study’s contribution to implementation theory tend to be modest thus from the lowest level; and, begins with the very fundamental basics, an imbued Implementation Communication reform contents that equips the individual-self-understanding, builds capability and develops the will for policy implementation and desirable results production.

2.2 To justify the contextuality in implementation by suggesting parsimoniously standard conduit properties for implementation communication – understand, capability, will and culture. Culture is incorporated into the properties of implementation as hinted from the Nokia example. It is to assess what of it was/is communicated in the on-going process. Much is found in literature but often culture is neglected in organisational studies (Pfeffer 1997; Kickert 1997; Pfeffer and Salancik 2002; Fukuyama 2005) or where it is in use it is mechanistic (Morgan 2006). In varied terminology terms while some qualitative methodologists (Marshall et al. 2006; Patton 2002) warns about the context and culture others (Peters 2001) speak of settings. With all these funfairs no study of implementation of the sort on culture has been cited in the course of this study. However, advanced arguments (Pollitt and Bouckaert 2004) show Japan borrowed some Western management and reform ideas and, the ability to adapt these to their culture is their success (Mintzberg 2009; Morgan's 2006; Fukuyama 2005). Again, Mintzberg points out that the culture process is collective; and, as a form of control, culture is decision shaping as a form of leading and the manager is the energy centre of the organisation making it necessary for consideration.

2.3 Practical goal: It is clear to this point that both the OECD (2009/10) reviews and the Ministry of Finance (2011) evaluators of the policy under review have totally two diverse views: respectively, the Finnish Government is to avoid all attempts at unifying the silos and, the management development program is on course and requiring rigor. It is, therefore, the study goal to clarify the situation; thereby contributing to the Finnish management development and its processes and generally to knowledge in this field.

2.4 To (specifically) establish the integrated and or centralised approach in the management development and its implementation processes. Usually, organizational studies is broken into two parallels, namely, content of change and process of change missing out on the necessary interaction between them (Barnett & Carroll 1995 in Pfeffer 1997, 202). To bridge such a hiatus the study questions the Vision 2012 policy for its potency from the contents on the one hand; on the other, the communications for implementation practices in use from the set plan to enhance manager development. In addition to his (Pfeffer) acknowledgement of the rareness of connections among topics and test of competing perspectives, this study seeks to pursue such a multi directional or interdisciplinary perspective mixing and blending theory, history/practice, culture and all possible relevant fields for better explanatory and understanding.

3 Setting out the main point of view of the study

This study justifies its research strategy as being qualitative brand, case study and interviewing technique encapsulated in the worldview of interpretivism/constructivism. This capsule of ‘worldview’ according to Guba (1990; in Creswell 2009; 6) “is a basic set of beliefs that guides action.” To Creswell, these influences to the researcher come from the general world orientations and subject area among others. Burrell and Morgan (1982) argue that to the individual, it provides a convenient way of locating one’s own personal frame of reference with regard to social theory; thus, a means of understanding why certain theories and perspectives may have more personal appeal than others.

In most cases social science tools for mapping intellectual journeys are provided in four paradigms/worldviews/philosophies which are mutually exclusive but offer alternative views of social reality. Understanding the four distinct paradigms implies understanding the four different views of society and different ways of seeing (Burrell and Morgan 1982; Creswell 2009; Patton 2002). Burrell and Morgan illustrate further that the different ontology, epistemology and models of human nature are likely to incline social scientists towards different methodology.

Postpositivism	Constructivism
<ul style="list-style-type: none"> • Determination • Reductionism • Empirical observation And measurement • Theory verification 	<ul style="list-style-type: none"> • Understanding • Multiple participant meanings • Social and historical construction • Theory generation
Advocacy/Participatory	Pragmatism
<ul style="list-style-type: none"> • Political • Empowerment Issue-oriented • Collaborative • Change-oriented 	<ul style="list-style-type: none"> • Consequence of actions • Problem-centred • Pluralistic • Real world practice oriented

Figure 2: Four Worldviews (Creswell 2009; 6)

The four sociological paradigms, each generates its own distinctive analyses of social life and they are based on different sets of metatheoretical assumptions about the nature of social science and the nature of society – Figure 2 above. Myers (2009) evinces that all theories of organization are based upon a philosophy of science and theory of society; underscoring the validity, scope and its methods.

In postmodern philosophical parlance for the paradigms are: postpositivism, constructivism, and advocacy/participatory as well as pragmatism (Creswell 2009; 6; Figure 2 above). An important observation is that the radical structuralism/pragmatism refused to be quarantined by any one particular worldview and in reality runs through all the other sections. The second quadrant is the worldview of interpretivism/constructivism where this study finds a home as its characteristics suits the purpose and goals of the study as the listings depict alongside real world practice and the rest of pragmatism.

Bryant and Charmaz (2007) explain the terms positivism and constructivism. Positivism is “an epistemology that subscribes to a unitary scientific method consisting of objective systematic observation and experimentation in an external world (pp. 609).” Positivist inquiry goal is to discover and to establish general laws that explain the phenomenon under study; and predictions made possible; as a consequence, experimentation and prediction can lead to scientific control over such phenomenon under investigation. Constructivism addresses how realities are made: It “assumes that people, including researchers, construct the realities in which they participate (pp. 607)” and the inquiry starts with the experience while asking how members construct it; to the best of their ability, constructivist enter the phenomenon, gain multiple views of it, and locate it in its web of connections and constraints; admittedly, the interpretation of the studied phenomenon as done here itself is a construction of, the output or the implementer behaviour (Winter 2006).

Also found on the continuum is the qualitative-quantitative research methodologies. Creswell approaches to inquiry/strategies are of three designs namely, qualitative (statement problem, research question), or quantitative (hypothesis, objectives) or mixed methods (statement problem, research question, hypothesis, objectives) approach. Features of research question/statement problem bring up this study to qualitative inquiry where social constructivists/interpretists seek to understand the world in which they live and work (Marshall and Rossman 2006; Creswell 2009; Patton 2002); particularly, being a process study (Loveless and Bozeman 1983; Patton 2002).

Largely and notably, the unlikeness of the opposite divide, post positivism is involved with artificial manipulations of situations –quasi experimental- but qualitative tradition is in its natural settings of laboratory (Patton 2002; Myers 2009). Whereas Patton points to several (18) genres emerging of this qualitative tradition; Myers talks of three based on the underlying philosophy: positivist, interpretive and critical; arguing that in management researches the dominant being positivism while the least, critical. Probably, along the lines of Bryant and Charmaz (2007) and Figure 2 above, Myers explains that positivism is the use of natural science tools in social science to objectively study social phenomenon, formulating propositions, show subject matter as independent and dependent variables, the relationship between them, hypothesis tested, and people treated as objects; often at the end demanding one correct and objective meaning contrary to the qualitative hermeneutical and postmodern thinking that make way for legitimate plurality of interpretations (Kvale and Brinkmann 2009).

Moreover, this study fail to offer itself for such an objective or quantitative study as its numbers are far below what is proclaimed feasible. Ragin (2007) cites a threshold number of cases, $N = 30$ to 50 as minimum. This study is dealing with less than a quarter of the total of Pollitt and Bouckaert's (2004) total of 200 Finnish Government managers. For example, there are 19 ministers and 12 permanent secretaries sourcing from the prime minister's website. Taking surveys for instance, Schein (2004) argues how to measure cultural artefacts when you do not even know what to question about.

Furthermore, Myers argued both interpretive and critical research are similar in many aspects, as for example, they share the double hermeneutics principle; that is to say, social research stands in a subject-subject relation to its field of study. Critical research is a social critique and assumes social reality is historical; people can therefore act to change their economic, sociocultural and political situation; there are dominant interpretations of the situation in any society; the job of critical research is, therefore, to throw light on restrictive and alienating conditions such as those preventing enlightenment, justice, and freedom etcetera (Myers 2009). Kvale and Brinkman (2009) also observe that while phenomenology deals with how humans experience life world phenomenon hermeneutics charts interpretations of meaning, and discourse analysis attention is how language and discursive practices construct the social

world of humans. Although plausible sounding of critical and phenomenology, the study choice is hermeneutics/interpretive/constructivism of the Finnish Ministerial apex.

Interpretive research tends to focus on meaning in context and its raw data includes words meaningful to or pre-structured by a people (Myers 2009). Following its tenets, Hermeneutic theory posits that one can only interpret the meaning of something from some perspective, a certain stand point, a praxis, or a situational context, whether one is reporting on one's own findings or reporting the perspectives of people being studied - and thus reporting their stand point or perspective - (Patton 2002; 115). So the guiding principles for this analysis and synthesis emanates from the advance interpretation of hermeneutics inquiry and analysis as follows from Kneller (1984 in Patton 2002; 114 - 115):

- “Interpreting text is synonymous to a human act or product and as in all learning,
- All interpretations do happen within a tradition,
- Interpretation involves opening one's self to a text or its analogue as well as questioning it, and
- Interpreting text in the light of one's situation.”

These principles are consistent with contextual issues such as management (Mintzberg 2009); Values and institutions (Bozeman 2007; Lynn 2003); reforms interpretation (Peters 2001); cultural (Fukuyama 2005; Morgan 2006; Calhoun and Sennett 2007) and, of course, the Finnish Management Development (MoF 2003) and processes (Loveless and Bozeman 1983) construction. In this context the study goes with the designated policy target as the government top level ministerial manager interpreted to be permanent secretaries, permanent under-secretaries and director-generals. It did, however, take the entire policy environment into consideration such as the political masters and other lateral colleagues or stakeholders and the governed.

The technique adopted is, qualitative research interview craft, a knowledge producing activity and a social practice; noticing although the term “interview” came into use in the 17th century but conversational ways of eliciting systematic knowledge had existed long ago citing Greek civilisation (Kvale and Brinkmann 2009). In recent times, despite qualitative methods suiting implementation research (Patton 2002; Weiss 1998); calls are made for mixed research or inclusion of statistics (Winter 2006). Patton (2002) had earlier argued both methods complement process and outcome evaluations. As such, the study adopts bricolage: a mixed technique of discourses allowing for free movement between techniques and concepts (Kvale and Brinkmann 2009); for coherence, comprehension and wholeness. The unit of analysis is the processes and individual; thus top civil servant or government manager.

III Conceptual and Theoretical Framework

1. Main Concepts

“Governance’ means rules, processes and behaviour that affect the way in which powers are exercised at European level, particularly as regards openness, participation, accountability, effectiveness and coherence” (pp. 8). Extensively, a “more coherent Union will be stronger at home and a better leader in the world” (European Commission –EC- 2001; 3). Befitting this ambitious definition: “Ruling is an assertion of the will, an attempt to exercise control, to shape the world”; this ambition of the state officials is pursued by the instruments of public policy (Goodin, Rein and Moran 2006; 3). The case in focus is the Finnish Government’s (MoF 2003) instrument: *Towards Professional Management in Central Government: A strategy for management development 2002-2012* – theory of action. The object of the model is to inculcate “values” backing the “will to lead and develop” the Finnish public officials/managers (pp. 16) and Finland.

With almost a decade of implementation of this instrument as hinted in the last chapter it was observed that the OECD (2009; 2010) overviews described the system as siloic public administration where the structures are independent ministries, departments and agencies with siloic-based thinking, siloic policies and siloic implementation (OECD 2010; 15). Thenceforth, Governance, particularly in Finland is a scarce commodity and presents a challenge to the individual whose choice of career is its pursuit (Peters 2001).

“Public will or public interests” (Lynn 2005; 31) and public values and institutions (Bozeman 2007; Lynn 2003; Selznick 1957) are basic drivers of public management and administration. Will and value have the propensity to drive the individual’s action (Bozeman 2007; Pollitt 2003; Olivecrona [1939]; 1971). Also, recent developments bring upon the government manager the challenge of creating best public value (Moore 1995) or using less to generate more (Peters 2001; Kickert 1997) for the citizenry. Peters asserts although being creative and persistent in this pursuance the philosophers’ stone that will produce good government remains elusive as they continue to design new instruments for governing. However, public sector organisational inventions geared towards service delivery and implementation lacks research sources besides its traditional research and development laboratories (Loveless and Bozeman 1983) which does not automatically feed into it as observed in Finland where the politics are not Think Tanks and or Tertiary Institutions backed (OECD 2010). The Finnish Government policy (MoF 2003) under investigation is a self-invention or attempt at

innovation. Mohr defines innovation as “*the successful introduction into an applied situation of means or ends that are new to that situation*”. And for his clarification: Invention implies bringing something new into being while innovation implies bringing something new into use. In the organizational world this distinction is necessary as the argument is whether an organization can create something new for its own use or for exploitation by others, or whether it can successfully adopt goals or policies or processes that are new in the sense of being departures from its own tradition (Mohr 1969; 112).

Similarly, but from different perspective culture is viewed as an achievement through practice in a range of specific occupational fields and lifestyle niches by making, remaking in nearly subtle small creative ways as well as occasional large burst of innovations (Calhoun and Sennett 2007). The public manager has no monopoly over organisational culture (Morgan 2006); but can influence innovation processes via awareness, matching, redefining, restructuring and interconnecting (Loveless and Bozeman 1983). “Process” is about the way of talking about the common action that cuts across program activities, observed interactions and program content (Patton 2002; 474). Loveless and Bozeman probably hold a broader view that organisational processes are an umbrella for both the pattern of informal social relations and pattern of communication within the organisation and between the organisation and its environment (pp. 400); the interaction, negotiation and bargaining among participants [to Bardach (1980) means control] in the process of adopting, modifying or rejecting the reform generates the raw material of political analysis; while those people with deeply held values would bear out conflicts (Loveless and Bozeman 1983).

Lynn affirms action-oriented and behavioural approach to the new public management. Expanding his view by two perspectives as: traditionally being a responsibility for discretion exercise and lately the craft perspective. The latter thus being a matter for decision, actions and outcomes as well as the necessary political skills required for particular role in managing. Further emphasis is put to political strategic managerial roles “*within given political and institutional settings*, the newer conception is concerned more with the immediate, pragmatic concerns of managers at executive levels of governmental organisations”. In conclusion he argues that the two perspectives provide the structural, craft and institutional fundamental elements of public administration and management; these elements in turn demand practice must conform to constitutional structures and values; thereby, setting the analytic framework for particular management reform proposals and developments (Lynn 2003; 27). Therefore,

to understand and determine how the Finnish Constitutional (1999/2007) requirements are fulfilled of the instrument under study its structural, craft and institutional implications are sought for. The inventions and innovations mostly are adoption from elsewhere but an adaptation of a particular locality (Sennett 2008) or “different national settings” (Peters 2001; x). This marks the first implementation challenge of localisation.

Lightfoot (1997 in Patton 2002; 63) defines: “By context I mean the setting – physical, geographic, temporal, historical, cultural, aesthetic - within which action takes place. Context becomes the framework, the reference point, the map, the ecological sphere; it is used to place people and action in time and space and as a resource for understanding what they say and do. The context is rich in clues for interpreting the experience for the actors in the setting. We have no idea how to decipher or decode an action unless we see it embedded in context (p. 41)”. Contextually, therefore, this study deciphers or decodes the picturesque of a “silo” pejorative in organisation. Mintzberg (2009; 169) describes silo as “vertical cleavages running up and down the hierarchy that separates functions from each other” and the other being “horizontal in nature that separates hierarchical levels from each other” called “slabs” because they are “often isolated layers of managerial activity, one upon the other ever more abstract from the operating realities”.

Mintzberg’s concern is that “when these hierarchical slabs become especially thick, often the case in machine organisations, the Quandary of connecting can take the organisation into strategic gridlock: layers of managers sit in their own no man’s land, each one lacking the information or the power necessary to connect adequately to the others.” He observes the most problem of this conundrum is at the apex rather than the bottom and deviates from Peters and Waterman’s “management by walking around” to “management by just ‘being there’ based on trust” (Mintzberg 2009; 170).

Drawing from ideas of Scott that both context and organisation influence affect each other but the latter respond readily to external forces more sensitive to its survival; thus context refers to all the external factors that exists outside the boundary of the organisation or ‘system’ and have the potential to affect and shape formal work organisations and in turn influences Human Resource Management strategy, policies and practices (Bratton 2003; 77). Clarity sets in following the contextual silo decoding at the description of the Finnish politico-administration acting from siloic thinking through to siloic implementation and evaluation of issues (OECD 2009; 2010); contrary to the democratic model and present

witnessing of the emergence of a highly interdependent world society with functions permeating national borders and requiring coordination, regulation and networking of the national framework (Habermas 2008).

This means understanding the concept of implementation and its context matters. From constitutional governance and politico-administrative-societal relations perspective vis-à-vis the task of designing institutions, implementation is that part of governance that involves activities in relation to public tasks that follow the legitimate, directive decisions on those tasks, with its scope falling between what happens between policy expectations and perceived policy results (Hill and Hupe 2002). Its processes include 1) assembling the elements required to produce a particular programmatic outcome, and 2) the playing out of a number of loosely interrelated games whereby these elements are withheld from or delivered to the program assembly process on particular terms (Bardach 1980; 57-8). Opposite to the silo decoded revelations where managers are stuck, starved off necessary information and power to act; all these latter align with Lynn's (2003) earlier requirement of active public management whereby the managerial political roles or crafting are brought to yield better decision, action and outcome.

Problem exploration determinants of innovation variant are identified as the attributes of the reforms, attributes of the public organisations and its membership, and attributes of the organisations' environment (Loveless and Bozeman 1983). Modern organisations and their environments are thought to be of silo oriented (Mintzberg 2009; Hanson 2009) especially modelling the NPM reforms (Peters 2006). Such problematic deviant results are understood better via the Institutional Approach (Brunssen and Olsen 1993; Rhodes 1997).

1.1 The Finnish Environment and Institutional Approach

Brunssen and Olsen argue, both organizations and their environments are institutionalizable in analysing administrative reforms. They recognized that formal organizations and their environments are often institutionalized to imply "ways of thinking and acting are governed by culturally determined rules". Being institutionalized means having many of the rules of individual organizations being part of the wider rule-system in society (Brunssen and Olsen 1993; 12). Just as values flow from society to and from politico-administration systems

(Tiihonen 2001; 2004). Or put another way organisations are created from society with new rules of their own. Brunssen and Olsen (1993) observe further that a well-developed institution generates capacity for action, facilitates effective coordination and at the same time generates inertia in the phase of attempted reform, a phenomenon well established in political theory. The institutional subject matter embodies the rules, procedures and formal organizations of government and its network analysis using the tool of law and history to explain the constraints of both political and democratic effectiveness termed the institutional approach (Rhodes 1997).

This research explores the question of how these institutional factors in addition to theory affect change processes and attempt at reform to understand the [silo] organizational inertia. It is also necessary to analyse the interaction of the intention of the reformers, organizational structures and transformation in society and their stance makes this possible (Brunssen and Olsen 1993). The effect of institutional context or interference with reforms is an act of examining the institutional origins (Homberg et al. 2007).

1.2 Organizational Culture and Historic Analysis of Finland

A turn to another angle of history and culture of the Finnish society to blend the above discussion for meaning is necessary for institutional purposes. This is anchored from Dingwall and Strangleman cultural analysis contend from Beattie (1966; 13) and Goodenough (1957) respectively: ‘No account of a social relationship in human terms can be complete unless it includes reference to what it means to the people who have it’, and that culture exist in minds of people who in turn assigned meaning to physical material artefacts of their environment. To the new institutionalists, organizations have two mutual trends as formal and informal. While the formal is governed by rationality [new organisation rules], the other, culture [Brunssen and Olsen’s wider rule system or institutionalisation; see above].

Selznick warns of a sound management practice required to arrest and control these internal social pressures of the informal side of the organization; that the internal social world is never accounting for by the formal. The people of the organisation have their own needs for self-fulfilment and protection that may affect the formal system either positively or negatively; work over flows defined boundaries; this people relation are a potential of energy that could be put to constructive use else they are transformed into recalcitrant source of frustration.

People draw from the formal system to boost their personal or group egotism while using the position to satisfy psychological needs; this may also be positive or negative depending on how the organizational goals are accepted by the people (Selznick 1957; Glombieweski 1983). The specialised outfit group may turn into a social group some newly expendable energy is created with divisive and frustrating potentialities. The rivalry may generate a powerful force as it is able to put together the individual egotism and tie it to group goals. This force could be a dangerous threat to the unity of the entire organization (Selznick 1957).

Dingwall and Strangleman (2005) and other researchers found that the cultural basis of all organizations forms the structure and actions; as well, organizational boundaries being open and fluid. This allows cultural foundations of action to be permitted with the organization and at the same time reflects the organization's interactions with its environment (Institutionalism). As a result, the culture of the wider society is bureaucratization and formality, a need for organizations to be legitimized. Both Dingwall and Strangleman (2005) and Brunssen and Olsen (1993) conclude that organisation is fragmented and decoupled to imply that most organizational actions are ceremonial and a response to environmental expectations rather than being pragmatic. Moreso, there are no requirement of activities joined-up for coherence at any point in time (Dingwall and Strangleman 2005). This phenomenon is seen in the Finnish government's task of coordination (and immobility) practice said to be the Prime Minister's Office and the Ministry of Finance (OECD 2010; MoF 2002). No linkage between them was found from the paper analysis.

A historic account of the 1920s and 70s en route to Finland's modernization reveals economic nationalism inadvertently gave Finland new institutionally owned yet individualistically managed large-scale capitalist enterprises. The management model had a powerful vacuum as Kuisma reports: the faceless "state capitalist" was usually only represented by a passive supervising body, the administrative board, which was normally composed of politician, and tended to identify more closely with the company than it did with the owner. At least, where the more successful companies were concerned, the vacuum was filled with strong managing directors, who – ideally – combined traditional owner control with innovative entrepreneurship and the organizational skills of an independent manager (Kuisma 1999, 79).

Furthermore, it was found these successful managers ‘know it all’ from their entrepreneurial expertise. As a result, despite their personified nationalism and patriotism, the leaders defied crucial advice over their independent decisions which led to the loss of their well-intentioned motives for nation building. Significant to Kuisma is pointing out the fact that state owned companies’ managers acted against the wishes of another state organ and that of a notable influential leader. This observation hints of the know-it-all, independent and non-collaborative nature of the Finnish manager/leader irrespective of being part of, the consensus tradition of the Nordic region (Christensen 2006; Peters 2006; Pollitt and Bouckaert 2004; Brunsen and Olsen 1993).

The Finnish Literature Society wrote of Finnish mentality: Super ego sitting on independent weak and fragile ego has stifled individuality and entrepreneurship in the hitherto collectivist model despite its nation building advantages; with the 20th century drawing to a close, the construction of a conformist culture, collective mentality and political consensus has begun to change; for example, “Ministers’ say increased” (pp. 130) [consistent with the OECD (2009)]. The national self and the individual self are distinguishable. And among the generation who grew up in the safe atmosphere of the welfare state, the 1875 Topelian God-fearingness, self-denial, slowness and self-will in the low-context culture are collapsing.

The document advanced further that a post-Topelian mentality development includes believing in individuality, amused, self-assured and sociability. It is a diverse entirety that makes use of its low-context culture as an arena for rapid innovation, primitive creativity and inventiveness. Nonetheless, contemporary diverseness of the Finnish mentality is never devoid of equal *value* (emphasis added) of all citizens; and its further placement above all cultural hierarchies (The Finnish Literature Society 1997, 210). However, the document failed to record on the Finnish ethos of the public administration, the Finnish concept of leader and leadership, and about present day egotism. These are important ingredients for leading people, particularly, in the public sphere.

As the 21st century opens in Finland, so emerges new cultural and political systemic transformations, and the ‘new’ Finn assumed to hold new values (individuality, amused, self-assured, sociable, and equality); suggesting a beginning to communicate openly and freely. This observation appear consistent and a break through with the past to the extent that the European welfare state model repudiates the economic individualism which has been based at

odds with individualism: social achievement, a community of interests, social as well as economic interdependence, and most divergent, redistribution of wealth and resources to provide a social safety net (Bozeman 2007, 6). A recently assessed professional ethical value in Finland reveals a competing dyad of traditional values and new economical values (Ikola-Norrbacka and Jokipii 2010).

With that enjoin the economic individual's presence in Finland; with its full-fledged market economy (Tiihonen 2001; *Helsinki Sanomat* 2011). This assertion is easily confirm: Heikki Paloheimo, for instance, writes in the *International Edition of Helsinki Sanomat* March, 31st that the labour market organisation dictates the pace of labour and social policies to the government. Barry Bozeman recalls the French political philosopher Alexis de Tocqueville's "economic individualism as a philosophy of moderated selfishness in which one favours one-self and perhaps a small family and friends" (Bozeman 2007; 4). As a terminology, "Individualism" is defined as social theory advocating the liberty, rights, or independent action of the individual (Dictionary.com). This falls in line with the traditional and widely accepted theory of rational dictates. That the agent acts in ways that maximizes ones expected utility which is identified with promoting one's personal interests, or satisfying one's desires or preferences (Superson 2009).

Furthermore, globalization has hit Finland with this calculated economic interest for both individuals and businesses. StoraEnso, a Finnish firm with Finnish Government as capital shareholder moves jobs away from Finland for better calculations irrespective of government (remember Kuisma's Finnish Government faceless capitalism), Parliament, citizens and workers plea and demonstrations (Asp 2009). This could be seen as a repeat of the old tradition of entrepreneurial expertise and the know-it-all syndrome for ignoring national interest and public value. This phenomenon adamantly leaves the Finnish private sector managers tall (OECD 2010), as ever besides their aspirations and egotism unshaken by time and events.

The OECD measures in Finland the public managers stand short beside the tallness of their private sector counterparts; as it was further viewed as a Nordic culture of reluctant leadership in public administration. An attempt is usually being made at appearing equal in stature. Citing that in Finnish culture no one person should visibly have more or be more than anyone else (remember value of equality emphasised above). Further aggravation from the

public-sector culture of expertise means that leaders should not be seen as being higher than the experts they are leading [but the reverse appears normal besides the meaning of lead] (OECD 2010). To the OECD, this may explain why in the Finnish administration the reluctance exists in taking up positions of authority [perhaps a justification for the Vision 2012 core “will to lead and develop” Finland (MoF 2003; 16)]. It could also be thwarting the assumptions of leadership development programs which may mean a missed opportunity to identify the next promising generation of leaders according to the OECD (2010; 21).

The OECD’s equality factor may stand true but not the short-standing beside the tall private sector leaders as the above discussions demonstrate. That synthesis fails to be institutionalised as the report noted power and reform interest turn to be parochial and individualistic. Aside, they are both from the same Finnish (national) culture but different working cultures and constraints. Also, observable are increasing young generation of politicians leading and working with near retiring civil servants of the baby boom generation. And, their longevity in service stifling reforms (OECD 2010). Recalling the first OECD review notes the challenge to horizontality “may depend on the view and development orientation of the leaders of that particular ministry” (OECD 2009; 31); and, in the subsequent report (OECD 2010; 10) “the leaders would not cooperate or collaborate.” Also, is the power struggle at the apex of the ministry between the civil servant and politician (Pollitt and Bouckaert 2004). These simply contravenes the general believe of Nordic cooperativeness (Peters 2006; Brunssen and Olsen 1993) mentioned earlier. Nothing so far leaves the public manager short in stature besides the private sector manager colleague.

Deductions on leadership at this point, especially, from the Finnish Literature Society, although egotism/individualism can make a case of its own; it may also be enhancing expert/manager/minister power as it has grown with time following the abolition of the ministerial boards (Finnish Literature Society 1997) and being a clear, Selznick (1957) social world pressure that is unrecognised and managed. This could also be due to the Peter Principle that diagnoses all managers incompetent (Mintzberg 2009). For Meier and Hull (2005) it would be the failure of the elected official to set the pace for the bureaucrat manager. Yet, another probability is, the economic individualism which is fast torpedoing traditional values in the new Finn. The OECD (2010) reported that the new emoluments for the managers has infuriated the expert and exacerbated the already strained relation with the generalist manager.

Now, to the expert's resistance in playing second fellow as observed (OECD 2010). These prompt concerns about the Finnish expert (manager) and its affiliation to general leadership. Elsewhere, engineering and science professional arrogance that intend concede the future to management and leadership has been sighted (Schein 2004). Similarly, other reports confirm that from the private to the public sector experts professional autonomy has hampered managerial development, corporate systems and governments, and even more in the European nations with Strong Welfare traditions (Ferlie and Gerathy 2005). Obsession or antisocial expert (Sennett 2008), and egotism are the experts' disease. Even the academia is not an exception; there was professorial opposition to the establishment of doctoral studies in the science of the state from the lawyers' faculty where its first professorial chair was created and housed (Lynn 2005; 35).

Fukuyama evinces expert knowledge to be real and genuine knowledge; but, each of the separate stovepipes or silos develops a corporate interest in its own survival that may not reflect the interest of the larger entity of which it is a part. Contending further that with time agents interests become misaligned with changes in technology or the environmental circumstances; ending with delegation being problematic (Fukuyama 2005; 73). Lynn (2003) calls this persuasive danger specialized expertise. Presumably, having reflected from the comment: "The expert may come to believe that his science justifies his exceeding his authority ([Price] 1959: 492), a pervasive danger in all organizations requiring specialized expertise" echoes Lynn (2003; 17).

Riggs (1994; 120) accounts for the source of professionalization of public administration (in the USA) emanating from the unplanned consequential forces of the Pendleton Act that sought for administrative merit: practical exams; open recruitment for positions, instead of ranks; and transient appointments among the states ended up in powerful networks. The combined ensuing forces resulted in "professionalism in general and to the field of public administration as an unsuccessful candidate for professional status." Professionalism in Public Administration, Riggs found, beside its consistency and efficiency has exacerbated the specialised function and very insular field rooted in politico-administration dichotomy myth.

The specialist/expert or professional unwillingness to align is enormous and well known. Whereas Riggs (1994) observe they resist hierarchical control; Sennett (2008) even describes them as antisocial and having no community. However, it is also found they have a

community of theirs based on substance: professionalism. The professional's external orientation of powerful networks of officials includes colleagues, schools, politicians and associations responsible for maintenance of professional standards (Riggs 1994). Loveless and Bozeman contend the professional would rather heed to their dogma of professionalism development and change; as a result of anxiety to maintain stature with peers by employing state-of-the-art techniques and tools; cosmopolitan and connected to external communication; amongst them informality promotes innovative ideas and adoption. But domination by a particular profession has the propensity to derail all these positives just as in any other change process that runs contra to the professional creed. Up to this point, it is clear the managerial environment is laced and mined with egotism, economic, poor social world pressure handling and, professionalism with its insular culture. These dominate the managerial apex and could or do hamper free and open managerial communication and implementation processes.

Commitment to the organizational values, interests and mutual respect between the experts and all other actors become a necessity but a challenge. The expert's acts could be perceived in two threads as reluctance management and outside management (Mintzberg 2009), as their refusal to cooperate and collaborate (OECD 2010), making delegation an all-time problematic in organisational management which affects efficiency negatively (Fukuyama 2005). As a result of strong minded opposition characterised by less communication (Golembiewski 1983); while protecting the rival groups competition is intensified undermining the formal system (Selznick 1957); such as issues of control, communication and coordination (Mintzberg 1979).

Cooperation and the Nordic region – Finland, Sweden, Norway and Denmark – is a well know phenomenon (Pollit and Bouckaert 2004; Brunssen and Olsen 1993). Brunssen and Olsen advance an argument that cooperation does not necessarily execute performance. Therefore, cooperative/collaborative resistance or barriers need explication as they have direct impact on reform and implementation communication processes and performance. Hansen (2009) offers four such plausible reasons as follows: 1) the not-invented-here barrier; this concept is the situation where people go outside their own unit to seek input from others; its causes being: a) insular culture – resulting from communication mainly inside a group and barely across to outsiders, b) status gap – as a result of not wanting to cross status lines, c) self-reliance – fixing one's own problems, d) fear – do not want to expose own problems and weakness.

2) The hoarding barrier is where people are not willing to help and share what they know: it results from a) competition – competing with colleagues and other units, b) narrow incentives - rewards for own goals, c) too busy – no time to assist others, d) fear – loss of power should knowledge be shared. 3) The search barrier is the inability to find information and people in an organization. This happens as a result of a) organizational size – common problem of large companies, b) physical distance or geographic – distance makes search difficult, c) information overload – too much information makes search difficult, d) poverty of networks – lack of links further aggravates search; and finally, 4) the transfer barrier: People are unable to transfer knowledge easily from one place to another. Its causes attributed to a) tacit knowledge – generally, difficult to transfer, b) no common frame – inability or simply don't know how to work together, and d) weak ties – no strong relations to ease transfer (Hanson 2009).

Worthy of notice from the explication are two things shelving the Hanson four-barriers, namely, “willingness” for the first two barriers of not-invented-here and hoarding; while the search and transfer are anchored by “capability”. Willingness and capability are therefore the driver forces of behaviour and attitudes in the organisation and must be recognised and managed effectively. The weaknesses and practices identified so far are consistent with these findings. For example, the transfer barrier could explain the lack of evaluation utilization (Patton 2002) and feedback process identified with the Finnish public administration (OECD 2010; Pollitt and Bouckaert 2004). Further revelation is that willingness harbours ‘fear’ (negative value) and that thwarts capacity building and performance. In other words this is value and skill based issue affected by egotism, power and economic individualism. Time constraint is envisaged as well. These may set the very base of the problem which appears to be culture embedded affecting communication and implementation performances. More intriguingly, it might have also led to non-reforming of the tall ministerial hierarchy (turning to structural problem) due to self-interests and self-protection [status theory (Mohr 1982)] affectionately labelled as silos within which, working across units seem impossible (Peters 2006). They are a lateral form of decentralization with no correlation to the centre as research shows (Mohr 1982).

In a similar process of dissipation of such enormous entropy to avoid responsibilities and constructiveness, Bardach (1980) Implementation Game theory notices open resistances and

a number of games resulting in the policy and implementation processes to undercut performance and goal deflection. Tenacity is one of such an entropy phenomenon common with the individual and groups including bureaucrats, professional, politician and interest groups. It is the will to thwart the development and progress of programs until one's own interest is satisfied; although the intension is not to curtail it but may eventually create lengthy delays or end up doing so. Territory game is yet another with all bureaucratic organisations being fond of. It is observed mostly within competitive or rival bureaus with overlapping jurisdiction or similar missions. Not Our Problem (similar to but different from Hanson's not-invented-here barrier) is another bureaucratic game. Bardach observes that ideological commitment to laissez-faire; inability and unwillingness are to blame. This Not Our Problem extreme form is Their Fault. In this form proponents push away possible blame and could go to the extent of pointing to a scapegoat.

The rest of the games are the Odd Man Out and Reputation. To the Odd Man Out, Bardach argues, if the ultimate success of a policy and its implementation partly depends on the relative autonomy of other actors and their contributions. Games played and observed include the creation and sustenance of choices depending on benefits/losses; continuous monitoring of the remaining uncertainty, and, of course, tempting others to do away with their choices too. Reputation, likewise the other games, harbours the individual or organisation entities, private or public lives. The evolving games differ from situation to situation. Based on economic interest, Bardach (1980) postulated that the implementation game players have ambition and its realisation as the one dimension of their private lives. His argument is that ambition has everything to do with reputation games. Reputation, however, could be considered a product of or facilitator; also partly as an end in itself or as an instrument for achieving others such as re-election, gain promotion or a show off at next round of implementation. In the event of independent significance game of Reputation, actors, especially seeking boldness, courageousness or innovativeness figure out how to communicate and persuade an audience that they are doing more than the ordinary. Next is a glance at how this entropy, capability and will impacted on bureaucracy.

2.0 The Weberian Rational-Legal Bureaucracy and Culture

Meier and Hill (2007; 52) would advise the definition of bureaucracy must be based on the authoritative Max Weber (1946) source that defines bureaucracy in formal and structural terms. While recognising today's advancement of technology over paper in records management as an exception, the six bureaucratic characteristics listed are:

- Fixed and official jurisdictional areas ordered by rules, laws and regulations;
- The principle of hierarchy whereby structures are established with superior and subordinate relationship;
- Management of the office relies on written files;
- Occupation of offices based on expertise and training;
- Full time employment of personnel who are compensated and who can expect employment to be a career;
- Administration of the office follow general rules that are stable and can be learned.

In looking at bureaucracy in the twenty first century, they reviewed challenges such as politics (centralised and fragmentation systems), the New Public Management, postmodernism, principal agent model [untested (Bozeman 2007; Minogue 2001)], the rise of networks, and the architecture of complexity concluding that “bureaucracy would continue to flourish in the twenty-first century for many of the same reasons that it has flourished in the last century, it facilitates the governance process in ways that other organisational forms do not [consistent with Caiden 1994 J-Theory]. Challenges to bureaucracy will always be challenges at the margin, moving tasks from a public sector bureaucracy to a private sector one, for example” (Meier and Hill 2007; 67).

Furthermore, Meier and Hill (2005) argue the challenge of contemporary bureaucracy is located both in intellectual and practical debates that take place in the academia and political fields; respectively, that shape the direction of government and governance. “Fields”, according to Lynn, inferring from other ideas of Bourdieu and Hood is an arena for intellectual forces and power relationships in a capacious sense; covering the academic knowledge, common knowledge of the educated and the ruling elites dealing with how to conduct the affairs of the state as well as those elements, social and behavioural disciplines dealing with contemporary study and practice of public administration (Lynn 2005; 28).

It is a clear consequence of the Finnish Government and others in recent times having to shift post to seeking for alternative paths of delivering public services other than through public bureaucracies and responsive management experimenting with debureaucratisation to raise productivity following criticisms (Caiden 1994; Meier and Hill 2007). These researchers

observe that on a large scale, the institutionalisation of legal-rational authority of bureaucracy makes it more productive than other alternative forms of organisations; however, studies show how its functional elements such as specialisation, hierarchy, rules, managerial direction, impersonality and professionalization can undermine it if overdone; leading to dysfunction, unproductivity and resulting in the alienation of both employees and clientele. Organisational analysts would perceive this problem as the inability of people to adapt to bureaucratisation despite Weber's warning on it. "Bureaupathology" is what Caiden (1994; 30) uses to describe these conditions to suggest "the pathologies or sickness or shortcomings of the bureaucratic form of organisation; [arguing] that if bureaucratisation process is carried too far, if it is hastily pursued, and if it is misapplied then the virtues turn into vices."

Advancing his argument, Caiden notes, limiting one's search for some main causes to Weber's conceptualisation of bureaucracy was enough "for within each characteristics lay the seed of its own decay" or put another way: "if one over organises, if one over bureaucratises, then the same virtues become vices, and if not reversed or corrected or compensated, they will result in self-destructive tendencies, which if not halted in the time may eventually lead to organisational demise". Caiden deems the necessity in both listing and discussing the cause-effect of these pathologies consistent with others (Meier and Hill 2005; Taylor 2001; Glombiewski 1983; Selznick 1957).

Elaborating on one of such excesses he called Management by administrators [the envisioned job bank model of the Finnish Government reform although to be contracted rather than careering] affectionately known as the Administrative Class: A bureaucratic practice requiring the full-time employment administrative generalist to manage the organisation operated by specialists who produce and deliver its goods and services. As usually tagged, this class of managers dominate the upper layer of the hierarchy and making the decisions and allocation of needed resources by the specialists among others; thus the administrator takes care of all the extraneous factors while the specialists concentrate on performing their duties smoothly; following the concept of staff and line; ending up with harmony, agreement and efficiency.

But where administrative rule is overdone it is observed most of the top positions are captured as well as the privileges by the administrative class and superimposed on the specialists line managers. This action informs aspirants to the top to switch over from specialist to administrative generalist to be privileged too. Caiden further observes an

important phenomenon that the state “loses the best of its line practitioners, the masters of their crafts, and gains uncertain, inexperienced, untutored administrators, whose performance is probably mediocre on work they perhaps do not enjoy and never quite master” (pp. 36), bringing back to mind the Peter Principle of incompetence (Peter 1966; 2011) by which careers and professions at their peaks are crowned. Such practice is enormous cost to society and institutions/organisations. By administrative rule excess administrators fail to see themselves in a support role but leadership role; thus “public officials cease to be civil servants and turn to be uncivil masters” (Vedung 2002; 228). In that wise organisational success is their organisational leadership; therefore marketing success is more important than achieving success.

Caiden’s (opcit) overbureaucratised organisations demonstrate bureaupathologies on an extensive scale suggesting a J-curve effect. From the foregone discussions bureaucratisation processes have been hasty, over stretched and misapplied ending from virtue to vice. By analysis and experimentation he argues one is able to locate the position of functional and dysfunctional transition zone. Likening the zone’s arc to the “downward sloping curve of marginal utility, save that in this case, it is the downward sloping curve of productivity, or to be much more exact and precise, organisational deficiency, for it is efficiency that will decline much before productivity, until further bureaucratisation results in inefficiency then loss of productivity and certainly dysfunctionality” (Caiden 1994; 31).

The Caiden analysis within the Weberian bureaucratic parameters recommends safeguarding its self against bureaucratisation by paying attention to each bureaucratic element, work integration, job rotation, mechanisation of routinized operations, and wholistic view of workers for collective is prized over individualism; and, work not over education and so on. The article, however, failed to pay attention to the motivational forces behind such excesses. Nevertheless, nailing incompetence, quest for administrative rule and leadership, riches (economic) and fame, and professionalism or class and power could be responsible for the excessive bureaucratisation outcomes. These match the earlier findings bundled as capability, will, culture and noncooperation. Any one of these elements could stall communication and affect implementation. Bardach’s economics and ambition of the individual; the new challenge of the Finn thus between economic and traditional values become apparent. Consistent and explainable of these behaviours are theories such as the Caiden’s J-Curve, Bardach’s Implementation Game, Vedung’s theory of bureaucracy’s self-regarding behaviour, the attitude mismatch theory and regulatory capture theory. They also provide anchor to the on-going discussion.

Normally and generally, public bureaucrats and their bureaucracies may have their own interests that conflicts with that of the principal's. To go with their own interests, Fukuyama (2005), Vedung (2002) and Bardach (1980) assert the agency may try to twist the government policy mandate to fit its own purposes; with the particularly influential view of the conception of bureaucrats as budget maximizers: enhancing their personal reputation, salaries, fields of influence, as well as other self-serving goals; and/or may doubt the efficacy of the intervention. As a result, faithful implementation of actual substantive policies fails to be a priority. The theory of bureaucracy's self-regarding behaviour is normally applicable to agency managers, other individual bureaucrats, and unions (Vedung 2002); and, its version of Pork Barrel describes the elected officials acts whereby expectations are defined and legitimised with excesses of it undercutting program managers performance (Bardach 1980). These excesses drew in a paradigm shift to the NPM which is the next focus of discussion.

2.1 The New Public Management (NPM)

Besides the Weberian bureaucratic tradition's excesses and others including economic in the build up to the late 1970s and early 1980s, the NPM was born as against state ownership and centralism with a number of tenets including devolution and decentralisation, market, competition, contracting, customer services orientations, and performance pay all in the name of performance efficiency and effectiveness (Christensen 2006; Taylor 2001; Rhodes 1997; Kickert 1997). However, the theories and ideas fermenting them were poorly developed and, not tested (Bozeman 2007; Minogue 2001); although they were not new ideas after all (Pollitt 2003; Minogue 2001). Christensen (ibid) argues further they provide no bases for organisational solutions; however, they have the positive element of democratic control. They are fragmentary (Peters 2006; Rhodes 1997) and fail to be an overall smart policy with characteristics of feasibility and desirability (Christensen 2006).

Taylor (2001) explains superficially, the NPM and HRM (human resource management) are different but the same ideology split by academe. While the NPM dealt with broad managerial change and strategies in the public institutions HRM took on the specialist function of people management pertaining to the private sector. He established they came from the same source, the New Rights. Their theoretical undergirds and values are the same, as well drawing from the same support source. It was a reaction response to the 1970s

economic, social, political and cultural changes; 1973 oil crisis; rise of the Japan and Asian Tigers; and locally the dominant power of trade unions of the West. Taylor outlined three criticisms of NPM/HRM as ignoring organisational power relations, fails to take context into consideration and divides policy and implementation; thereby, distorting strategic direction. The level of a country's NPM swallow determines Pollitt and Bouckaert's (2004) three categories identified and named: core NPM, 'neo' Weberian and hybrid. Respectively, while New Zealand, Australia and the UK belong to the NPM marketisers Finland and other Continental Europeans are modernisers; and, the USA caught in the hybrid brand.

The Weberic rule bound personnel management is replaced with NPM flexible and responsive performance management (Brown 2008; Taylor 2001). Taylor, however, deviates from the NPM/HRM tenets and gives preference to contingency based reforms and centralisation. His preference is this study advocacy. Thus, the unity of purpose for best correspondence index to imply strategic process and its implementation must be aligned (Yukl 2010; Drucker 2008); well integrated from formulation and design stage (Van Mart 2005; Bardach 1980); and, having the fixer in mind (Bardach 1980) and with a communication plan.

2.1.1 The New Public Management and the public manager

Two decades of the new public management (NPM) outputs include 'new public managers' of two categories: 1) *senior public officials* within the central departments and 2) the *top executives* of quasi-autonomous agencies (Thiel et al. 2007; 90). They contend that the two managerial functions are the outcome of the reforms started in the 1980s when most Western Governments changed their ways of working to reduce size and cost as well as the introduction of some new management techniques from the private sector such as setting performance indicators and human resources management. The personnel reforms eminent as new skills and competencies (Thiel et al. 2007); and, to the top civil servants the 3Es - of economy, effectiveness and efficiency - (Rhodes 1997) were now the basic requirements for government officials into their new turf of market-type mechanisms. The cores of this strand of the reform were three reform issues: (i) a reduction of security of permanent tenure (ii) often on performance-related contracts because (iii) performance and managerial competence became more important criteria in decision to hire and fire top officials (Peters 2001; Pollitt

2003; Pollitt and Bouchaert 2004; Rhodes 1997). These fall in line with the Finnish Government Vision 2012 reform strategies (MoF 2003).

Furthermore, on top officials, Halligan found that these managers may be a mix of range of generalists and specialists for policy, managing, delivery, regulation and technical work as well as coexisting with private sector technocrats and political operatives. The response and implementation of these personnel reforms depended on the existing or traditional civil service structure and model of a country. Theil and Homburg (2007) cite two ideal types, system- career-based and position-based from PUMA (2003). Or put differently as observed above, it is closed and open systems respectively. But Peters (2006; 126) contends without the career or professional civil servant effective [communication and] coordination in government and institutional knowledge is inhibited. In the Finnish case it is a poor mobility (OECD 2010) and closed/career system; and, the hope is to open the apex into the proposed pooling and mobile system by the on-going reform (MoF 2003) thereby developing managers with broad view of government (OECD 2010).

Thiel et al. preliminary findings of the new NPM manager was that senior public officials remain more classical neutral policy expert who advises politicians on decision and policies and much less the manager aimed for by NPM reform. Managerial skills are less valued, and subordinates do not see their senior managers as a “leader”, they stated; and concluded that there is even some hint of resistance among senior public officials against NPM reforms (Thiel et al. 2007, 105). Credit, however, is due the NPM/HRM reforms for bringing to the fore government manager development.

3.0 The Public Manager Policy Environment

3.1 Structuration process

The means-end thinking remains problematic pre and post NPM (Christensen 2006; Vedung 2002) development of fragmentary silos. Hill and Hupe (2002) observe no ready-made answers for public managers and the practitioner generally. Out of silo-zone-thinking must be a necessary requisite for such searches. The transcend limit includes analysing the capture processes engrained in the institutional setting, socioeconomic and political context and the business and social community, depicting their political capacities, competing actors and

influence and occurrences in their broad environment. For example, Fuchs (2007) and Galbreith (2009) view business acting ranged from traditional passive to modern active role in the restructuring of the setting both locally, internationally and even globally for their self-interest sustenance; a process Scholte (2000; 200 91-2) tags methodological structuration: [Wherein] “the course of social history result from mutually constituting agent choices and structural dispositions ... structural forces largely establish the range of option that are available to actors in a given historical context. Structures also generally encourage agents to take certain steps rather than others. At the same time, however, structures depend on an accumulation of actor decision for their creation and subsequent perpetuation. Indeed, at moments of structural instability and flux, agents can have considerable influence in reshaping the social order”.

The structuration process architect notes the agent-structure debate involves three general contending positions. One such contention is the methodological individualism that supposes: social relations are wholly propelled by the aims and decisions of actors. Among such agents are government institutions, firms, civic organizations, small groups and individuals. From an individualist (or voluntarist) position, globalization has resulted from an accumulation of initiatives taken by persons and associations of their free will and from primary forces and their interconnections between rationalism, capitalism, technological innovation and regulation in the causation of globalization (Scholte 2000); as well observed in the NPM Internationalisation (Minogue 2001) but imposed on the developing world (Minogue 2001; Peters 2001; Pollitt and Bouckaert 2004) against their free will.

The theoretical and conceptual explanations depict the complexities of and for the actor and for that matter too glaring to remain in the silo-slab environment, let alone, to mention the ethical rational manager’s plight. For example, Pollitt (2003) argues that it is a responsibility of the public manager to understand a wider and a changing society. Whereas Hall and O’Toole (2000) established that the public sector is a multilevel and multiactor organization as such requires skilful leader for implementation; Pettigrew, Ferlie and Mckee (1992) call for skill to manage dualities, dilemmas, connecting the top-bottom, while maintaining stability during the change process; not without the consent of the governed (OECD 2010; Eddy 1983; Dingwall and Strangleman 2005). Bardach (1977) would require the role of the fixer to be incorporated right at the basic policy design and planning stage if things are to work well and efficiently. Van Wart (2005) thinks the design stage is considered even more important than implementation. Not forgetting the earlier mentioned national framework for

discursive quality, coordination, networking and regulation in the governance process (Habermas 2008).

In addition, Selznick demands a prioritised organization science and policy studies for all managers. His reasoning roots that the executive becomes a statesman only when the administrator/manager successfully transitioned from administrative to institutional leadership is achieved; that is, the executive's reassessment of the own tasks on the one hand; to the other, of the needs of the institution itself; labelled institution rather than organisation because of evolvement from its simplistic designed tooled form to its organisational entirety of the changing aims and capabilities as a result of adaptation (Selznick 1957).

But these tasks and needs have failed to align for generations, ending up as silo-slab systems ending up as the rational ethical manager's woes (Dingwall and Strangleman 2005). As mentioned already one of Mintzberg's (2009) management conundrums observes every manager is incompetent but fakes it up in frustration; the source is due to how managers ascend the hierarchy by promotion to its apex and, of course, their level of incompetence invoking the Peter Principle (1969) of management. The Peter Principle notes as people rise from the action based of the specialist to the abstract planes of the generalist, they become disconnected from what they are supposed to manage [including communication and implementation processes]. Yet some have to manage, hence the conundrum which is consistent with Caiden's (1994) Administrative Class and the J-Curve.

In that conundrum and many other senses, Golembiewski (1983; 193) is right to prescribe that "all problems are organizational." Golembiewski contends that as a result of the interpretations in the management unit on the policy operationalisation process (Dunsire 1990), leads to the production of goods and services. The narrow span of control is designed to facilitate extra subjugation in the details of operations that imply the structure encourages centralization at M_{ABC} functional operation level. This means the manager alone makes reasonable decisions about the flow of work in the organisation of personnel (A), finance (B) and operations (C). The manager alone controls the assumed stable management unit shown in Figure 3 below. Its properties including authority being vertical or hierarchical relation; with department organised around similar activities but with different names at different levels: functions at high and process at low level of the organisation.

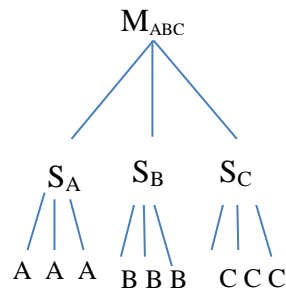

Figure 3: A structure or management unit (example $M_{ABC} + S_A$) consistent with the principles of bureaucracy adapted from Golembiewski (1983; 194)

Most importantly, Golembiewski notes that the principles of bureaucracy went beyond being mere structural material; but philosophically and powerfully reflected the minds, thinking and talking of actors and people generally. By structure Lynn meant the formal means for constraining and overseeing how public managers deploy state authority. In this wise, the dual elements are the lawful delegation of authority, and the external control over the deployment of delegated authority.

To Fukuyama delegated discretion – cloudy goals, linear communication from top-down, and decentralization - is the singular core of organizational theory. For efficiency purposes and performance, the delegation of discretion in decision making and authority occurs. Unfortunately, the very act of delegation creates problems of control and supervision (Fukuyama 2005; 59). The delegator-delegatee relationship defines authority. And, Simon views it as a two-way individual process whereby one has the power to make decisions which guides the actions of the other; thus the superior frames and transmits decisions with the expectation that they will be accepted by the subordinate; and the subordinate expect such decisions with his/her conduct determined by them not withstanding his/her own judgment merit as of the decisions (Simon 1997). But for now, Mohr has a narrative.

Organizational structure since the 1900s was viewed as artefact and a matter of choice; later it was observed to be amendable by forces such as technology, environment, size and uncertainty (Mohr 1982). Expressing this in the dimension of bureaucracy, Mohr views the fundamental theoretical idea of structure to concern a particular occurrence of

bureaucratization or decentralization that offers precise response to an uncertainty. Contending that structure: “is a single manager at any hierarchical level and the subordinates to whom the manager might delegate authority and responsibility” (1982; 104) as in the Management Unit pictograph in Figure 3 above shows. Structure is with an in-built right of decision for a subordinate (Dunsire 1990) as depicted from the different perspectives definitions discussed above.

To problems of aggregation due to heterogeneity, Mohr’s structure of an organization’s high level manager concerned with several types of environment and technology, the manager should structure the flow differently for the different tasks. Mohr (1982) argues that even in an uncertain situation the manager is expected to follow the basis of centralized authority structure for the most part or in principle; and, to defer systematically to specialist with more expertise in those specific areas which is deemed necessary.

The second problem was outlined as the pivotal concept in the definition of bureaucratic structure as centralization. Perceiving decentralization as part of the bureaucratic structure and where authority is ceded as structural result of need to cope with an uncertainty with appeal; rather, the misinterpretations departs it from bureaucratic structure. Empirically, a negative correlation connects decentralization and bureaucratic structures including specialization and formalization. Mohr’s two kinds of decentralized authority are operational and true authority. While the former is delegated to carry out assignment with necessary guideline and without close supervision but effective oversight from above and effective appeal from sides and below; the latter, true authority is with de facto or ultimate authority.

In this second type, decentralization means where the hierarchical official cedes or loses the capacity to exercise effective oversight; even in the absence of politics, Mohr observes, this occurrences are normal organizational life whereby subordinates at any level possessing critical skills and/or information that the executive does not effectively control [remember the obsessed expert/professional and delegation as a problem]. The structural connection of authority between superior and subordinate only exist when the objective and behaviourism occur; thus the behaviour pattern is demonstrated by the superior’ command and the subordinate’s expected acceptance as a criterion of choice (Simon 1997). Mohr remarks: governance will proceed in part by joint decision by supervisor and subordinate, teamwork, consensus, democratic process and so forth.

Quoting from Weber that “organized in a clearly defined hierarchy of offices”, Mohr (1982; 107) “recognise[s] the term *hierarchy* means the structure in which operational authority is successfully delegated, while ultimate, or true, authority is always retained by the delegating official”. It is from authority that an organisation derives both its formal structure and the most influence of member behaviour (Simon 1997). Amazingly, Mohr concludes from where he started: there is no escaping from the fact that organizational structure truly is a human artefact, and as such, it is the result of motivated behaviours [self-interests against organisational]. His solution is to strengthen regularity connection with the uncertainty and strategy of control in a manner that avoids give away all structure to technology and environment; and “to motivational roots which are powerful and ubiquitous” (pp. 111). Mohr’s conclusion has been consistent with the earlier synthesis calling for conscious management of capability, value-will, and commitment to organisational values for performance contrary to personal selfish interests.

Structure is seen from the analysis as a process and a product; and, of course a practice. Both Mohr’s diagnoses and prescription are embedded in culture as suspected earlier. Fortunately, assessing culture for a change is possible (Schein 2004; Dingwall and Strangleman 2005). Traditional hierarchy will always be around (Fukuyama 2005; Meier and Hall 2005; Caiden 1994); and provides the basic requirement of governance accountability, especially, to novice politician at the top (Meier and Hall 2005); as a short an accountability chain it eliminates slippage between top and bottom, Meier and Hall argued. However, this simple feature of accountability that even the political novice can take advantage of is problematic in silo-slab system, perhaps for its excessive height (Caiden 1994); predominated by self-accounting amidst of the so-called performance management (OECD 2010), demonstrates the depth of the structural problem that could inhibit performance and efficiency.

Meyer and Allen (1997) found out variables of organisation structure affects commitment: affective commitment is sighted with decentralization; perception of the fairness of policy and affective commitment; ways and means of policy communication also affectively committed; it impacts on demographics (age, gender, tenure) and dispositional variables (personality, values). People perception of their competency affectively commits much as employees with high need for achievement and strong work ethic go with affective commitment. On work experiences strong levels of correlation exist with job scope that is,

the challenges, autonomy (not independence) and skills employed; employee's role; relations between superior and subordinate affects commitment and work implementation processes.

3.2 Collective Commitment

“OECD: Collective commitment, strategic insight and resource flexibility needed in Finnish public governance” has been well advertised at the website of the Government as Employer Department of the Ministry of Finance shortly after its release (31.05.2010; OECD second review). Perhaps, in search for strategic agility in the governance process as it stands as the main recommendation for the silo-slab management while ignoring the primary influential communication fraught with difficulties. This prescription would not function without Implementation Communication. However, it makes a great start off point of this discussion. Albeit the OCED (2009; 2010) resources did not include this policy understudy whose core is value/will based (MoF 2003; 16) or its government source material of State Civil Servants Act 94/750. However, it aligns with their output in values terms. Therefore, these coincidental matters become the real substance for this discussion and for that reason the policy choice.

In a fragmented system Meier and Hill observe that the electoral institutions have failed to define a precise role for bureaucracy; as such, the bureaucracy itself becomes a more political institution that seeks to aggregate political power in support of policies and their implementation. It is deducible that the problems lie in choice of values, their alignment and implementation. They argue the important question is what values are resident in the bureaucracy; how these values compare with both those in electoral institutions and that of the general public (Meier and Hill 2005)?

From all the divergence, these two questions seem to be the point of convergence; they are both based on Values and Values communication system and implementation. That is, what are the requisite political or the elected values? What are the appointed rational ethical manager's values as well the governed? How are they related and interconnected? And how effectively have they been communicated generally and specifically for implementation? The OECD's collective commitment value becomes the central cementing material for all the parties involved for common national values, interests and goals, taking it from that

perspective. The strategy is to first discuss commitment and then zoom in onto value theory generally for grounding.

Worthy of notice is a complaint from member countries spelling the lack of dedication to the underlying values of public service and the interest of the citizens served as well as the lack of know-how by the OECD to resolve problem of public managerial commitment and how they in turn bring others on board (OECD 2001). Although the importance of leadership may depend on the make-up of a particular society, developing leadership is more important in a diversified society than in a homogenous society (OECD 2000) is an understatement. Rather, leadership in manager development is of equal importance to any system or society but must depend on need. As it is observed that the degree of relevance of leadership is even more important in individualistic cultures (Pfeffer 1997; 130).

‘Homogeneous’ Finland, for instance, with a public sector highly fragmented into stovepipes (OECD 2010; Pollitt and Bouckaert 2004) may probably require more and intensive manager development than a diversified but cooperative and collaborative system like Singapore. Leadership is a collective commitment process of marrying top-down pressures and bottom-up concerns as well as to the purposive networks (Pettigrew, Ferlie and Mckee 1992; Rhodes 1997; 2006). Important to note is that when commitment to organisation is measured it is more or less measuring employee’s commitment to top management or to a combination of top management and local foci Meyer and Allen (1997) citing a host of sources.

Pfeffer recommends: Commitment may be a much more efficient as well as more effective means of coordinating and managing behaviour. Commitment is a rational behaviour in which it is possible to induce an individual to do something and this behaviour cannot be attributed to some powerful external force such as a reward or sanction (1997). But commitment varies, and it might be another thing such as the opportunity to do important and challenging work, to meet and interact with interesting and important people, to learn new skills and develop as a person, and so on (Meyer and Allen 1997).

Pfeffer continues that the person becomes more committed to the action and to its implications for other attitudes and behaviour. As a result, commitment processes create fundamental change in perceptions and attitudes, and in that sense commitment represents internal control that does not need to rely on nearly as much on continuing surveillance and

reward which are external. For emphasis Pfeffer (1997; 116) quotes Simon's (1991, 37): "Willingness of employees at all levels to assume responsibility for producing results – not simply following the rules – is generally believed to be a major determinant of organizational success".

Taking verbatim from Mowday et al. (1982) Meyer and Allen (1997; 9) distinguished attitudinal and behavioural commitment as: "attitudinal commitment focuses on the process by which people come to think about their relationship with the organisation. In many ways it can be thought of as a mind set in which individuals consider the extent to which their own values and goals are congruent with those of the organisation.... Behavioural commitment, on the other hand, relates to the process by which individuals become locked into a certain organisation and how they deal with this problem." And they further observe that the positive-side have advantages for working in such an organisation with practices promoting commitment such as apt to learning. But to the down-side, committed means having no time and energy for other things; with the danger being these committers might turn to be less concerned about developing marketable knowledge and skills that will keep them updated and even for precautionary purposes just in case the organization ceases to exist.

Commitment is characterised by the possibility that an individual could have multiple holdings at a time but NPM/HRM encourages organisation commitment only which undermines commitment generally (Taylor 2001). The base elements: affective, continuance, and normative are psychological states that characterised the person's relation with the entity in question and have implications for the decision to remain involved with it. The Meyer and Allen (1991 in 1997; 11): "Three-component commitment is framed that affective commitment refers to employee's emotional attachment to, identification with, and involvement in the operation. Employees with a strong affective commitment continue the employment with organisation because they want to do so. Continuance commitment refers to an awareness of the costs associated with the leaving the organisation. Employees whose primary link to the organisation is based on continuance commitment remain because they need to do so. Finally, normative commitment reflects a feeling of obligation to continue employment. Employees with a high level of normative commitment feel that they ought to remain with the organisation."

From that model, and the absence of collective commitment in the Finnish Public Administration (OECD 2010) views the question "'trapped' into becoming committed" (Selznick 1977b in Meyer and Allen 1997; 4), remains legitimate and calls for a study, moreover, when mobility is generally poor in the system. Observable is the continuance of membership to the service; and their longevity, behaviour and attitudes influencing reforms and leadership, and others negatively (OECD 2009/10). Remarkably, the cost based

commitment is visible (example, pension reward, performance pay) it appears to run contra to the process of commitment generally. The NPM hard run performance management and contracting undermine commitment moral (Taylor 2001).

Both Taylor (2001) and Meyer & Allen (1997) appeal for attention to commitment management in the processes of change management, and human resource management policies and practice. They established that survivors of reforms have weak commitment as it appears to them to have marketable skills and capabilities akin to Vedung's (2002) goodwill towards the prospective employer. In furtherance, this should be managed to the achievement of becoming the organisational citizenship or extra role-behaviours (Meyer and Allen 1997); or zealots (Vedung 2002); which is explained to include such things as going above and beyond one's job description and set targets to include volunteering, assisting others for one is known by the observed actions but not job description contents (Morgan 2006). Organisations must therefore encourage stronger will to engage in organisational citizenship, especially, for the manager and between the manager and the expert; and all other stakeholders. Commitment, they argue, should be complementary to and not a competitive tool for organisational development.

3.3 Value-Will Theory

Knowledge of ethical leadership being in short supply and rarely even discussed (Bass and Riggio 2006; Shafritz and Russell 2003) makes it pertinent a discursive focus for comprehending values and institutionalisation in management development process following the introduction with commitment value above. Inferring from the totality of this everyday experiences it is obvious society is dynamic although some elements remain static as sociology observes. With time changes individuals, people, organizations and governments turn to have relatively permanent goals and values due to forces that affect attitudes, behaviours and processes. This was seen in Mohr's (1982) powerful and ubiquitous motivated behaviours that determine structure of organisations. There were also other sources from the review that affected attitudes and behaviour that could jeopardise organisation function and goals. For that matter, values do matter as they appear strong determinants of structure and policy contents and its implementation processes. Features observed from the discussions, especially, from commitment turn to benefit Bozeman's four characteristics of

value: a) is relatively stable, b) have strong potential to affect behaviour; c) changes; and d) helps define one's sense of oneself.

A value, then, "is a complex and broad-based assessment of an object or set of objects (where the objects may be concrete, psychological, socially constructed, or a combination of all three) characterized by both cognitive and emotive elements, arrived at after some deliberation, and, because a value is part of the individual's definition of self, it is not easily changed and it has the potential to elicit action" (Bozeman 2007; 18 & 117). It is necessary to make a clarification here that there are individual and public values. However, the individual values may intersect or even differ from public values that a government seeks to lead and manage. Bozeman, however, was quick to point out some distinctions, that public values do not mean the same as government responsibility; and public value is distinguishable from public values theory. Also, public values and institutional arrangements are not necessarily logically connected. But often the temptation is to use public values as a standard for measuring institutional arrangement for both goods and services. Implying public values neither support government nor renounce market but may align some other time.

In *Managing Publicness*, Barry Bozeman is identical to managing for public value although in practice "public management may seek economic efficiency, it may serve or it may follow the dictates of narrow interests, or it may focus on 'side payments' and the self-interests of public managers among other possibilities" (Bozeman 2007, 175). Values vary from individuals to society as Pollitt elaborates: democratic values serves the common good rather than sectional interests, promoting public accountability, supporting elected representatives, always observing the law; professional values [compare Vision 2012 values] involves promotion by merit, continuous improvement, impartiality, effectiveness, creativity, loyalty to professional colleagues [that is, the only trusted community of the antisocial expert (Loveless and Bozeman 1983)], putting the clients interest first. General ethical values, Pollitt adds, are about integrity, honesty, equity, probity; and people values involve reasonableness, civility, respect for differences, kindness. This classification permits overlapping that facilitates discussion of the different domains of ethics that may get into the daily function of the public manager (Pollitt 2003, 135).

Bozeman explains: Public value of a society are those providing normative consensus about (a) the rights, benefits, and prerogatives to which citizens should (and should not) be entitled;

(b) the obligation of citizens to society, the state, and one another; and (c) the principles on which governments and policies should be based. Furthermore, the individual's public value defined as: the content specific preferences of individuals concerning, on the one hand, the rights, obligations, and benefits to which citizens are entitled, and on the other hand, the obligations expected of citizens and their designated representatives (Bozeman 2007; 13/132); [Remember Meier and Hall's (2005) connecting values discussed above].

It is noted that the search for public values has merit in its own self; in consensus and also describes the state of affairs as seen in the OECD (2001) complaint and the Finnish Constitution (1999/2007) demonstrates. One best place for Bozeman's prescription for seeking public values is by intuiting about what is repugnant and what that means for public value. Questioning people and they willing to reveal information (examples, opinion polls, surveys and so on) provides individual values and individual public values and interests. This whole review so far points to several sources for public values including the cultural artefacts and traditions, government documents and scholarly literature. Bozeman reveals the critical challenge comes not with finding public values but with some analytically and useful form to humankind. Although a survey was conducted in putting together the understudy policy it is observed that a merely invocation of an existing legislation (State Civil Servants Act 750/94) which does not necessarily fit or go far enough for such a reform.

To discuss value theory, Bozeman (2007; 2009) raises philosophical pertinent questions such as should values be judged in terms of intentions or outcomes? While discussing value neutrality and value judgment, he also noticed several varied scholarship debates on whether values-based actions be assessed based on actor's motivation (agent relative) or be based on the outcomes resulting from actions (agent-neutral). The latter is normally termed consequentialism or moral realism. Both situations of the motives and of the moral reasoning of the actors are necessary to understand actions and their outcomes [the approach to this study] making replication almost impossible (Bozeman 2007) but a good one for contextual analysis.

Anderson (1993 in Bozeman 2007) posits three criteria for consequentialist value theory as follows: 1) It assumes there are 'intrinsic values' (ultimate ends) and the human behaviour ultimately pursues these values; 2) Values and moral judgments are to be assessed only in connection with 'state of affairs' (that is, actual, not conjectural or ideal, but real-world

conditions). 3) Actions, motives, morals, values and individual character are important only in the ways in which they affect real state of affairs. But good intention is not an excuse for non-performance (Drucker 2008). In Anderson's diverse view to contrast consequentialism she adopts expressive theory to view moral behaviour not in terms of ultimate outcomes, which may be unknowable but in terms of the rational action they express.

Utilitarianism is acknowledged by Bozeman to be the best-known consequentialist-oriented approach to values. In this theory, value based is judged on implications for aggregate welfare maximization. It has the advantage over other approaches to value theory in that it can provide clear-cut prescription and has given rise to methods of calculations. Another advantage of the approach is that it provides important guideposts while avoiding problems if not dogmatic. A common downside discussed by both economists and philosophers is taking strictly the calculus could lead to absurd conclusions.

Concerning the relationship between intrinsic values and instrumental values, Bozeman advices, interest in public values must mean devoting special attention to the distinction between 'instrumental' and 'intrinsic' values; while noting, also, the different terminologies such as means and ends, proximate and remote and many more. Instrumental values lack value in themselves. They are valued only in relation to intrinsic values. Meaning, to the contrary, intrinsic values are ends in themselves yielding achievement to imply an end state preference. It is also observed that both instrumental and intrinsic values are agent-centred. This means the concepts by themselves rely on individuals' expressions of value as people do with legal tender/money. A further argument raised on both concepts as agent-relative is valuation. That means the act of valuing differs with individuals.

This agent-relative complexity of inequality and differences make sorting out instrumental and intrinsic values more difficult as there is multiple valuation of the same object. Bozeman deduces from the values and valuation argument two special difficulties for policy formulators and public managers. One is the possibility of conflicts among values. And the other, the difficulty in connecting instrumental values to intrinsic ones or related to real outcomes. Policy formulators [and implementers], therefore, need to learn to distinguish intrinsic from instrumental values and in matching potentially efficacious instrumentally based actions to likely outcomes. Implicitly, "forecasts from actions grounded in instrumental

values and directed towards intrinsic values are notoriously complex and often catastrophically wrong” (Bozeman 2007; 121).

Pollitt (2003) makes an important observation that only the rational value finds its way into economic models of individual and organizational behaviour. For example, in such a clash of rational and ethical issues, the Former Finnish Prime Minister is found in his 2006 presidential bid corruption charge (23,410 Euros). Accordingly, the criminal law findings and the subsequent Parliamentary discharge is perceived between (economic) rational and ethical judgementality put it as follows: Although the Prime Minister was “guilty of not disqualifying himself and of negligent dereliction of duty. However, the committee’s unanimous resolution was that [the prime minister’s] activities did not involve aggravated negligence, which is why the threshold for bringing formal charges against him was not reached (Helsinki Sanomat 2011)”. Flipped to the other side, the article pointed out that it would have been an inescapable fact for a civil servant or any other ordinary citizen. This reality serves ethical values and judgement in the instrumental and intrinsic values, agent relative and agent neutral discussion above; and, a great leadership by example. More importantly, the purpose of seeking the presidency by universal adult suffrage franchise and action have been compromised for the perceived dominant economic rational.

To empirical social science so long as intrinsic values are not agent-neutral vexes and reduces the field’s ability to inform. As the role of social science is not tied to instrumental values Bozeman concludes: All instrumental values can be viewed as causal hypothesis that are, in principle, subject to empirical tests. It is empirical social science’s program evaluation that fills in this vital role in determining if the connection between the two concepts, the serving instrumental value serves the implied intrinsic value.

Bozeman further discusses the justifications for public values and collective action. He argues philosophy’s core business is justifying public morality and less at justifying collective public values. It employs the approach of deontology and teleology to justify public morality; each having flavour on public value. Deontological justification centres on notions of one’s duty and in relation with the rights of others. In such justification action ought to be placed on moral code or a kind of principles. Thus public values qualify to belong, Bozeman argued. Unlike consequentialism, deontology avoids the path, the end justifies the means. Rather, it embraces critical situational ethics putting emphasis on principle dictate of moral decisions for a careful revision.

On the other, teleology: it is ends oriented but non-identical to consequentialism. Its ends orientation depends more on estimates both of common good and procedures from common good compared to any particular set of outcomes. Bozeman draws on the ideas of Rawls, Habermas, Gaus, Dewey and many others to account for the phrase: collective action is based on shared values. He then concludes that thence exist no competition among values or weighing of competitive values; for this reason, people act together simply due to their agreement of values. However its appeal, this approach may be problematic in larger and heterogeneous society.

Bozeman discussed Contractualism, an old time but still prominent approach to rationalizing collective action in society. Its chief question that still rages is “why should individuals band together and agree to submit to a moral code to which all are subject but in which any individual may in part disagree?” Bozeman perceives contractualism as agent-relative. But argues, if values are construed as totally neutral, so manifest or are learnable then little need is required of coordinated or agreed social contract. If it turns that values are agent-relative it means some justification is then required for certain individuals to put away their own values in favour of the larger community.

At length, Bozeman explains, [and there-in lies a plausible answer to the independence versus commitment and centralisation culture envisioned by Vision 2012] why one subjugates one’s values and self-interest to a community moral code instead of standing alone. That goes: if it is possible for one to achieve some sort of desired ends only by collective action, but the price of those ends is cooperation in ways that prohibits action toward other desired ends; then the rational calculation becomes the worth of what is achieved by collective action versus what is lost by submitting to collective moral governance.

Additionally, Bozeman expects a collective action to evolve following sufficient agreement on the returns to individuals in recompense for their allegiance. He explains further that in contractualism approach, one begins with real values held by individuals of the community, and seeks to understand the relationship as well as the commonality among individuals’ values. The end result being a contract of built from meshing out of values. Not only a potential and fundamental basis for a community moral code but, also, for a legal system or a

broader social contract is observed in this process, thus setting the basis for public interest or will (Lynn 2007; Blanning 2002; Olivecrona 1971).

Bozeman then takes a further step to establish his own Inductive Contractualism Approach that collective action is based upon existing shared values and social contractual recognition. It shares some features with both utilitarianism and consequentialism as explained above. It has a) no presumption of a greatest good for the greatest number calculus; importantly, b) the approach is voluntary and adaptive, relying on the actions of individual citizens; and c) the ‘consequential basis’ of collective action is not based on any particular outcome set but in a shared believe in the values forming collective action. In this wise, all societies possess identifiable public values. In certain situation these are done by aggregation, a process associated with the assessment of public policy and governance. One can evince from this Inductive Contractualism to be anchored on ‘Will’, particularly, talking about voluntary adaptation. This process must be based on mostly face-to-face quality discursive communication (Habermas 2008) and implementation.

“Will” is found to be the core of both theory and practice of law from antiquity to modernity; [also, Utility and satisfaction theory in Economics (Bonner 1986)]. The author of *Law as Facts* observes that natural law assumed that all people are by nature free and, therefore, equal. In that assumption, Olivecrona finds a great problem to explain Will from the legal perspective. The argument advanced in that respect is that when people live in society under law that automatically restricts their freedom; it also implies inequality by the process of societal organisation. The questions raised from his analysis were how do the original freedom and equality reconciled? And, how could such free and equal people bring upon themselves such limiting forces of restraint and subordination? Olivecrona explains by first dealing with the double meaning of freedom to be “absence of actual, outward restraint.” The other “was a moral concept that involved freedom from obligation. But an obligation was an inner bond on the will. Freedom from obligation therefore meant an inner freedom. No human being possessed by himself the power of imposing an obligation on another. Every man was, under God, a sovereign to himself. His realm, his inner freedom, could not be touched from outside” (pp. 11-12).

In the likewise and from different perspectives, Bozeman (Value Theory – Public Policy) and Olivecrona (Will Theory – Law) demonstrates the need for a social contract among people and by individual voluntary submission. This forms the basis for mutual consensus for

society formation and basis of governance. The individual by their own volition might have promised and declared their intention to take part in a society and to obey orders from the authority created from the mutual consent. But the obligatory force from the mutual promise cannot come from the will of the people involved alone. Olivecrona found there must be a rule that hovers above “the sovereign individuals that have the power of putting restraints on their inner, inviolable freedom. This is the rule of the law of nature. In the law of nature the source of the binding force of a promise is supposed to be found. The social contract is the mother of positive human law, Grotius says, and the law of nature its grandmother (pp. 13).” Systems such as the judicial or administrative governance of a society have not one single driving force but the regular application of efficacious rules and a network of psychological and material factors such as ideas of rights and duties, habit, belief in authority, fear of sanctions and many more [go to establish the basis of democracy]. The will theory substitutes an imaginary will for this infinitely complicated reality (Olivecrona [1939]; 1971).

This complication arising from individual and group/societal Value-Will relationship is viewed as the fundamental basis of democracy and governance; thus freedom with self-imposed limitations or rule of law as commonly put. Taking the latter as the individual or group/societal “process of decision-making and the process by which decisions are implemented (or not implemented)” (Sheng 2011; 1; see also Hill and Hupe 2002). Sennett (2008) agrees the basis of self-governance is the desire to do qualitative work for one-self and society. Therefore, good governance to Sheng implies: “it is participatory, consensus oriented, accountable, transparent, responsive, effective and efficient, equitable and inclusive and follows the rule of law. It assures that corruption is minimized, the views of minorities are taken into account and that the voices of the most vulnerable in society are heard in decision-making. It is also responsive to the present and future needs of society”. Good governance as pointed out earlier and its eight major characteristic values – remember EC 5; Nokia 3, Vision 2012 10 and compared with the precept of management 4 (see section 3.4.4) - turn to be rare in institutionalisation achievement by any nation (Sheng 2011; Peters 2001; OECD 2001). Good governance remains scarce.

The value reality picturesque noticed earlier may demonstrate a global phenomenon as hinted in a common complaint of the OECD holding that member countries lack dedication to the underlying values of public service and the interests of the citizens. Governance can be seen as the way in which the underlying values of a nation are institutionalized; formal aspects or values such as separated powers, checks and balances, means of transferring power,

transparency, and accountability become worthy of the leadership; however, their actualization must guide the actions of public officials throughout the system and must be imbedded in culture; a common response seems to be the attempt to promote a certain kind of leadership in the public sector (OECD 2001). At the time of this observation the reform fashion was thought to erode public values and ethos of the public administration (Rhodes 1997; Bozeman 2007). The NPM is a shift in value priorities away from universalism, equity, security and resilience, and towards efficiency and individualism (Hood 1991 in Pollitt 2003; 28; Taylor 2001). The NPM reforms practices in both developed and developing world fail to escape this web with ethical misconduct and corruption (Bozeman 2007; Pollitt 2003; Polidano 2001).

Good governance, therefore, should reflect a mix of [individual-]societal interest, public values and economic, Bozeman concluded. Refusing to dismiss economic individualism makes Bozeman's work more realistic and applicable than others and it should be considered as effective in discovering what is important in public policy making (Kerkhoff 2009), and implementation. But public value interpretation could go anyway as in decision-making process (Bozeman 2007; Simon 1997).

Bad governance, for example, was introduced in American public administration under President Andrew Jackson (1829-1837) for introducing the spoils system. That is, when the efficiency of the American system had been found to favour the educated stratum; the president interpreted this to be contradictory to the egalitarian principles of the republic; and, contended winning parties were entitled to install their followers in government offices; the new system, institutionalised promotes incompetence, corruption, weak policy implementation and bad governance generally (Manheim 2009). Riggs (1994) acknowledged all the maladministration of abused and transients dominance which led to the enactment of Pendleton Act in 1883. Following this parochial electoral interest-group democracy arrived onto the scene in the 1960s was 'the new public administration' with its correction concerns being "values, ethics, morals and the relation of the client to the bureaucracy" (Koven 1994; 82).

However, from a broad perspective, the natural community tendency is to develop ideologies, the dependence of institutional values on the formation and sustaining of elites, the existence of conflicts expressing group interests illustrates its elements that combine to form the social structure but with a unified effect; nonetheless, in the natural community and organizations

elites play a vital role in the creation and protection of values as it is a practical problem of first importance, especially, for those seeking special identity (Selznick 1957). In the American case, Hecló (2000 cites Halligan 2003) found lack of a voice to champion higher civil service values. Halligan notes that the system is without the institutional leadership that ensures the infusion of values and a sense of worthiness in its daily operations.

In another setting but related development, New Zealand adopting the NPM market type approach has since 2001 rescinded her decision to relinquished responsibility for cultivating the senior civil service by wholesale devolvement to agencies (Halligan 2003; Fukuyama 2005; Christensen 2008). Even where there is one in charge as the Head of the Civil Service they fail as leadership by example; and, in their duty, as an attempt to be responsive to the political master (Halligan 2003). These two examples could have direct repercussion for the Finnish Public Administration as at least somebody must be responsible as the pivot for the centre to build the institutional leadership, values and loyalty, capabilities and other organisational and personnel needs. In such a process, the total environment and sectoral relationships must be considered for unity of purpose. This is the anchor of the study model and the study itself.

3.3 Reforming Cultural processes

Dingwall and Strangleman note Western corporate entities in the early 1980s were encouraged to move away from bureaucracy, but change their cultures and adopt new styles of management based on leadership and inspiration. Amid this fuss of rational management was a mere change of the 1950s vocabulary and symbols of legitimating for the manager. The rational manager's "own goals and values remain as unexamined as those of traditional corporate bureaucrat" as well as the non-alignment of the manager's toolkit and the consent of the governed (Dingwall and Strangleman 2005; 473-4).

Culture change may not necessarily be the goal (Schein 2004). For example, a look at Finnish Nokia established in 1865 and ever since lacking internal communications not until recently despite being a communication technological entity; and, one of the best global companies since 1998. Internal communication has been forbidden in Nokia until liberalized in 2006, with the chief executive having an own personal blog following a looming strike over

bonuses (Hakkarainen 2009; 184). Bonus sharing a non-traditional matter and its resolution from Leadership by example has changed the centenary and half culture without even a mention of it. Therefore, defining the culture change problem is the most challenge; some of his consultancy projects got stalled when insistence was put on the question, what of the culture to be changed or reformed (Schein 2004)?

Leadership and culture are two sides of the same coin observes Edgar Schein who touts deeply the leadership-culture relationship as an evolutionary perspective that cultures are born to groups by the imposition of their leaders' own values and assumptions. By his definition culture turn to be "a pattern of shared basic assumptions that was learned by a group as it solved its problems of external adaptation and internal integration, that has worked well enough to be considered valid and, therefore, to be taught to new members as the correct way to perceive, think and feel in relation to those problems". Schein's concern is the "ability to perceive the limitation of one's own culture and to evolve the culture adaptively is the essence and ultimate challenge of leadership" Schein (2004; 2). To Mintzberg (2009), culture is a tool of control and decision shaping in the leading process with the manager in the centre as its energy as well very easy to destroy than to build a culture.

Cultural history is on the rise and its concern is about its revelations as it scrutinises texts, pictures, and of actions with open-mindedness (Hunt 1989). While this study is seeking to discover the cultural roles and meaning to public management reforms elsewhere the encouragement is strongly made (Hunt 1989; 22): "Historians working in the cultural mode should not be discouraged by theoretical diversity for we are just entering into a new remarkable new phase when the other human sciences are discovering us a new". In a microcosm of the Finnish public administration this theoretical diversity discovered a new: It was observed at Vaasa University in November 2009 at the annual conference, "XXVIII Hallinnon tutkimuksen päivät" (Finnish Association for Administrative Studies Research Days). The Honourable Minister of Public Administration and Local Government interacted at the conference. Having delivered her speech, only 3 professors threw questions at her and silence befell the rest who hitherto were active questioners to their professors.

In seeking cultural roles and meaning from this episode, Professor Katajamäki who had argued for researchers to advance from mere explicators of issues to being active change agents later explained in an email that "In Finland, there is a tradition to avoid not embarrassing yourself in front of people with authority. From juniors point of view there were two kinds of authorities present: the

minister and the professors. They dared not to open their mouths.” Two sources of confirmation for this assertion came from Professor Risto Harisalo and 6 of the juniors. The tags included the “Finnish silence” and “respect for authority”. Others were “the minister’s speech did not impress to attract a reaction”, “power”, “hierarchy”, and “it didn’t concern me”. Revealing here is the strong presence of hierarchical traditional structure, culture and status maintenance although in modern society as well as generational and communication gap between them.

Schein’s evolving culture adaptively depicts the process aspect of culture featured in this microcosm rather than its all-time viewed as static character and product. Culture is practice vital to all aspects of social life; it is embodied, engaged, interactive, creative, and contested (Calhoun and Sennett 2007; 5). Calhoun and Sennett found culture is a study of values not valuing thereby missing on culture processes. Take for example: Nokia’s global challenge of continental cultural differences has been successful by its socialization processes. Hakkarainen attributes this to three factors namely, the Nokia Values, the Nokia Code of Conduct, and Investing in People (IIP). Both the human resource department and managers are very active on these. Evidence of the chief executive’s active involvement and befriending the factory floor staff and lately communication improvement despite some difficulties were also reported as part of the cultural success processes (Hakkarainen 2009).

Note that culture is a collective process of sharing (Mintzberg 2009; Morgan 2006; Schein 2004). The Nokia story is an administrative process that is centralised and shared. Inferred, centralization is measured as both the hierarchy of authority and the degree of participation in decision making (Andrews, Boyne, Law, & Walker 2007; Simon 1997) not geographical (Simon 1997). Historically, Argyle (1994) recalls the first modern nation states (England, Spain and France) succeeded based on effective leadership and administrative centralisation culture that has continued to persist.

From the manager and leading point of views, Mintzberg’s (2009) assertion is that we are over led but under-managed. The Former British Prime Minister demonstrates in his memoir the sense of frustration and, indeed, his greater sense of urging courageous leadership in Europe generally, with new brand of politicians and civil servants akin to the private sector (Blair 2010). Both researcher and practitioner views create a mixed situation on this matter. But the question is how far has this private sector emulation hype gone with the private sector itself considering recent events such as ‘controversial’ bonuses (Pfeffer 1997; Mintzberg

2009) challenge to the bankers, to the people and government; corruption and the 2008 World recession/market failure engineered from Wall Street (Obama 2011; Galbraith 2004; Stiglitz 2009; Herbamas 2009). These are the primary determinants of historical realities of *mentalités*: for economic and social relations are the determinants of culture; but are themselves fields of cultural practice and cultural production (Hunt 1989; 7). It depicted that deemed important values and relationships of the time. This history of *mentalités* establishes culture as a force of change over the long time held socioeconomic factors (Desan 1989).

Eddy (1983) and Lynn (2003) already reject the idea of the management school reform or NPM as it caters not for the public manager and the system's problems. This study will argue strongly that the public manager requires no emulation but its own visionary, proactive, adaptive management for leading realities of the current settings and from the future. President Obama, for instance, observes "The Time for Our Leadership is Now" (Obama *ibid*).

3.4. The Management Development Process and the Government Manager

3.4.1 The manager job

To Mintzberg, the structure of an organization is defined: as the sum total of the ways in which it divides its labour into distinct tasks and then achieves coordination among them. Coordination, he argued, is complex and variegated: coordination mechanisms are concerned with control just as communication is with coordination. Mintzberg's five coordinating mechanisms are mutual adjustment, direct supervision, standardization of work processes. Standardization of work outputs, and standardization of worker skills. They form the most basic elements of structure, *the glue that holds organization together (emphasis original)*. To this effect, the institution serves its mission in an effective manner depends on the strategic apex and middle level manager's effective line of coordination mechanism to the operations management level (Mintzberg 1979; 2-3).

Similarly, Dunsire's management three levels are top, middle and 'shop floor'; it is also cognitively, hierarchically and horizontally structured; furthermore, it is linked by inherent Weberic rules and rights; celled of specialisation ranging from low-narrow-specific to upper broad-general: the top management or strategic apex where the subject of this investigation

comprises of political and legislative as well as managerial levels in a government department/ministry. In another view it is functions at the top and processes at the lower levels (Glombiewski 1983). Whatever job/function is dish out from the top must be coordinated back to its starting source ensuring goal achievement (Selznick 1957).

As pointed earlier while the civil servant is expected to earn promotions and be appointed upwards, the political master is elected to the top of the hierarchy. Traditionally, the line of ascent was nobility by birth as history demonstrates (Lynn 2007; Aarrevaara 1999). Similar to European rulers, Aarrevaara notes Emperor Peter the Great of Russia in 1772 created the Civil Service system with 14 ranks consistent to the then existing European Public Administration of the Seventeenth-Eighteenth Centuries to his non-noble by birth advisors. Lynn found the German rulers of the 1640s Fredrick Williams' dynasty ushered in the absolutist state to institute public management by trained and competent civil servants acting on behalf of "public interest or public will" (pp. 31).

In this European eighteenth century landmark cultural change different regimes approached the reforms with different strategies and processes to their successes or failures. In this accent of public sphere opportunities and challenges what matter is "the realisation – however late, unplanned or imperfect – that new circumstances required a new political culture". Understanding culture and power or having an idea and army or the combination saved Joseph II of Austria, George III of insular Great Britain and Fredrick the Great, of Prussia but not the French Monarchy and the resulting French Revolution of 1789 (Blanning 2002; 441). Therefore, having an idea, understanding culture and power are necessary for any reforming Leadership.

Tim Blanning (pp. 430) is not pleased that little is published of Joseph II who might have done most in this absolutism transformation process in Europe. At age twenty, Joseph had better modernised the ideological bases of his rule having demonstrated in his very first political memorandum 1761 proclaiming: "Everything exist for the state; this word contains everything, so all who live in it should come together to promote its interests". Two decades later, he again wrote to demonstrate how he had "lived as the servant of the state". Joseph's tirelessly servant working, Blanning describes, as "what can truly be called a vocation, constantly travelling along the length and breadth of his dominions and eventually working himself into an early grave"; and, in fact, duly dying on the job (pp. 431). Blannings concern reveals even more relevant issues for today's republican managers: thus job description, unity of purpose, activism and commitment.

Cameralism was the new public sphere management and practice. It advocated for meritocracy, administrative science, standardised principles, formalism and professionalism; these led to the attainment of successes for the practitioners to be described as ‘Consultant Administrators’ and, yet unsurpassed (Lynn 2007; 31-2). Education, training, examination and selection, evaluation of civil servants has since become prominent (Lynn 2007; Aarrevaara 1999). Lynn’s adumbrations showed ancient China inculcated into future civil servants desirable values and attitudes of government even before Christ.

The functions could be summarised as widest horizons; policies, objectives, evaluations; obtaining resources or foreign relations (Dunsire 1990). Further detailed top managerial roles according to Mintzberg are direct supervision: which includes resource allocation and designing the organisation structure; staffing, assignment of people and resource to tasks, work orders, the authorization of decisions, conflict resolution, exceptions, monitor, review of employee’s tasks and activities, transmission of information, leader, motivating and rewarding employees. Direct supervision implies ensuring the entirety of the institution running smoothly as a single integrated whole unit. The next set of managerial duties are involved with the management of the boundaries of the organization where managers are spokes persons informing who matter in their environment; liaison in developing high-level contacts, monitor to tap relevant information; serve as the contact point for influence of the organization. The manager is the negotiator with outside parties; figurehead in carrying out ceremonial duties.

The rest are the development of the organization strategy, the mediating force enjoining the organisation and its environment. This formulation process depends on the interpretation of both the environment and the development of consistent patterns in streams of organisational decision to deal with it. This means understanding the environment and being responsive by aligning the needs and strength of the organisation’s mission – the strategy. Mutual adjustment is recommended for managers for strategy development at the organisational apex; but where it fails direct supervision is necessary (Mintzberg 1979).

In Druker’s (2008; xi) words the very best leaders are first and foremost effective managers. Recalling from above the theory of structure, Mohr (1982) notes that both direct and particularly oversight supervision are necessary for organisational successful management.

The failure of a manager then is the inability: to make and communicate the right decisions through the organisation (Simon 1997); to glue (Mintzberg 1979), the delegated parts (Mohr 1982; Fukuyama 2005), and poor management of the social world pressures that results in the lack of self-control (possibly due to rivalry, egotism, competition, etcetera; Selznick 1957; or harbouring divergent and ubiquitous values (Bozeman 2007; Mohr 1982); leading to Hansen (2009) and Bardach's (1980) management and implementation barriers development – of fear, unwillingness, weak capabilities, lack of sharing and working together, and so on – resulting in the development of hostile environment with less free and open Implementation Communications. It is also thought to be a not today's problem but begun in the doldrums of the past as a result of Peter Principle or incompetence (Peter and Hull 1966; 2011). As a consequence, an effective manager, the anchor of organisation is a rare commodity and a core component of the scarce governance process; and, must be sought for vigorously.

3.4.2 Management and the public manager

Manager development has been well in progress for the private sector since the 1950s (Drucker 2008). It was in the 1980s when governments got the awareness (Tiihonen 2004) as a result of the NPM reforms; and later in the 2000s the United Nations and Institute of Public Administration got involved (Rosenbaum and Kuanz 2006). Consequently, the Finnish Government is seeking to switch off from expert leading to “professional management” (MoF 2012; 11); although a non-existent but understandable concept, as management is non-codifiable (Mintzberg 2009). But it is assumed consistent with Keeling's (1972; 32) generic management: “The search for the best use of resources in pursuit of objectives subject to change”; while basing his choice of definition on its history in British civil service, he also factored the USA first ever usage of the word by the Brownlow Presidential Committee in 1937; That “Good management will promote in the fullest measure the conservation and unitization of our national resources and spell this out plainly in social justice, security, order, liberty, prosperity, in material benefit and in higher values of life”. This USA version he described over statement but with under-explanation (pp. 18).

Management is “combining the many techniques and personal skills and putting them into action”; it is applied, pragmatic, inexact, and semi-rationally (Eddy 1983; iii); to attain successful implementation. Agreeably, the manager's job is fragmented and in constant flux; “[m]anagement is not one of these things but all: controlling and doing and dealing and thinking and leading and deciding and more, not added up but blended together” (Mintzberg 2009; 44); Mintzberg argues

further that management is neither a science nor a profession; as a little of it is reliably codified; it is a practice learned primarily through experience and rooted in context.

Keeling (1972; 18) recalled of “management” to denote the concept’s first ever usage in the British public service core was to depict the reality of a weak and incompetent government/public manager, thus: “I am sure that members of the administrative class are not sufficiently alive to the great responsibility which they should carry in this management matters.... They alone can insist upon – and personally secure – maximum efficiency at every level, cost consciousness all along the line, and effective communication within the organization and those we serve”. That was from the 1957 Treasury circular by the Head of the Civil Service.

It is important to note, however, that elsewhere and about the same time the Peter Principle in Management was first published observing: “*In a hierarchy every employee tends to rise to his level of incompetence*” (pp. 22). Its Corollary states: In time every post tends to be occupied by employee who is incompetent to carry out its duties; by virtue of promotion from competent to incompetent final level; therefore, work is accomplished by those employees who have not yet reached their level of incompetence to keep the system going (Peter and Hull 1969; 22). This is consistent with Mintzberg’s (2009) middle management or Caiden’s (1994) middle level management creating jobs for themselves as the bosses look elsewhere. This explains not only the British weak and incompetent public manager/administrative class but together with Mintzberg’s (2009) earlier declaration of all managers as incompetent might take the problem back and far into history of management and administration to Lynn’s (2005) successful Administrative Consultants of the Cameralists. The public management problem cuts across fields as such require multi-skilled manager and politician working with the expert. In the review the manager is found incompetent. The expert is obsessed and the politician fails to set the connecting values. The community or the governed has been left out.

3.4.3 Manager Development and (Reform) Processes

In this section four different models (A-D) of manager development processes are discussed. They are followed by feedback processes for consolidation (5):

A. The OECD identifies developing future managers/leaders to be based on i) identifying potential leaders, ii) defining and measuring leadership competencies or doing succession

planning, iii) encouraging mentoring and training, iv) providing incentives to link performance, v) time allotted for such purposes and, vi) ensuring sustenance. The approaches for developing these public managers/leaders draws into the picture specialized institutions of Management Development such as the recently established (in the UK), renewed institution (in Norway), or new institutions (in Sweden, USA) or improving existing facilities (Finland) for leadership identification and development.

The report continues that key management development tool seems to fall on training, and networking. Iceland adopts an innovative approach that involves the government assisting leaders to organize and maintain networks among themselves as well as coaching and counselling. Countries such as Austria, Belgium, Finland, Japan, Korea, Netherlands, Poland and Portugal established new training courses for the top executives or senior managers (OECD 2000). The Drucker (2008) Model of management development stands opposite to this model (see pp. 81-2).

B. Collaboratively, effective people management should be based on technical knowledge, thoughtfully and systematically analysed and pursued actively. That means following the *systematic approach* of Schuler and Jackson (1996; 24-7). The approach has four defining characteristics: 1) by considering the different practices for managing people *together* affect attitudes and behaviours of the different employees; human resource policies and practices (including appraising) consistent with each other and coordinated with each other to communicate the same message to employees. 2) Employing the unique characteristics of the organisation such as its history, top management goals and strategies, corporate culture and so on. 3) Following the constant environmental changes, example, the economy, labour market and laws. 4) The process of trial and error drives the systematic approach based chiefly on information and data from start to end; these information and data are collected pre-changes, and decision to be based upon that; monitored and adjustments; at end of process data are used to measure and evaluate the outcome and impacts. This is something not found in the Vision 2012 policy booklet (MoF 2003).

C. Self-study; and, D. Structured experiential learning are other sources of manager development. Van Wart explains the former as where one's consciousness is raised before, during and after either developmental experience or formal training; arguing that without self-study or self-recognition of the issues and skills of leadership no such developments will

take place. Similarly Colvin (2008) argues knowledge is useful only when recalled at the appropriate time, place and applied. Autonomously, self-study is learning that occurs outside formal training and structured developmental experiences provided by the organisation (Sennett 2008; Colvin 2008; Schein 2004). They observed continual learning skill is very necessary for self-development. Three enhancing elements that influences experience development: work challenge or realistic assignments; critical variety of experiences; and the quality of feedback add up to make enormous difference and change (Van Wart 2005).

Feedbacks are variably and formally multisource: workshops, developmental assessment centres, special assignments, job rotation, action learning, mentoring, personal growth programs, executive coaching, and outdoor programs are other sources (Yukl 2010; Schuler and Jackson 1996). Lynn (2003), Yip and Wilson (2008) consign case studies fulfils the gap of leadership development better. The later further advocates challenging assignments, developmental relationships, adverse situation and coursework are the key drivers for leadership development. Above all, the design of the curriculum is seen more crucial than the implementation (Van Wart 2005). For example, Yip and Wilson (2008) found in Singapore leadership study where a mere 11% (N 36) cited their effectiveness emanating from coursework and training. MBAs are not recognised as manager developers (Mintzberg 2004; 2009). Yet, Pollitt observes public managers acquire that or other generic management training courses in which case specific and peculiar to the public service are scarcely covered; calling it a mere “skill module” learning (Pollitt 2003, xii); or management fads (Drucker 2008).

All these vindicate the rational ethical manager’s problem still not identified but perpetuated despite the criticisms and over-elaborations from the different angles including the politician and the expert. Going through all these and the NPM requirements have failed to transform the European public manager into a leader (Thiel et al. 2007). But outside Europe one can find the success story of Singapore’s leadership development scheme which has produced successful managers in all the sectors (Yip and Wilson 2008; Loong 2009; Haligan 2005; Jones 2002). Worthy of notice is while the Finnish leadership development starts from the very top; the Singaporean is from the very bottom and across sectors. Obviously methods of implementation would vary but active communication would match either for effective manager development. Who is the public manager then?

Refreshing the mind with the manager's roles discussed already, take a walk through this book *The Essential of Public Manager*; in there, Pollitt (2003; 18) distinguishes the public manager to be:

- Managing in a socio-political system
- Working with public pressure and protest
- Having a sense of accountability
- Understanding public behaviour
- Involved with management of ration
- Concerned with management of influence
- Assessing the multi-dimensional performance
- Understanding a wider responsibility to a changing society

Also, some criticisms were labelled as (pp. 86-7):

Civil servants do obstruct the wishes of their political leaders, because they have agendas of their own (the '*conspiracy theory*')

Civil servants do block the wishes of their political leaders, not because they want to, but because they are trapped in bureaucratic routines which make them slow and unresponsive (the '*bureaucratic theory*')

Civil servants appear to block the wishes of the political leaders but, that is, because what they are actually doing is pointing out real and substantial obstacles to or flaws in the politicians' plan, problems which the politicians had been too ignorant or ideologically committed to see for themselves (the wise '*counselors theory*'). When politicians blame their civil servants they are really (and unfairly) shooting the messenger because they don't like the message.

Civil servants don't block the wishes of political leaders. The latter make up negative stories about bureaucracy to excuse their own failings, because civil servants are in no position to answer back (the '*scapegoat theory*')

One may find that due to the silo-slab structural constraints the criticisms above bite the public manager even more. Bureaucracy is a specialist's institution in principle; and, public policy will continue to need expertise and non-technical expertise such as administrative related to the problem of implementation and circumvention (Meier and Hill 2005). Lynn's (2003) account of recent events of public management is largely perceived as focusing on public administration as a profession and on the public manager as its practitioner. Combining Mark Moore's views which he termed as comparatively new, public administration is conceiving and implementing public policies that realize the public values of a given political and institutional setting. The public manager crafting through the processes to success that Lynn's (2003) synthesis of the older and the more recent craft

oriented literature to form the basis for the structural, craft and institutional aspect of public management.

3.4.4 The Craft perspective and process

The public management as a craft perspective (Lynn 2003; Shafritz and Russell 2003; Moore 1995) defined administrative responsibility as primarily a moral question or, more specifically, as the resolution of competing and conflicting codes, legal, technical, personal, professional and organizational, in arriving at individual decisions. A quotation Lynn recalls from Millet who notes obstacles are inevitable to any administrator in understanding and seeking solution to problems to exemplify the crafting states: “In a democratic society this question is not guided solely by the administrator’s own personal sense of desirable social ends. The administrator must convince others as well. He must work with interests groups, with legislators, with chief executives, and with the personnel of his own agency to convince them all that a particular line of policy or program is desirable” (Millet 1954; 401). Unlike in common practice, craft study must focus in specific settings what managers did or should do while taking into consideration its structural elements too, (Lynn 2003).

Leaving it at the necessity level for public managers to master their craft in order to affect public management, Lynn turned to discuss its institutionalism as it has to do with this craft. Two long standing traditional values of self-control of the public manager and the self-regulated institution bring to the fore the concept of responsibility. To Mosher, be it public or private administration, responsibility is the core word of all its vocabulary [the politician, expert and the rational ethical manager’s base problem is defined]. The structural and craft responsibility perspectives denote: objective responsibility or answerability for one’s actions is the structural perspective whereas the craft is subjective responsibility which is similar to identification, loyalty and conscience (Mosher 1968 in Lynn 2003). Bertelli and Lynn found four classical distinct and demonstrable qualities or values namely; accountability, judgment, balance and rationality. Lynn argue these values constitute a *precept of managerial responsibility* in that when observed in managerial practice, justifies judicial deference with agencies being the defendants in litigation and, therefore, qualifies as a general norm of responsibility (Bertelli and Lynn 2001 in Lynn 2003).

Not only this study but the OECD defines public sector manager and leadership problem as: *How to develop public officials who can draw others into a strong spirit of public service geared to the needs of contemporary society, and thereby make their services to government and to citizens more effective* (OECD 2001; 12; emphasis original). Implying as discussed above that the leadership's political views in the administration need not to be broadly divergent to that found in government and society (Tiihonen 2001, 2004). Similarly, Lynn (2003) notes Morstein's argument on blending the public manager's consideration of the legislative, executive and public reaction concluding: "Ideally, political and administrative thinking should blend into a joint process (1959; 102)"; or 'adjustive activity' to signify public management is the continuation of the political process of adjusting public interests (Redford 1969; 188 in Lynn 2003). Public values must be imbedded in culture and 'leadership' is the flesh on the bones of the Constitution as well as being at the heart of good governance (OECD 2001; 1).

Fukuyama contends state-building is the creation of new government institutions and the strengthening of existing ones to execute its numerous functions. It is observable of the ongoing EU area economic, political and cultural integration wrangling at the start of the twenty-first century. Three factors account for the Stein Rokkan (1999; 130) conceptual map and centre-periphery path development analysis of nation-state building in the European Empire from the era of Roman Empire or eleventh to the eighteenth century is evident to that termed "the success of the centre building": First, the development of literate bureaucracies and legal institutions (military-administrative), not without the Church and dynasties cooperation (cultural); second, trade and new industrial growth and development (economic); and, third emergence of national script as well as the resulting attempt at unifying the peripheral territories culturally around a standard medium of communication enhance by the new technological printing press (cultural). To consolidate the market and control achievements behind, Rokkan observed further that events are different fundamentally after the nineteenth-twentieth centuries; to include the building of national identity, administrative unification, democracy and participation or mass politics establishing the basis of universal adult suffrage.

In such process policy affects merely the periphery of culture and structure. "We are defined by values that are static, immovable, not subjected to the ravages of time; rather than by policies which necessarily are ravaged and altered" (Blair 2010; 684). These are shaped by education, leadership and

interaction with other societies (Fukuyama 2005). As Pfeffer (1997; 120) infers commitment is one tool that strong organizational culture could be built with but requires willingness of the employees. Elaborating further, Morgan (2006) argues the challenge of culture change is a challenge of transforming the mind-sets, visions, paradigms, images, metaphors, beliefs and shared meanings that sustains existing business realities and creating a detailed language and code of behaviour through which the desired new can be lived on a daily basis. In that respect, this involves the creation of shared systems of meaning that are accepted, internalized and acted on at every level of the organization (Morgan 2006; Schein 2004; Bozeman 2007).

The challenge is for managerial leadership of politico-administration to blend both bureaucracy and network as useful instruments for policy development and implementation using their formal and informal aspects (Dingwall and Strangleman 2005); more importantly, the formal hierarchy connecting to the informal purposeful networks (Pettigrew et al. 1992). In the governance process, the post-NPM project “joined-up government” (JUG) or a “whole of government” approach demands and interactive approach (Blair 2010; Peters 2006; Christensen 2006; Rhodes 2006; Pollitt and Bouckaert 2004) of negotiations management to build and keep trust (Rhodes 2006; Bardach 1980).

Similarly, a well-managed culture develops decentralisation based on trust (Mintzberg 2009). In this costive and time consuming process the public manager must have “strong interpersonal, communication and listening skills; ability to persuade; a readiness to trade and to engage in reciprocal rather than manipulative behaviour; an ability to construct long term relationships” (Ferlie and Pettigrew 1996 in Rhodes 2006; 432-3). Dunsire (1990) has argued both communication and rights are inbuilt in the Weberian bureaucracy. Therefore, the efficient voice channelling and the interaction between external and internal boundary building strategies of an organisation depends on its history and territorial system that it belongs to as well as the policies pursued (Rokkan 1999).

Noticeably at this stage of the review are parsimonious prescriptions scattered in this report capable of constituting a needs assessment model of the rational ethical manager having already posited the possible failure above (see section 3.4.2). Van Wart recognises that “the executive development is the most conceptual, as well as the broadest and most externally oriented type of training [and education]. Programs for executives tend to focus on the role of the organisation in the public

sector environment and to facilitate the executives' skills in coping with external opportunities and threats" (Van Wart 2005; 400). From Selznick (1957), the apex competent rational ethical manager should be a statesman; an institutional leader by being able to distinguish the managerial tasks from the institutional needs to define his/her expected attitude and behaviour. The candidate must have the, will to lead and develop – self, others and institution - (MoF 2003). Thenceforth, be characterised by being, broad minded (Pollit 2003; Van Wart 2005), possessing organizational scientific knowledge and defender of values (Selznick 1957; Bozeman 2007; Bass and Riggio 2006; Shafritz and Russell 2003), policy and managerial skills – 3Es of economy, effectiveness and efficiency - (Rhodes 1997), and leading change skills (Pettigrew, Ferlie and Mckee 1992; Kotter 2002), responsibly (Lynn 2003).

As a result communicating effectively (Hackman and Johnson 2009; Yukl 2010; Simon 1997) or communicating all around (Mintzberg 2009); and coordination for coherence (Peters 2006; Pfeffer 1997) based on public value and interests (Bozeman 2007/9; Lynn 2003; More 1998). The manager must be crafty, artistic and scientific (Sennatte 2008; Mintzberg 2009; Lynn 2003; Drucker 2008) to manage upwards and downward (Moore 1995); of course remembering the lateral/horizontal colleagues; and, more importantly, the manager must be committed (Pfeffer 1997) and be part of the collective commitment (OECD 2010), not without the connecting skills, and consent of the society via both formal and informal ways (Dingwall and Strangleman 2005; OECD 2001/10). The manager requires enormous authority (Simon 1997) to effect change and purge obsolescence (Drucker 2008). Leadership is lifelong learning matter (Yukl 2010; Hackman and Johnson 2009), and so must its systematic developmental processes too (Schuler and Jackson 1996). This manager innovation model (Loveless and Bozeman 1983) is based on training/education, leadership and external interaction (Fukuyama 2005) conceptualises results such as changes in skills, attitudes, feelings, behaviours and knowledge (Patton 2002) for better implementation and performance action.

3.4.5 The Elusive Management Development Process

"The executive becomes a statesman as he[*she*] makes the transition from administrative management to institutional leadership" (Selznick 1957; 154). Selznick's conclusion was made having waded through his sociological interpretations but first taking cognisance of the illusions of crafting in his opening paragraph. It reads: "The nature and quality of leadership, in the sense of statesmanship, is

an elusive but persistent theme in the history of ideas. Most writers have centred their attention on political statesmen, leaders of whole communities who sit in the high places where great issues are joined and settled. In our time, there is no abatement of the need to continue the great discussion, to learn how to reconcile idealism with expediency, freedom with organization” (Selznick 1957; 1).

Per this analysis so far, it may be wrong albeit a common notion that the private/business sector is urged to learn this statesmanship and building reserve currency for the future: thus acquiring political skills while assuming the public manager is already in possession which may not also be the case. In Israeli business community, for instance, the importance of good political connections is favoured over the expertise at the apex of the organisation and perceived as managerial success and advancement (Pfeffer 1972). Bower and Weinberg (1988) claim that the constant source of fascination and inspiration of the art and craft in the mobilization of human effort is missing out of much of the contemporary American business literature on the leadership, particularly, in its treatment of the political dimensions of managerial competence. Bower and Weinberg’s argument is that successful leaders build reserve currency of influence required in time of change or redirection of their organization. Such leaders speak of purpose through the medium of non-market organizational activity; and they use the organizational system both to build the coalition’s necessary to pursue agreed-upon goals. The researchers conclude: statecraft is the vehicle through which strategy is managed; and its practice, rather than being destructive and manipulative, is a benevolent and essential component of the job of leadership of the firm (Bower and Weinberg 1988).

Statesmanship with political skills may be one of the many faces of crafting. Crafting depends on how one is socialised into a community or organisation (Sennett 2008). Both theory and practice view the people resource selection, training and socialization is the important parts of the organizational control process (Pfeffer 1997; 101). In Pfeffer’s view culture, language, commitment and socialization processes form of control are thought to be preferable to external controls such as reward and sanctions. Now, a brief on socialization: Pascale [1985] defines socialization as the systematic means by which firms bring new members into their culture (Pfeffer 1997; 118).

Pascale’s processes of socialization are as follows: 1) “careful selected of entry candidates”, 2) “humility-inducing experiences in the first months on the job” – the goal of socialization, 3) thorough training through exposure in the field to the organization’s operation and to

individuals who exemplify its values, 4) socialization experience entails paying close attention “to systems measuring operational results and rewarding individual performance, 5) strict adherence to organization’s core values, 6) developing reinforcing folklore, stories, and legend that validate the organization’s culture and its aims and that interpret history in ways consistent with its values, and 7) “consistent role models and consistent traits are associated with those recognized as on the fast track” that is, consistent behaviours and attitudes valued by the organization (Pfeffer 1997; 118-20). Such is the processes crafting adopts (Sennett 2008), a systematic manner of competency building via strong socialisation.

From Van Wart and Pfeffer’s opinions demonstrate there is enough evidence that interventions can affect managerial behaviour. This would depend on the sorting and filtering that goes on before the people rise to leadership positions as proclaims the Peter Principle (1996; 2011) rather that people rise to the most heights of their incompetence. The effect of leadership is of substantial importance in actual organizational situations (Pfeffer 1977). Such leadership or training effects can be seen in the attitudes and perceptions of the participants, learning, behaviour, and results (Pfeffer 1997; 134). Put in another way, such expectations are change in motivation, attitudes, or values or all three, the learning objectives of interest are affective outcomes (Schuler and Jackson 1996).

Socialisation is an initiation into the organisation culture and philosophy for both new and old members of the organisation on entry or move to a new job respectively. Schuler and Jackson (1996) continue to differentiate that training is about improving skills requirements for now and the very near future; and, development skills last for a very long term. Sourcing, therefore, the function of Drucker’s ([1973]; 2008) Management Development for this purpose is appropriate as of its dual tasks related phenomenon that affects each other directly (Drucker 2008). Peter Drucker explains: one task develops management to ensure its health, survival and growth of the enterprise. Manager Development is the other; its purpose being health, growth and achievement of the individual. Furthermore, the explained rationale for management development is based on future obscurity and appropriate decision making to select, develop, and test the future fore-runners who will have to take care of these decisions.

The expansion of the person’s capacity to be effective in leadership roles and processes is its goal (Hackman and Johnson 2009). Peter Drucker notes it is primarily self-appraisal but requires active leadership by the manager and of the organization in the process. In his

explanation it is clear that: (a) management development is not taking courses but appears to be the norm (remember Pollitt's skill module learning above?); (b) both management development and manager development are not promotion, planning, replacement planning, or finding potential - contradicts the OECD model discussed earlier and fliers of Vision 2012; and, (c) management development and manager development are not means to changing people's personalities but for performance basically.

Management development is both a function and activity of the organization with its prime question being: What sort of managers and knowledge professionals will this organization need tomorrow to achieve its objectives and to perform in different market, a different economy, a different technology, a different society (Drucker 2008) or in the case of the uncertainty and size (Mohr 1982)? It deals with the appropriate skills for future, and organizational structure and the design of managerial jobs and careers (expert/profession). Management development requires power and prestige due to its object to change the basic planning of the enterprise, the structure of its organization, the design of its managerial jobs and purging obsolete tasks and products. Management development in this form is *an innovator, a disorganizer, a critic* (pp. 255; emphasis original).

Reforms are not apolitical (Rhodes 1997; Cole and Parston 2006); as such the goals or objects must be the preserve of higher management with the power to approve or not as deemed necessary and their development is the partly and the first responsibility of the manager (Drucker 2008; 264). In Drucker's view: "management by objectives and self-control may properly be called a philosophy of management" [consisten with Hood's Perfect Administration's uniform objectives to officials (Younis and Davidson 1990); and, from this ideal point judgement is commonly placed on bureaucracy (Minogue 2001); as it rests on the concept of the job of management and on an analysis of the specific needs of the management group as well as of the obstacles it faces. It is based on human action, behaviour and motivation; it applies to every manager irrespective of level and function, and to any organization not withstanding its size; management philosophy, therefore, ensures performance by converting objective needs into personal goals; and this is genuine freedom (Drucker 2008, 267).

The Drucker's model concerns include the age structure of the management group. This is very pertinent to the Finnish Government Vision (MoF 2002; Pollitt and Bouckaert 2004) as it factors in the population structure as a result of the well know baby boom phase out all

across Europe. The Vision document has it that about 85% of the present top management and 55% of the management in central government are expected to retire by 2012. But generally, the work-age population in Finland has started to shrink effective 2010 (OECD 2010; 7). Demographic phenomenon might have been known for long that the future belongs to the youth: Both the Chinese Mandarin Model (Riggs 1994), the Ottoman and Republican Turkish Models (Heper 1994) and the Singaporean model (Jones 2002) target the youth or young generation for a total new manager and professional.

The Ottoman model may throw more light on the crafting and demographic developments of public managers for quality work and values of coherence, justice, faithfulness and loyalty. Heper (1994; 660) wrote of 1453 following the collapse of Constantinople: “initially young “Turks” were recruited, gradually Christian boys, specially levied and educated, constituted the backbone of the civil and military bureaucracies. From among the brightest among, a group is selected to be trained in the Palace School (*Enderun*), established by the Mehmet the Conqueror (1451-1481). ... There they received an intensive training lasting as long as 12 years. Eventually the chosen few were given responsible positions in the civil bureaucracy. Others were destined to serve in the military.” The top bureaucrat titled “Pasha” were four out of nine grades; they well paid and motivated; but the most complain of the pasha fell on the narrow perspectives of the political leader (Heper 1994). Similar anticipation disruptive fear of the American Congress led to the failure of the mandarin emulation (Riggs 1994). From Selznick, OECD, Pfeffer, Bower and Weinberg and Heper’s views it is deducible that managerial leaders must be well educated and possess broader views of society as a function of statecraft. But the sitting political cultures appear narrow in themselves and frustrate Broadview development.

Broadview development is crafting in this study view. Drucker (2008) and Mintzberg (2009) talk about crafting, science and art of managing as well. Crafting, however, remains elusive and distorted concept with time passage. Crafting is generic and belongs to no particular domain of human action. Craftsmanship may be non-illusory but distorted by Western civilization in Richard Sennett’s view (2008): It encompasses the desire and ability to do good work, that is, quality driven; the innate abilities on which the craftsman rests are unexceptional; they are shared in common by the large majority of humans and in a rough measure; its basic foundation are the ability/capability to localize or make a matter concrete, to question or reflect on its qualities, and to open up in other words expanding its sense.

Craftsmanship requires time [consistent with Hood's Perfect Administration] and will to attain quality work.

From archaic Greece through the Middle Age to Modernity, Sennett demonstrates the head and hand combined simultaneously to create and repair for human good. A Greek mythology hymnal offering praise to the god of skills, the master god of craftsmen Hephaestus used *demioergos* for craftsman: a compound word public - *demios* and productive – *ergon*. In archaic Greece and other societies it was taken for granted that skills are transferred from generation to generation with obedience being the prerequisite. Classical time change is evident in Aristotle's *Metaphysics* that "We consider that the architects in every profession are more estimable and know more and are wiser than the artisans, because they know the reasons of the things which are done." Aristotle's new word for craftsman was *cheirotechnon*, meaning simply hand-worker; thus theory based differentiation; and, theory preferable to handy craft for its longevity. Notwithstanding this change and down grade, public virtue of women weavers was still celebrated.

Craftsman as of males was engendered more by the development of classical science. This science, Sennett argued contrasted man and woman brain, muscle and so on; the gender distinction sowed the seed of a still-living plant: most domestic craft and craftsmen seem different in character than labour now outside the home. Interestingly he observes that we do not think of parenting as a craft as compared to plumbing or programming although becoming a responsible parent require a lot of learned skills. Sennett found in Plato's treatise about his worry of this demise: Plato had traced and searched for the skill and root word for "making" to be *poiein*; the source of the word poetry.

All craftsmanship is quality-driven work; Plato formulated this aim as the *arête*, the standard of excellence, implicit in any act: the aspiration for quality will drive a craftsman to improve, to get better rather than get by. In Plato's time he observed "craftsmen are all poets ... they are not called poets, they have other names." The *different names and different skills fragmented the people preventing them from understanding what they shared in common* was Plato's worry. The five centuries before his time the *unity in archaic times between skill and community had weakened* (emphasis added). This slip away meant that practical skills still sustained the city's life, but now lacked honouring and its community.

Sennett’s conviction is that good work moulds good citizenship; which is the basis for self-government; became distorted and perverted in the course of modern history [also public management after cameralism (Lynn 2005)]; inequality established by invidious comparism came to the fore appearing as more reliable truth about work - but this ‘truth’ undermines democratic participation; sharing the ability to work to teach us how to govern ourselves and to connect to other citizens on common grounds is today’s necessity. At least, Sennett noted further that the Enlightenment era was convinced that learning to do good would promote self-governance (Sennett 2008; 22-5).

Relatedly, but in different context, Lynn establishes at the late eighteenth century public management controversy begun as a result of the intellectual and political developments that idealised bureaucracies and law set as the basis for officials training; thus, undermining the successful Cameralism and its achiever Consultant Administrators who participated at the very highest level addressing general practical problems and issues of public management and administration (2005).

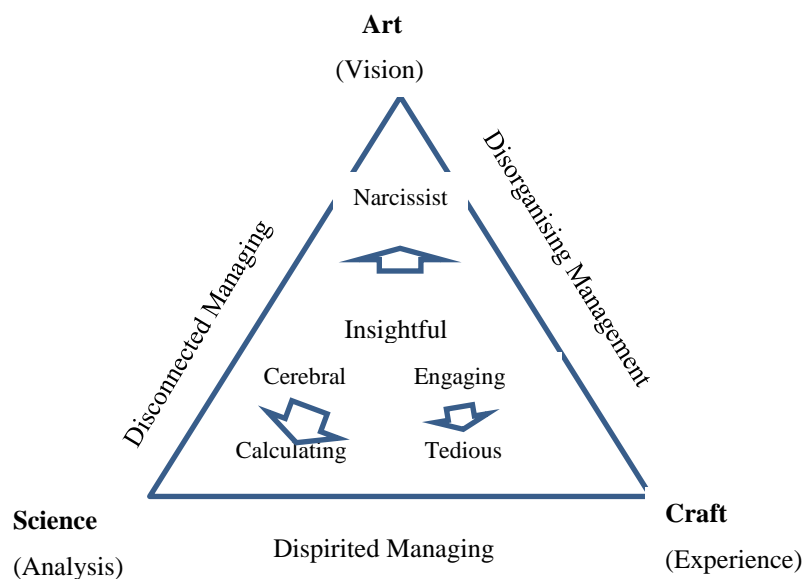

Figure 4: Styles of Managing in terms of Art Craft and Science adapted from Mintzberg (2009)

Mintzberg argues effective managing falls on art but rooted in craft; while art yields the ‘insights’ and ‘vision’ based on intuition craft deals with experiential learning. The practice of management is ‘soft’ and that explains its labels including experience, intuition, judgement and wisdom. Put together, a good deal of craft with the right touch of art alongside some use of science and you end up with a job that is above all a practice; in several styles and postures

seen in Figure 4 above adapted from Mintzberg (2009; 127). Mintzberg notes (with emphasis) that **effective managing requires the mix and blend of art, craft and science whether in the person of the manager alone, or in a management team that works together**; in other words management may not be a science but it does need some of the order of science, while being rooted in the practicality of craft with some of the zest of art.

With this brief on the nature and theory of crafting, management and managing ideas are about will-values, capability, remarrying the divorced head-hand, institutional building, politics-administration/management, expert/professional-manager/community relationships grounded in quality and the desire to do good to humankind through the processes of systematic practice and context. Practice in the fore going process is highly priced to talent in skill development (Colvin 2008; Sennett 2008; Mintzberg 2009). Colvin argues the best methods of development are constantly changing with higher expectations; and they are built around central principle; they are meant to stretch the individual beyond his or her current abilities via practice. He explains the model with MIT Professor Noel Tichy's three concentric circles from within: comfort zone, learning and panic zone. This framework could put the current manager in the comfort zone devoid of capability and practical skills, and value-will moral upliftment. It is especially so, when ethics are least discussed for transformational leadership (Bass and Riggio 2006; Shafritz and Russell 2003) and management but more of fashioned driven external and economic forces (Reichard/PUMA 2002; Taylor 2001; Pfeffer 1997), as found in transactional leadership style of rewards (Bass and Riggio 2006); let alone to vent outwards towards the learning and panic zones to strive for progress and quality.

In another linguistic way, Bass and Riggio (2006; 7-16) Full Range of Leadership Model could be rearranged along Colvin-Tichy three concentric circles from the inner towards the outer as follows: 1) the comfort zone as laissez-faire leaders – The laissez-faire avoids leading; and, by definition the most inactive and ineffective of leadership by avoiding responsibility altogether. 2) The learning zone as transactional leaders – Such managers would reward or punish the subordinate depending on performance results. Such leaders depend on contingent rewards or more negative or passive forms of management-by-exception but could be effective; and, 3) the panic zone equates transformational or charismatic leaders – Usually thought to be morally effective, leads to commitment and performance oriented while depending less on rewards. It also involves both directive and

participative processes. Basically, the theory establishes that it is a matter of degree to which every leader demonstrates the amount of any of the three different styles (Bass and Riggio 2006). Presumably, Mintzberg's disconnected, disorganised and dispirited managing, Colvin-Tichy's comfort, learning and unreachable panic zones and Bass & Riggio's Full Range Leadership Model explain away the Selznick's elusive craftsmanship or Sennett's distorted craftsmanship leaving a bereft manager of this era void in a comfort zone; while policy and implementation suffer. From this perspective, systematic models of managerial leadership education and practices enshrined with broad governmental and societal views are a necessity to move out from the void comfort zone.

4.0 The Finnish Senior Civil Service Vision 2012 Reform

“Implementation process’ as a strategic interaction among numerous special interests all pursuing their own goals which might or might not be compatible with the goals of the policy mandate” (Bardach 1980; 9) fails to be a joined up process (Pressman and Wildavsky 1984). These statements align with the woes of the manager as the nature of the managerial environment attests. Findings from the analysis due to lack of elements of implementation communication or managerial communication generally, will-value, capabilities, poor social world handling and other incompetency can account for this reality of the ‘hostile’ policy or reform environment – politicians, civil servants, the governed and other stakeholders.

4.1 Administrative reform characteristics Typical of Finnish and the Nordics

The Finnish Constitutional value requirements for the appointment of ministers are ‘honest’ and ‘competent’ (Section 60) and other general officials require skill, ability and proven civic merit (Section 126). On toolkit of the political manager, the Finnish political parties lack think tanks and even the entire public administration works not with the universities (OECD 2010). But the relationship between public administrators and their political masters is governed by values set of political loyalty, accountability and responsiveness (Bozeman 2007; 140); all is to enable service to the people and to themselves at least in theory.

Practically as noted already, the latest national overhaul indicates the on-going reforms strengthens status quo and citizens’ participation in government still remain weak (OECD 2010). A number of factors were enumerated by Brunssen and Olsen (1993) on Nordic region

– Finland, Sweden, Norway, Denmark and Iceland - style of reforms as follows: governments were observed to be stingy with money for administrative reforms; this provides illustration of the limitation of parliamentarian and ministerial hierarchy; reform agencies are politically weak and of low status, and often necessary resources for administrative policy were controlled by other state organizations, that are uncooperative (OECD 2009; 2010). Brunssen and Olsen advanced their argument to compare with the British Prime Minister's office as the coordinating and directing point of reforms from the highest level of political authority; while citing Mellbourn and Olsen's ideas to show that the Nordic countries failed to build any ambitious aim of a comprehensive administrative policy in the reform process. Pollitt and Bouckaert (2004) attest to this and found media apathy as well as political party ideology fails to blend and influence public management reforms in Finland in particular.

Nonetheless, the Nordic Governments are committed to consensus to avoid conflicts (Brussen and Olsen 1993; Pollitt and Bouckaert 2004; Christensen 2006). However, Christensen argues that on structure and instrumental aspects the Westminster Parliamentary system type promotes better policy implementation than the heterogeneous Nordic or continental European coalition governments and parliaments. Pollitt and colleague agree to the cooperativeness and further assert anti-state attitudes of the USA are rare; however, limited manifestations of protests over aspects of some changes have been observed in Nordic countries (Pollitt and Bouckaert 2004; Pollitt 2007). Such views appear suggestive of two things respectively: First, soft tools are availability such as negotiations, bargain and collaboration in the system. Yet, Peters (2006; 117) asserts, it is difficult to work across divisions even within the same ministry. Second, a one person demonstration should not be written off or taken for granted as it could be a representation of a large group considering the low-context nature of the Finnish Society (Finnish Literature Society 1997). This differentiation may confirm as well establish silo-slab phenomenon and the nature of its inertia generation and interactional forces to affect implementation.

Finland, described Pollitt and Bouckaert (2004), is a unitary state, decentralized and fairly fragmented; and as of six years later "fragmented stovepipes" as leaders would not cooperate and collaborate (OECD 2010; 20). Per this study, the 'elusive' collegial management tradition Tiihonen (2001) recalls in government has given way to the independence of the ministries; now well managed with hard tools to protect turfs (OECD 2009); a tenacity process (Bardach 1980) adopted following the dissolution of the traditional Nordic

Ministerial Boards that brings more power to the individual minister (Finnish Literature Society 1997; Pollitt and Bouckaert 2004). Furthermore, (Pollitt and Bouckaert 2004; OECD 2009/10) observation is that the relationship between the minister-civil servant to be separate and fairly politicized. The situation is exacerbated with the political secretaryship introduction resulting in the ‘separation of powers’ in the policy development and implementation process, as well as a wedge between government, public service and, of course, citizens (OECD 2010; 19).

Modernizer Finland, to use NPM reform parlance, “has not slavishly followed fashions but rather carefully selected and piloted those ideas considered suitable for Finnish needs” and usually by a fairly small group of elites (Pollitt and Bouckaert 2004; 239). Furthermore, both consultants and foreign academics have assisted with information gathering and advisory purposes leaving out actual implementation with the career civil servants. Implementation process in the Finnish system is gradual and deliberate. This is defined by piloting and extensive training to guarantee successful implementation, (Pollitt and Bouckaert 2004). Bryson and Crosby (2004) call this practice staged implementation, one of two types. Direct implementation, the other, deals with all changes into all relevant sites essentially simultaneously as applied to Vision 2012 policy under review. Very interesting observation of the reforms is that (Pollitt and Bouckaert 2004) the regularly conducted evaluations find no, program utilisation (Patton 2002). The analysis reveals that reforms are subordinated and public interest seems to be “served by a cosy and secretive policy cabal” (Minogue 2001; 221). Agreeing with the OECD and others, the core challenge then is for the government to seek new ways to work across levels of government, with key stakeholders and citizens (OECD 2010; 8; MoF 2002; Minogue 2001).

4.2 The HRM/manager need and performance management reform in government

The Drucker Management Development base of demography becomes apparent in the scarce OECD HRM/manager need and skills due to the baby boom demographic changes (OECD 2010; Pollitt and Bouckaert 2004). Tiihonen (2001) records, Personnel Administration have been made more flexible, competitive, active, decentralized and streamlined by the public management reforms in the 1990s: the negotiations and agreeing terms and conditions of employment; and transfers or postings became possible within the Finnish public

administration. The traditional merit system was restored having been politicized; and, its source is traced to The Finnish Constitution (1999/2007) Section 125. In the new policy for government officials' recruitment, qualification was of two kinds, namely, statutory and general. These were explained as statutory qualification being a higher academic degree, expertise, proven managerial ability and managerial experience at senior government level. On the other, mention was made of ethics, extensive experience, teamwork and communications, language proficiency and development potential. Leadership skills have since been and increasingly important a general qualification for senior civil servants (Tiihonen 2001).

The OECD recounts a Nordic and Finnish work tradition of workers preference of local government work as well as staying put in a locality, thereby, inhibiting mobility. Another feature is the Finnish public administration prefers highly specialized expertise rather than generalist management skills. Although expertise of such leaders are within only their fields they are without a good inter-organizational experience and skills of horizontality and whole-of-government view (OECD 2010; 24). Speaking of that raises alignments problems of mobility both inter and intra of the Finnish state system. Perhaps, this situation is due to the fact that it is left to chance as no institution found responsible for such coordination. What may be near to such a responsibility is the establishment of "strategic proposal 6 ...setting up a joint development unit for managers in central government" under the Ministry of Finance for the on-going study policy (MoF 2003; 32).

But elsewhere in the corporate world and perhaps few governments, deliberately mobility is done for learning, growth, broader perspectives and development (Schein 2004; Colvin 2008; Jones 2002); and even used to break boredom and for refreshment on the job (Sennett 2008); or burn outs as well as provide management with preview of a candidates potential (Schuler and Jackson 1996). The Singaporean Civil Service could be unique in its mobility system as it moves people across the three sectors of non-governmental/civil society organisation, business and public (Jones 2002; Yip and Wilson 2008). The processes are both vertical and horizontal, progressing from narrow to broad and, simple to challenging and difficult as well subordinate to superior. The inference so far could be that expert managers' governance without these rich experiential practices has brought the system this far of its silos; and, the Finnish system has no evidence at least from the paper review of systematic facility for its management and leadership development.

Similar to the Finnish reform understudy is the Northcote-Trevelyan reform. From hindsight the British Civil Service of the 1850s lacked merit and had a poor reputation with no unity of purpose; hence amid resistance the Northcote-Trevelyan reform of 1853 introduced merit based open competitive recruitment, promotion, recruiting into a unified civil service, and a hierarchical structural placement of classes and grades. A century later in the 1960s The Fulton committee revealed that the Civil Service still harboured the old ethos of rigidity and inefficiency due to lack of professionalism and skilled managers. Fulton recommendation included a Civil Service Department led by the Head of the Civil Service to run the Civil Service; the abolition of all Classes for a unified grading structure for all (Civil Service.Gov.Uk 2010). Unfortunately, it is inferable that recent British “next steps” reforms have, indeed, reversed by fragmenting this centralization and rationalization of departmental management (Polidano 2001: 57; Rhodes 1997); and perhaps being re-join up in the current so-called JUG process (Blair 2010; Rhodes 2008; Peters 2006; Pollitt 2003).

Similar occurrence in the United States led to the Pendleton Act in 1883 which introduced in trying to model the Chinese Mandarin system. Riggs (1994) describes the classical Chinese mandarin system to start the recruitment by academic not practical exams, closed not open, and leads to status not position based career system. In this manner young university graduates take up a generalist career whereby personal rather position rank is fulfilled. He further states the properties of a generalist mandarin as follows: first it is, powerful and second it can coordinate programs at macropolicy level. Mandarins’ self-identity and self-esteem is the bureaucratic framework. As such, it is easy to network around bureaucracy to establish their power position. Riggs views their telepathy come more from experience than academic qualifications to provide them with “genuine managerial competence and an ability to look at the overall needs of a government. They understand how diverse and often competing programs can be coordinated, and they can achieve administrative excellence without formal pre-entry in public administration training” (Riggs 1994; 112).

The Pendleton Act brought in practical examinations, open recruitments, tenure careers; led into a new kind of functionally specialised careerism with orientations to specific jobs, program areas, policies and end up in professions as an outcome. Examining professional knowledge and capabilities as well as openly recruiting experience professionals into the public service together brought about the US professionalization of its public service career. The Hoover Commission in 1955 attempted to establish a cadre of generalist as well as the rotation system was resisted by Congress. A compromised senior executive service (SES)

was established by the Civil Service Reform Act of 1987. In place of the youth it recruits outstanding professionals or existing functionaries who could not sever their existing networks and standards for mandarin purposes. No accounts of mandarin properties are visible of the SES.

Following from the above chronicles, Governments therefore, need to step up their personnel management to be competitive with the other sectors in future labour markets developments. The NPM/HRM reforms ushered in higher currency to performance management (Reichard/PUMA 2002; Taylor 2001); via flexibility and responsiveness (Brown 2008). Reichards' practical logic of performance management to HRM is formulating clear and challenging targets, translating targets into performance indicators, measuring the results, taking necessary corrective actions and rewarding the actors; while setting the prerequisite necessary for the change to a performance culture of civil service reforms. Most reform proposals deal in one or another form of strengthening performance or of introducing new performance measures/instruments into public sector organisations. From process view, "performance means the transformation of inputs into outputs for achieving certain outcomes. With regard to its content, performance informs about the relation between minimal and effective cost ("economy"), between effective cost and realised output ("efficiency") and between output and achieved outcome ("effectiveness")" (Reichard/PUMA 2002; 1).

The document continues that public sector reformers relate three different objectives with performance management citing OECD (1997a, 26f): improving management and service delivery; strengthening accountability and control; and, realizing savings and financial cutback. Purposively, performance-orientation agenda into HRM is to promote commitment for performance within the public workforce; so as to strive for better performance in terms of their activities reflecting the so-called 3Es; as subordinates achieve the performance targets set by their superiors [but note this study policy is more of lateral than vertical, that is, superior-to-superior target]. Such a performance-orientation of the workforce can be realized by appropriate concepts and tools of HRM:

- Effective recruitment and selection procedures (attracting and selecting "high performers");
- Education and training concepts and instruments, including management development and
- Leadership training for building necessary skills and attitudes of performance management (Reichard, 2002);
- Attractive motivation and incentive systems which motivate for performance;

- Adequate job placement which allows the utilisation of existing potentials and capacities of personnel (including regular rotation etc.);
- Stimulating leadership behaviour of managers (including adequate recognition of the performance shown by subordinates);
- Frequent performance-based reviewing and appraisal of task-fulfillment (including feedback to subordinates);
- Rewarding good performance with material and immaterial rewards (including performance related pay);

Furthermore, and similar to this study philosophy of aligning implementation communication to the individual so does performance management viewed as a deficit of current public management reforms in that measures to strengthen performance at the corporate or unit level are not adequately linked with performance measures at the individual level of HRM. The main challenge of matching the two levels is to safeguard the commitment of all members of an organisation to achieve performance objectives. The performance of the organisation or of the respective unit should become a relevant objective of every individual member of it. And the organisational performance must be linked with challenging incentives which are attractive to all members of the organisation” (ibid; 5; also see Drucker philosophy of management).

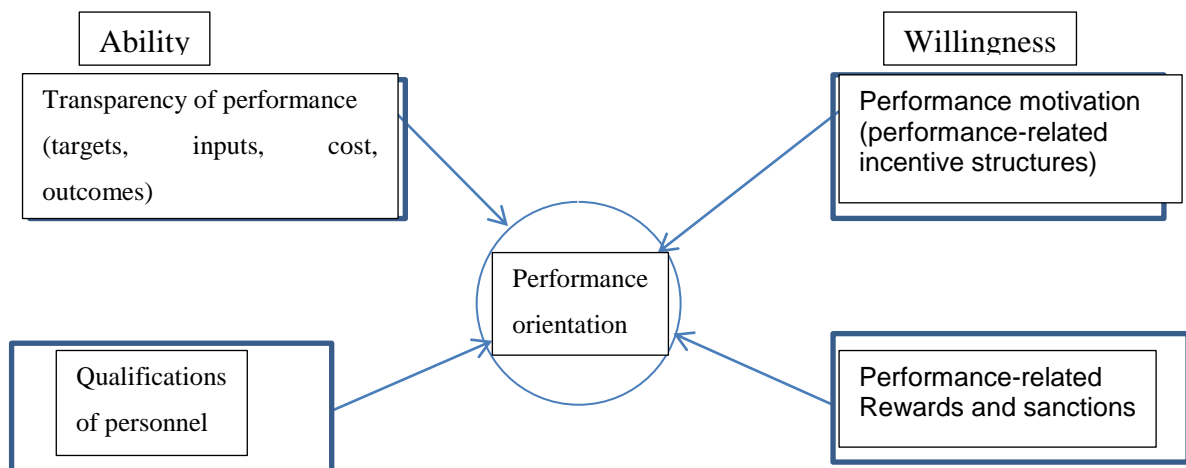

Figure 5: Aspects of performance orientation for public servants adapted from Reichard/PUMA (2002; 4)

The above Figure 5 elaborates performance orientation fell on ability/capability of an individual employee and on his/her willingness to demonstrate performance based on both material and immaterial motivation according to the authors. It explains motivational performance orientation of employees via two perspectives: 1) motivation for performance

management and, 2) motivation by performance management. While the first case it is the question which incentives are relevant to strive for high performance. In the intrinsic other, it is achieving set targets with a high achievement motivation. Practically observed is resistance of bureaucrats against concepts and instruments of performance management practices (Gold 2003; Reichard/PUMA 2002).

The incentive systems play a major role to motivate employees for performance orientation. The empirical evidence is that public employees prefer a pluralist incentive system (“cafeteria-system”) which offers a broad choice of extrinsic and intrinsic incentives and rewards. Importantly, Reichard/PUMA found most civil service systems fail to identify this requirement, as they remain strongly locked on material incentives (example: bonuses and social benefits). A further distinction brought out two different purposes of incentives: motivation for a job; and, motivation on job performance. Thus consistent and repeatedly the value-will and capability of the actor matters and remain the core of this study as exhibited and must be aimed at both for and on the job performance.

Reichard/PUMA major elements of a performance-related HRM concept connecting with an overall performance management system of a public sector organisation from reform programs are of the following elements:

- a clear mission statement and corporate identity of the respective organisation, based on participation of staff;
- a pluralistic incentive system;
- performance-based training and development measures;
- a participative process of goal setting, program formulation, budgeting and evaluation of outputs/outcomes;
- translation of performance indicators into individual performance agreements with a clear focus on individual accountability;
- performance-related leadership behaviour (feedback, recognition of work);
- measurement of the individual results of employees;
- performance related job appraisal and rewarding of good performance (performance-related-pay).

The Ministry of Finance is in charge and the lead agency of the Finnish Government Administrative reforms (Pollitt and Bouckaert 2004; Teemes 2004). Key parts of the Finnish Senior Civil Servants Development program have been laced appropriately throughout the above discussion. Now, comprehensively, the strategy is of a six-point proposal: a fixed

eight-year term on the top management particular job; with personal renewable contracts; based on common central model; develop mobility of managers; enhancement of joint development services and assessment based on common framework; and a coordinating unit for the pooling system. In all, the smartly set the envisioned model with “will to lead and develop” (MoF 2003; 16); as the very core and backed by values shown in Figure 6 below. What is clear and important is the reformers’ intent to protect and keep the integrity of the public service and the nation based on ethical and professional values as the development of the “professional” manager is set on. It is this model that is being investigated for its potency and how its Implementation Communication (although non-existent) has been pursued so far (see chapter V for details).

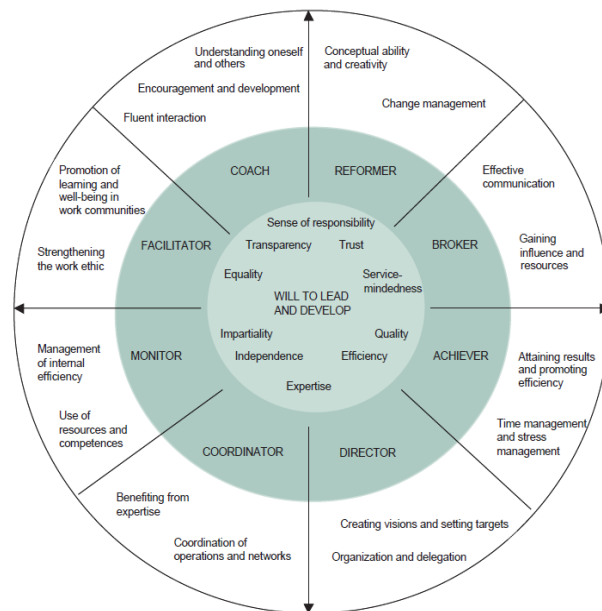

Figure 6: Basic Values and principle of management in central government, basic roles of top management and the related key competence requirements. Adapted from Ministry of Finance (2003; 16)

Agreeably, (Bass and Riggio 2006; Shafritz and Russell 2003; Bozeman 2007) ethical value based management and leadership is necessary for any country’s integrity. Today, it is even more an insurmountable task, with the quest of businesses activeness and bonus culture, corporate entities flirting with and wishing to override and take control of governments (Pfeffer and Salancik 2004; Pfeffer 1979; Galbraith 2004; Morgan 2006; Fuchs 2007; Stiglitz 2009; Hakkarainen 2009). For instance, Finland has since 2005 lost the top and enviable position on Transparency International ranking which she had kept consistently for some time

(Transparency International website 2000-2011). Finnish corporate business world has become suspicious of corruption (OECD 2010); the 2007 armament procurement deal, for example, was “good and transparent” testifies the former Croatian President, reports (*Helsinki Sanomat* 2011; also *The Wall Street Journal* 2011) is remarkable.

This study document is purely a civil servant mandarin invention with both Finnish/local and European/international touch (MoF 2003; 8-9). An act, Pollitt and Buckaert (2004), view to be consistent with the Nordic region public management reforms; although with low status (Brunssen and Olsen 1993). This managerial policy invention (Loveless and Bozeman 1983), claiming to be Finnish Government policy instrument leaves out its core contextual players as the Vision document reveals. They forgot the socio-political role of State; for example, as responsible for setting economic agenda, establishing the legal context, and as an employer (Bratton 2003), the private and third sectors and, of course, the governed. Innovation, however, is a process too, that goes with the public manager (Loveless and Bozeman 1983). Since no policy instrument is perfect or complete (Pollitt and Bouckaert 2004; Lynn 2003); it is these processes and contents that this study is following for their innovative evidences as suggested as continuous designing and problem identification matter in reforms and the policy process.

5.0 Desirable Results of the model

The cyclic Management Development reform process with its policy formulation and design, implementation, outcomes and evaluation utilisation from this analysis demonstrates discrete, distorted, and erratic episodes. It may sometimes even be contradictory to the very efficiency and effectiveness intended. Perhaps, as a result of manager comfort zone housing triggered off easily by economics making the reform more ideological rather than tested theories to follow Minogue’s thinking. Rhodes (2006; 433), for example, pointed out that generally in the reform and policy environment, the costive process of cooperation is “time consuming, objectives can be blurred, and outcomes can be indefinite”. Implementation researchers mostly settle on the output/implementer behaviour differentiated from outcomes/impacts (Winter 2006; Hill and Hupe 2002; Vedung 2002); and based on objectives or a problem (Winter 2006). In this case, implementation is viewed as a multiorganisational (Hall and O’Toole 2000) and a joint activity (Pressman and Wildavsky 1984) by senior civil servants and their political

bosses as well as other affiliated institutions or network of implementers (Bardach 1980) and individual actors to determine the outputs processes.

In this post-NPM JUG reform state a hybrid government manager is what should be in the making. That means not necessarily emulating the 'failed' private sector economic and profit driven manager as have been the norm but making innovation of it. Furthermore, by encapsulating the feasible reversible process of excesses of the Weberian bureaucratisation and incorporating some NPM/HRM features (examples, performance management and appraisals) and going beyond all that to develop the hybrid brand manager, imbued with will-value and practical capabilities; for creating value, the profit of government institutions, on societal needs (Moore 1995).

Productivity management in the US Government identifies factors such as increased competition between the public and private for declining resources; increased external foreign competitors; declining confidence in management processes and human resources; and lessening credibility of public organisational structures, designs and strategies in time of greater complexity and change (Shafritz, Hyde and Rosenbloom 1986). However, the Government document under review is competency based will-value imbued development (MoF 2003) ignoring structure and the policy environment from the paper analysis. Again, one of the pillars of Finnish success was niched on its Productivity Management of which the OECD (2009; 2010) is critical as it deals more with staff replacement cuts or numbers rather than the necessary required capabilities and skills.

John Gold observes that performance management systems are often based on a competency framework; [and aligned to the organisational strategy (Yukl 2010; Mintzberg 2009)]; and argues that appraisal functions as an information-processing system, providing vital data for rational, objective and efficient decision-making related to improving performance, identifying training needs, managing careers and setting levels of reward; but appraisals introduced from the privates sector culture are poorly managed in the government sector (Gold 2003). Taylor argues it is rooted to the New Rights' NPM/HRM agenda to change management practices such as having direct impact on the individual and the organisational performance such as selection, employee development, appraisal and managing pay. However, the thriving basic conditions for success, he discussed, are impartial civil service where rules and procedures are consistently followed to provide the public manager the

necessary discretion but the manager him/herself must abide by this uniform rules first and foremost before being authorised to construct their own rules; thus “they must operate in integrated centralised departments before being authorized to go it alone in autonomous agencies” (Schick 1998 in Taylor 2001; 182).

5.1 The Job Bank/Pooling System/Administrative Class

The Finnish Government Vision 2012 mentions the creation and maintenance of “job bank” or pooling system (MoF 2003; 32) synonymous to Caiden’s administrative class discussed above. Schuler and Jackson explain the processes involve in pooling: Recruitment is the set of activities used to obtain a pool of qualified job applicants; it is a reciprocity of needs between the candidate (personality, interests and preferences) and the job (skills, knowledge and abilities); with the determinants being both the long and short term organisational needs; linked to the job market at large (internal and external); developing effective recruiting materials; having a systematic and integrated program of recruitment in line with other human resource (HR) activities with the cooperation of line managers and employees; obtaining a pool of qualified job applicants; documenting the number and quality of job applicants produced by the various sources and methods of recruiting (skills inventory); following up on applicants whether hired or not, in order to evaluate the effectiveness of the recruitment effort; the availability of alternative work schedules or other forms of job accommodation, and Management Development programs can raise the pooling potential; above all, the recruitment objective needs clarification always (Schuler and Jackson 1996).

The study document goal is seeking centralisation with common culture (MoF 2003); perhaps, due to the inability of the formal to mix and blend with the informal (OECD 2010). Taylor argues in the developed countries informality influences are weakened by the welfare system, prevalent of nuclear family system. A further factor is that of communication developments which is found to encourage atomisation of society yet an ingredient for the success of NPM/HRM implementation (Taylor 2001). All these add up to the individuation, differentiation, context avoidance of power relations, and the nonalignment to strategy. Taylor concludes that reform should be contingency and built by the public service ethic thus seeking impartiality selection, promotion and appraisal via a centralised approach consistent with the Finnish Government’s implementation work at achieving its contracting, skilful and versatile pool of government managers by its vision stated as: “*Professional management*

guarantees the productivity, well-being and constant renewal of government operating units. Systematic development of management ensures the availability of future leaders and their commitment to a common management culture” (MoF 2003; 14; emphasis original).

5.2 Conclusion

Concepts are defined related to management development and implementation. For further grounding, theories and models of reforms, history/institution and practices explored to understand the individual and organisational behaviours in the governance process. Findings included: willingness, capability, games playing, powerful ubiquitous motivational roots and social pressures that can make or break the organisation/institution and its structures. Poor management particularly of the informal social pressure leads to silo formation. Finnish Public Administration happens to be described as a silo system, a modern feature. It is also thought to have been fermented with NPM dominant economic model reform that had enhanced horizontality problem. With silo problems in sight, culture change reform and the public manager environment were explored for capable ethical manager development. For capability and understanding purposes the literature in use is accessed for both the manager Needs Assessment is made and manager job defined; having found the current manager’s comfort zone is in the silo as a result of incompetence and personal iniquities. Perhaps, poor need assessments, job definition and its enrichments, and implementation might have contributed to the elusive crafting perspective and institutional leader transformation.

In all, it was found throughout the twentieth and nineteenth centuries government manager development has continued to be elusive; hither to, a reality: Several countries have tried to adopt and adapt the successes of coordination and leading classical Chinese Mandarin model that result into different models or failures. Perhaps, the most important and shared by most countries is the birth of Public Administration Professionalism and its insular culture as well as the Senior Executive Services – SES. The NPM reintroduction of public manager development advocates multi-skilled and pragmatic public manager. But conflictingly, promotes fragmentation and horizontality; thus a silo viewed manager. However, the post NPM governance or JUC counters the problem by coordinating all stakeholders’ interests for policy and implementation process; thus developing a broad viewed manager. In line, Vision 2012 envisions a smart government manager with broad government view within a central common culture rather than professionalism and insular culture.

This process requires crafting: management development with Broadview and multiskilling; taking responsibility and sharing responsibility in order to build long lasting sustainable trust both vertically and horizontally with the purpose of building and delivering public interests and values; as well as understanding their instrumental and intrinsic natures. But the challenges and barriers are numerous to include both the individual and organisational. Critically noted are the narrow view of politician and the unsupportive nature of the political culture of reforms particularly of management development; the expert's resistance and insular culture; the manager/administrative class incompetence. The apex mix is found in their comfort zones with weak links to the governed.

In this particular context, it remains to be seen how some of these obtrusive elements and that which is not found in this sectional review are affecting this policy and its implementation processes. The study challenge is then looking for the emerging Implementation Communication conduit properties for the manager development processes and the alignments to Government strategy for the last decade (detailed discussed in chapter V). This is so because the formulation and design of management development is thought to be critical and important than the implementation itself. In the next pages these could be revealed but first the present structure of Finnish Government.

IV Structure of Finnish Public Administration

1.0 A Historical Brief of the Structure

The Finnish Government Council of the Grand Duchy of Finland under the Tsar Alexander I of Russia ruled Finland having been ceded from the Swedish in 1808. Created in October 1809, the Government Council was the highest governing body of the Finnish Grand Duchy. In 1816 the Council was renamed the Senate, which in 1918, following Finnish independence, became the Council of State. Its two sections finance and justice later became the basis of independent Finland's cabinet and supreme courts respectively. At the same time, Government departments became ministries. The economic department became today's Ministry of Finance. Based on the Porvoo Diet of 1809, the Tsar to govern Finland in accordance with its existing laws and upheld the existing rights of ownership, and administrative practices. This was to have a decisive impact on the subsequent development of the Finnish state and society (Heikkinen and Tiihonen 2008; Koivurinta 2006).

A Senior Advisor, Hannu Koivurinta of the Public Management Development Department of the Ministry of Finance categorises the developmental stages of the Finnish Administrative system into the following:

- The “night-watchman state” period, 1809-1855, when administration was first created and managed as a function of the Senate.
- The 1856-1917 was the period during which the constitutionally governed State was created. During these years, the basis of the Finnish administrative structure was created.
- The 1918-1966 period, the early years of independence, when the foundation of the socialised, industrialised State was created. Social activity was centralised and State-managed, but the lack of resources and the presence of an external threat prevented the development of a genuine welfare State;
- The 1966-1987 period when the welfare State was constructed. During this time the administrative system grew many times over, while social conditions and the well-being of the people advanced auspiciously. In the 1980s the volume of public expenditure grew at a rate of almost 4 per cent per annum and the number of public sector employees at about 2.5 per cent per annum.
- The welfare State's adjustment phase, beginning in 1987, which will be remembered for the drastic measures used to cope with the welfare-state crisis that threatened the administrative system (Koivurinta 2006; 3-16).

2.0 The Overview of State and Government Structures

Finland is a constitutional republic and the highest organs of government are Presidency or Executive, Parliament, the Government and the Judiciary. The powers of State in Finland are vested in the people who nationally elect the President; and are represented by their Parliamentarians in Parliament; appointed Prime Minister and Government; as well as an independent Judicial System that ensures all are equal before the law. The Chancellor of Justice operates in conjunction with the Government, and, along with the Parliamentary Ombudsman, s/he is the supreme guardian of the law in Finland.

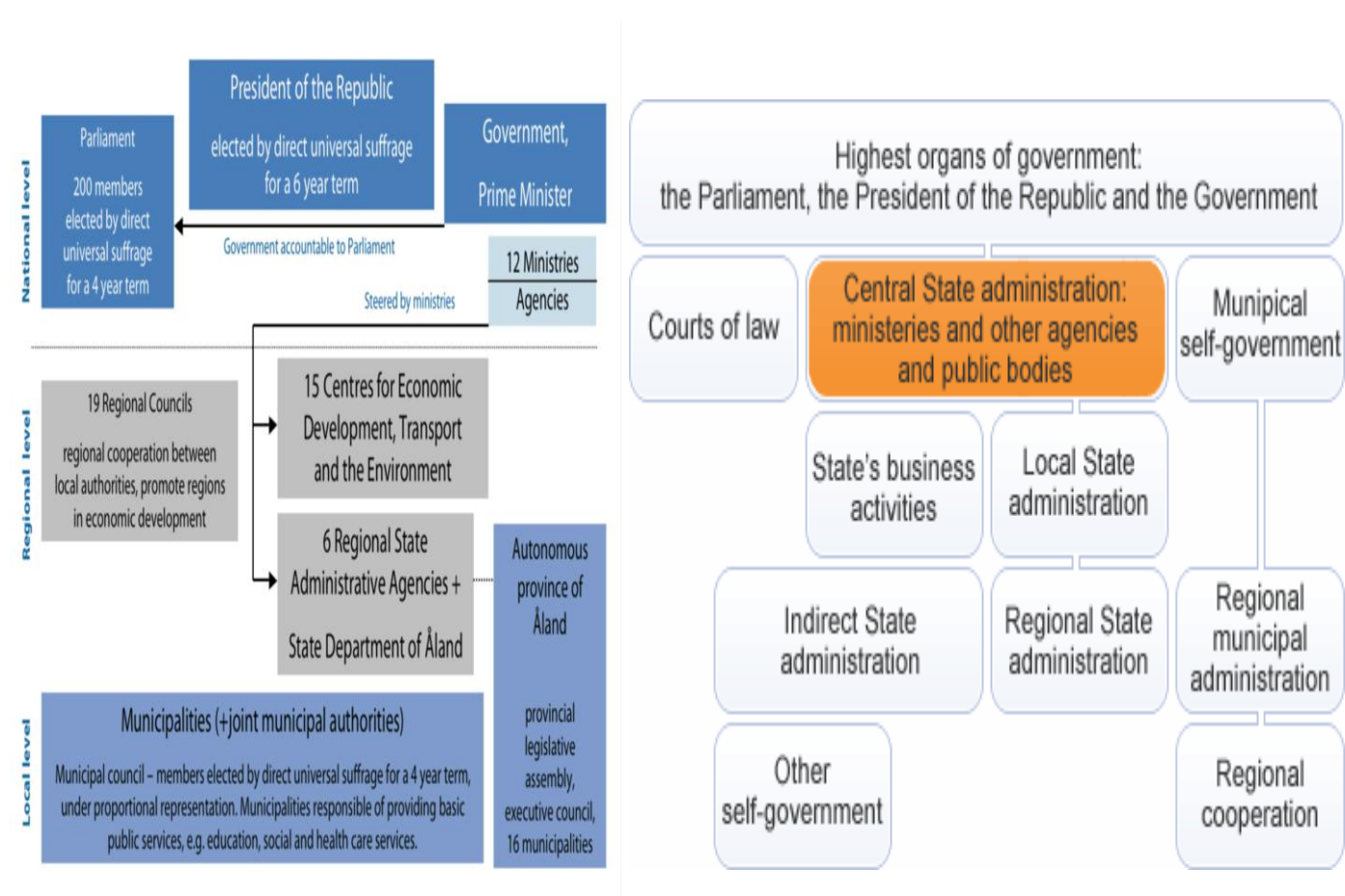

Figure 7: Organisational Charts of Finnish Public Administration Adapted from the OECD (2009; to the left) & Suomi.fi (2011; to the right)

These diagrams below show the position of State Administration in the structural diagrammatic form. The 2 charts of Figure 7 reveal an interesting phenomenon, that is, while the Finnish (Suomi.fi/Treasury) invention puts nobody in charge but all the four institutions at par horizontally [perhaps due to the Nordic culture of nobody to be seen higher

and outstanding (OECD 2010), and equality value (Finnish Literature Society 1997)] that of the non-Finnish (OECD 2009) places the Presidency in charge; indeed, a wishful thinking. This seems far from the reality and the Finnish Constitutional provision. Also, no ministry showed how it connects to the Prime Minister's office or the President's. And, therefore, not surprising hierarchical accountability runs into troubles, with poor monitoring but self-reporting dominance (OECD 2010).

Finland runs a three-tier structure – shown in pictures above: Central government is the entity covering: Government (cabinet & ministries). State administration in its highest form covers central, regional and local State administration. There is also indirect State administration which supports and complements the official duties of the country's public administration. Indirect organisations have no authority of their own, but carry out public tasks or execute public functions under the supervision of the Government and ministries.

Central government agencies and bodies are the National Board of Taxes and KELA (the Social Insurance Institution of Finland); most central government agencies and bodies also have regional and local offices. Regional and local State administration refers to authorities that operate solely on a regional or local basis. For smooth governance, Government must enjoy the trust of Parliament; with the President of the Republic and other institutions as well as the people. However, following the Constitutional reforms of 2000, and later 2007 the role of the Parliamentary-Government has become stronger in both national administration and EU matters at the expense of the Presidency.

2.1 The Parliament

In Finland is a unicameral Parliament; established since 1908's autonomous Grand Duchy. It is led by a Speaker supported by two deputies for an annual tenure. Finland declared her independence on 6 December 1917 and in the winter of 1918 endured a tragic civil war, for which Monarchists and Republicans struggled over the country's form of government eventually ending up with republicanism; and, extensive powers reserved for the President; although, the sovereign power in Finland has belonged to the people as noted above. Finnish Parliament is a 200-member unicameral legislative body. It is elected for a term of office lasting four years by direct, proportional and secret ballot. Parliament's legislative work takes place in committees, comprising the Grand Committee and 14 other committees representing

various fields. In Finland, the Grand Committee functions as the committee responsible for EU matters. On the basis of section 2 of the Constitution, Parliament exercises supreme decision-making authority in the nation. Parliament passes legislation, decides on the State budget and supervises the activities of the Government and the agencies, which operate under it.

Parliament approves international treaties and participates in the national preparation of matters, which are decided by the European Union. The Parliamentary Ombudsman, Parliamentary State Auditors and the State Audit Office work in connection with Parliament, as does the Nordic Council, which is the forum for inter-Nordic Parliamentary co-operation. The Bank of Finland, the Social Insurance Institution of Finland (KELA), and the Finnish Broadcasting Company (YLE) are under Parliament's direct supervision.

2.2 The Presidency

The President of the Republic under the Finnish Constitution, supreme executive authority is vested in the President of the Republic, while the general government of the country is the responsibility of the Government (Council of State) consisting of the Prime Minister and ministers. The President of the Republic is elected for a period of six years of maximum of two consecutive terms of office by direct vote of the universal adult suffrage. The vote is in two stages, if necessary should a winner fail to emerge. The President exercises supreme executive power in conjunction with the Government. The President has traditionally enjoyed extensive powers have eroded and revoked with Constitutional amendments. The President enjoys extensive powers of appointments: S/he ceremonially appoints the Prime Minister elected by Parliament and the Ministers proposed by the Prime Minister; also, appoints the highest state officials. The President has the right to decide, in conjunction with the Prime Minister, on the holding of extraordinary Parliamentary elections. The President also conducts Finnish foreign policy together with the Government. Despite all these presidential roles the government is largely a Parliamentary-Government with barely all ministers coming from the Parliament. The highest civil servant is Major-Domo who reports not directly to the president but to the Secretary-General of the Presidency, a political non-elected officer.

2.3 The Government

The newly power imbued Government exercises supreme executive power with the constitutionally weakened President. The Government also drafts bills and manages the State budget. The role of the Government has expanded dramatically since the Constitution Act entered into force in 1919, and since the 1980s, the exercise of supreme executive authority has in practice shifted more towards the Council of State. The Government comprises the Prime Minister and the ministers as political heads of the ministries. The Prime Minister is the political leader of the Government and is responsible for reconciling the differing views on Government policy held by the various groups represented in the Government. The Prime Minister is also responsible for coordinating the work of the Government with that of Parliament. The new Finnish Constitution which came into force on March 1st, 2000 has strengthened the position of the Prime Minister. The Prime Minister directs the activities of the Government and oversees the preparation and consideration of matters that come within the mandate of the Government. The Prime Minister chairs the plenary sessions of the Government and statutory Cabinet Committees. Finland is a Parliamentary-Government System appropriating all powers to its self.

The Ministers head their ministries and the related sectors. Typical of the system a single ministry may, however, have more than one Minister, in which case the administrative sectors of the ministry are shared or fragmented between the Ministers of different political parties. The individual minister's power has also increase following the abolition of the traditional ministerial boards (Finish Literature Society 1997). Currently, the Government consists of 12 ministries including the Prime Minister's Office designated as such (See Appendix 5). Each ministry is responsible for the preparation of matters within its field of competence and for the proper functioning of administration. But turfs are found, to the opposite, well protected and managed vertically backed by the law (OECD 2009; 2010).

Below the permanent secretaries and permanent under-secretaries are the director-general ranks. There are 20 Ministers (and their state secretaries), 11 permanent secretaries, 10 under-secretaries and ... director-generals. From the director-general rank up to the Minister form the strategic apex or top management of a ministry where the policy processes dealt with and managed in conjunction with other relevant institutions. In total the national government

managers range between 200 (Pollitt and Bouckaert 2004) and 140 including the local levels (Ministry of Finance 2010).

However, four outstanding issues are unclear in this structural analysis: First, what is meant by the Major-Domo and how does it relate to the other civil service rankings such as permanent secretaries and under-secretaries?; second, why the prime minister's office lacks a permanent secretary and third, why both senior most civil servants in the president and prime minister offices report directly to the President and the Prime Minister respectively but to non-elected political appointees different from their counterparts in other ministries? With this tall hierarchical arrangements and fragmentations how is coordination achieved with more than a minister and undersecretary but one permanent secretary? Efficiency is obviously tampered with as structural inconsistency, capacity and power implications are to contend with. Below is the Ministry of Finance structure shown as an example of how tall the hierarchies and broad functional a ministry could be.

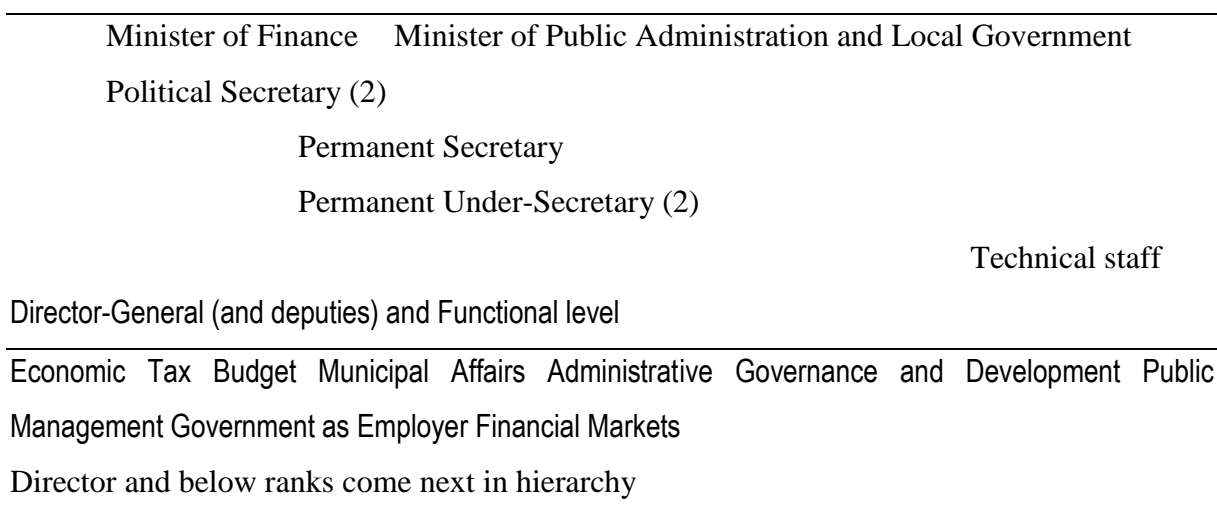

Figure 8: A typical Ministerial structure citing the Ministry of Finance 2012 Model

The OECD (2009) recalls the number of ministries since the 1950's were 11 and increased to 13 by 1987; but as a result of a merger of Labour, Trade and Industry reduced it to 12 and giving birth to Employment and Economy Ministry. Although these ministerial combinations and compression labelled the Finnish Phenomenon by the OECD have held the numbers almost constant and small, they fail to generate that compact effects as the previous chapter demonstrated. The Finnish phenomenon has its pros and cons: the OECD (2009) reveals cracks along political crevices contrary to the synergies, better coordination, and good

governance intended to generate. There is a weak prime minister and government at the centre, strong individual ministers, ‘separation of powers’ between politics and bureaucracy, exacerbated by the introduction of political secretaryship (roles undefined), and amongst the civil servants due to the culture of experts not seen to be led (OECD 2010) at the, strategic apex (Mintzberg 1997), thereby creating ministerial decentralisation (Mohr 1982).

Prior observations included the early 1980’s structural reforms of ‘Towards one-tier central administration’ caved in to the 1990’s steering and performance management reforms (OECD 2009). This is to suggest that the quest for a central administration with common culture (MoF 2003), is not new after all as noted above as a constitutional requirement; but the Vision 2012 failed to re-invoke or co-opt it or be informed by that. The Finnish ministerial hierarchy as observed from the sampled model are tall having escaped the structural reforms, without delayering (Tiihonen 2001). Contrary to Section 119 of the Finnish Constitution (2007) the Central administration consists of the ministries and relatively independent agencies; called silos or stovepipes (OECD 2009/10).

2.4 The Regional and Local Government

In Finland, like in the other Nordic countries, the most important task of public administration is to take care of the main part of welfare services for citizens, such as education, health care and social affairs. State administration has an average total number of 125 000 employees, 5 000 of whom are employed in the ministries, 24 000 in other central administration agencies and institutions, and 55 000 in regional and local State administration (Suomi.fi/State Treasury 2010).

State administration participates in regional and local administration in co-operation with regional and local officials. An integral part of public administration in Finland rests on the relations between the State and the municipalities, which largely function autonomously. Due to the increased tasks of the welfare State, public administration began to expand rapidly from the 1960s onwards. Until the 1980s, Finnish State administration followed a model in which public tasks were the joint responsibility of the ministries and central agencies. In regional administration, public tasks were the responsibility of Provincial State Offices, with

the regional authorities representing various fields. In the early 1990s, the structures of State administration underwent a reform, partly due to the difficult economic recession.

The system of central agencies is abolished; the number of Provincial State Offices reduced (see OECD chart in Figure 8 for statistics) and several agencies were replaced by State companies and State business enterprises shown in picture below as Figure 9. The new reforms entailed increased operational and economic independence for the municipalities. Also aimed at is strengthening the municipal and regional levels of administration – the PARAS and ALKU reforms. These reforms take effect January 2010. The objective of the PARAS reform is to ensure a sound structural and financial basis for municipal services in order to secure the organisation and provision of these services into the future. In this reform, municipalities are encouraged to either merge or increase horizontal co-operation via joint service agreements in order to improve efficiencies in service delivery.

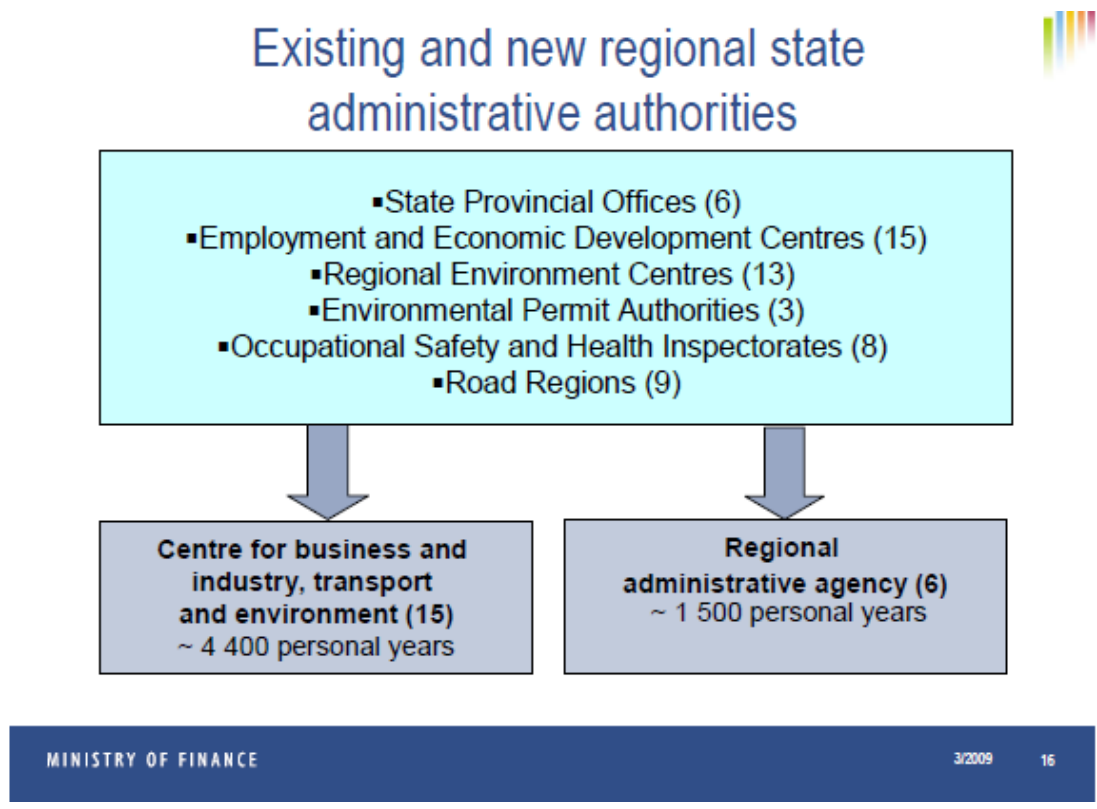

Figure 9: New Regional and Local Government reforms adapted for the Ministry of Finance (2010)

The ALKU project rationalised the system of regional state administration by clarifying and reorganising the roles, duties, steering and regional division of all regional administrative authorities. It increased the powers of the 19 Regional Councils to bring together and co-

ordinate regional development activities, and to give the Councils increased responsibility for strategic tasks. Existing regional state authorities (of which there were 54) were merged into two new regional state administrative authorities: the Regional Administrative Agency (AVI, 6 agencies shown in picture) and the Centre for Business and Industry, Transport and the Environment (ELY, 15 centres also in picture). As a result of the reforms of State administration, the number of staff under the State budget has decreased from 215 000 in 1988 to the current figure of 125 000. In the early 1990s, Finland had a system of central agencies, whereby about twenty central agencies shared responsibility for central administration with the ministries. As the central agencies were abolished, the collegiate bodies, which led them, were replaced by boards for the agencies and public bodies that have acted independently since.

2.5 Conclusion

It is possible to conclude by the OECD's (2010) observation that the Finnish Public Administration is rigid and sluggish as such non-responsive to the people and businesses. Some changes have occurred as a result of the reforms but more could have been done if the reformers took into account the dynamics or processes involved between collegiality and independence. The hierarchies are too tall with multiply tiers horizontally. The politico-administration interface is distorted by ranks, functions and formal structural authority perhaps making the reforms mechanistic rather than integrative. For example, the analysis further failed to find the overall in-charge of the country depicted in the OECD chart in Figure 7 above.

Taking it from the last chapter the national values, interests, and all the on-going structuring appear to work towards the individual and/or party/bureau interests resulting in coherence and coordination difficulties, thus if attempted at all. These stand against the purported Vision 2012 centralisation and common culture; and the OECD (2010) collective commitment. These legitimise questioning Vision 2012 policy and implementation started almost a decade ago. As clearly and outstandingly no one institutional leadership and institution, structurally, have a total view and management influence of the country. Thus subverts a necessary state responsibility and structural negligence of national institutional leadership.

V The Reform Case

1.0 Introduction

This study is looking at how the Ministry of Finance for that matter Finnish Government has communicated and coordinated its management vision of 2012's implementation to this day. It did precisely identify its role with the paper work except of the establishment of a joint development unit for coordination the program as it is intuited as the sixth strategy. The rest were thrown out there to the ministries and their departments and agencies, as responsible for their own implementation (MoF 2003); a practice emphasised in building sustainable quality reforms in Finnish style (Turunen, Karjalainen and Metsäpelto 2006). On that base, the Ministry of Finance acts as consultants pursuing the role of policy document preparation, the most favourite of consultants while avoiding the dreadful implementation (Brunssen and Olson 1993; Gummesson 2000; Cockman et al. 1999). Further reasoning could also fall on the expert-silo perspective of the system per this analysis. But first, who is Ministry of Finance the home and owner of the reform?

1.1 The Finnish Phenomenon and Home of the Reforms

To have implementation well done, Cockman, Evans and Reynolds (1999) think that successful implementation depends on four factors, namely, ownership, leadership, capability and organization. This study also believes that the source and home of the reform is equally very necessary for harmonising these success factors. Ambiguously, the Ministry of Finance (see organisation chart in chapter IV, Figure 8) is the home of Finnish Government personnel reforms including this Vision 2012 understudy. But when identified departmentally, it is the Office for the Government as Employer, a functional area responsible for HRM/personnel management of the Ministry. It is a Director-General office reporting to one of the two permanent under-secretaries in charge of Public Administration and Local Government subordinated to the permanent secretary. With the other six functional areas, the idea behind this marriage thought to enhance better steering, coordination and synergism of all public administration issues comprehensively (OECD 2009; 5).

The OECD (2010) affirms the inter-ministerial power play in Finland falls mainly between the Prime Minister's Office and the Ministry of Finance; with the most uncooperative and inflexible department of all being the Budget Division. The situation is further exacerbated by

the fact that its two divisions have two different political leaders from separate parties in the coalition government (OECD 2010). Such knowledge of the organisational environment and policy planning and implementation stakeholder participation is necessary. But Vision 2012 stakeholders as mentioned earlier turn to be solely civil servants action and the document shows not the basis for its composition (MoF 2003). Bryson (2004) shows a couple of techniques for organizing stakeholder identification and participation namely, a process for choosing stakeholder analysis participants; the basic stakeholder analysis technique; the power versus interest grid; the stakeholder influence diagram and the participation planning diagram. Power and interest are 2 main determinants factors of these techniques. The other 2 are clarity of the purpose and flexible guidance of the process requirements. The power against interest grid is shown in Figure 10 below suggesting how it assists planners and implementers to identify the interests and power bases to consider if a problem or issue at hand is to be resolved comprehensively. This relationship yields four grouping that have much to do with the situation. From the figure it follows that the: i) players – have both interest and significant power; ii) subjects – have an interest but powerless; iii) context setters – have power and minimal interest; and, iv) the stakeholder crowd – possess either minimal interest or power.

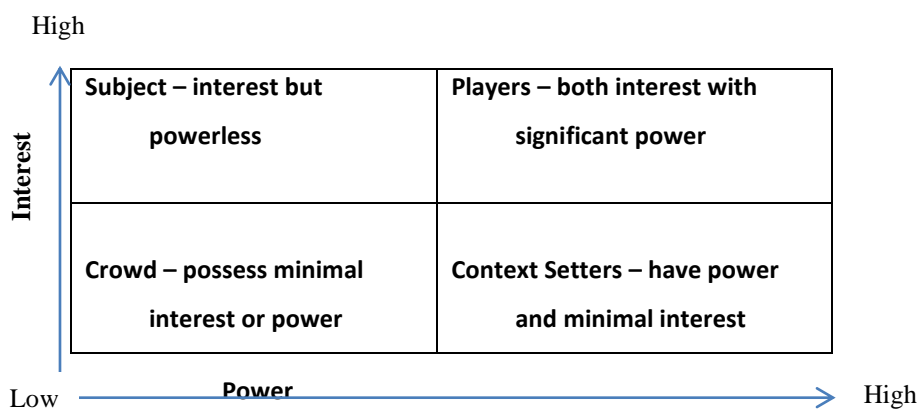

Figure 10: Power against interest grid sourced from Eden and Ackermann (1998 in Bryson 2004)

From the power play versus the interest observed following this grid explains better results of the team composition. In this case, the core group members of the formulation and design project of Vision document (MoF 2003; vii-viii) were from Ministry of Environment, Finnish Maritime Administration, Senate Properties, Population Register Centre, and Finnish Negotiation Organization for Academic Professional in the Public Sector. Respectively, they are a permanent secretary, a managing director, 2 director-generals and an adviser to a

director-general forming the 5 core decision-making group. The support to this group came from Ministries of Finance (4 advisers and a senior officer), Agriculture and Forestry (1 training manager), University of Helsinki (1 research manager) and HAUS (1 development director). The real match makers thus players and context setters either by rank/position or institution seemingly are missing completely from the composition list.

Neither representation was made from the Prime Minister's Office or from the Minister of the Finance section where power is thought to belong. The policy is developed following the least resistance path (Dunsire 1990). It may confirm the informal pattern that fails to build into the well-established scientific public administration system (OECD 2010; Vartola 1999), as a result of fragmentation, hostility and resistance. It illustrates the Finnish Government's horizontality (Peters 2006; MoF 2002), as the political and other top manager power players look elsewhere. The document fails to be a top notch product accepted by all or the context setter or the players, and would not be a "formal" reform document as such. This pre-suggests a hurdle for rough implementation ahead as a result of this failure of power-interest grid consideration.

2.0 The Implementation Strategy of Vision 2012

Implementation is that part of governance process that involves activities in relation to public tasks that follow the legitimate, directive decisions on those tasks, with its scope falling between what happens between policy expectations and perceived policy results (Hill and Hupe 2002). Its processes include 1) assembling the elements required to produce a particular programmatic outcome, and 2) the playing out of a number of loosely interrelated games whereby these elements are withheld from or delivered to the program assembly process on particular terms (Bardach 1980; 57-8).

Although a complex process but simplistically, Brunsson and Olsen observe implementation takes time and reformer's ideas are not stable which may lead to a pace between the development of ideas and the development of practices. They define implementation as a process by which reformers' ideas are put in practice. Between these continuums they consider time lapse and the consistency between ideas and practice thereby establishing four different strategies of implementation as follows: 1) Implementing the reformers' original

ideas. That is, with strong registration of the reform ideas at the start and no further contact with reformers as reformers new ideas may distort the original ideas; 2) Reformees trying to extract the reformers future ideas in advance, while at the same time adapting to them. Implying the reformees thinking becomes strategic as that of the reformers; 3) adapting ideas to practice which can be simplified by, but does not presuppose, ambiguity in ideas and practice – 1, 2 & 3 analysis suggest more of Vision 2012 hands off implementation style; and, 4) isolating reform from operations, by, for instance, reforming the environment rather than the organization itself (Brunsson and Olsen 1993; 126).

Brunsson and Olsen further categorized into two, the “past” and “present” ways of implementing policies as seen below of Table 1:

Table 1: Brunsson and Olsen (1993) Implementation model

Past	Present
Wait for orders	Test, experiment, suggest
Cover oneself against errors	Act – take risks
Punish whoever was responsible	Reward whoever takes responsibility
Mind your own business	Feel involved
Protect territory	See the whole
Get detailed information	Share objectives

The paper analysis so far may put Vision 2012 in the past category of the Brunsson and Olsen’s table; for example, failure to walk informality into formality, silos well protected, and nobody seems to see the whole but the empirical analysis (chapter VII) would clarify better. Primarily, successful implementation thus depend on the design and the adoption of various implementation structures that coordinates and manage implementation activities along with the continuation or creation of a coalition of committed implementers, advocates and supportive interest groups (Hjern and Porter 1981 in Bryson 2004; Peters and Pierre 2003). Bryson then warns, in view of these increased and interconnectedness organizations must think, act and learn strategically; translate their insights into effective strategies to cope with their changed circumstances; develop the rationales necessary to lay the groundwork for the adoption and implementation for their strategies; and finally, build coalitions large and strong enough to adopt desirable strategies and to protect them during implementation.

A brief comment on the measures and implementation is worthy of the on-going flavour. The entire logical framework analysis (LFA) would need to be commented on. Items such as

timing and the assumption/risks are the picks. Below is Figure 11 which is a summary of Vision 2012 from decision principle to implementation with timelines (details not shown in figure). The 6 strategies' 17 tasks and activities were expected to be implemented between 2003 and 2008. Item 8, *Government Resolution*, perhaps, having sought political support was published in 2008 instead of 2005; and, lately 2007 *Guidelines for the transfer of an official to the service of another employer* was published. Item 10 was supposed to be the last on the ground that is from 2005 to 2007. Interestingly, the Ministry of Finance apportioned all the 17 implementation tasks to itself; all being paper work but for the establishment of the joint services unit that would coordinate the processes of the strategies. It is not clear if the others are to follow this timing too as the document merely argues as repeated severally that 'it is up to them' (the ministries and their departments and agencies) to implement the policy. Besides, the name 'Ministry of Finance' (constituting 7 different specialist departments), it is too ambiguous to conceal the precise actor's identity of any particular individual task centrally to NPM/HRM and performance management reform requirements (Reichard/PUMA 2002; Taylor 2001).

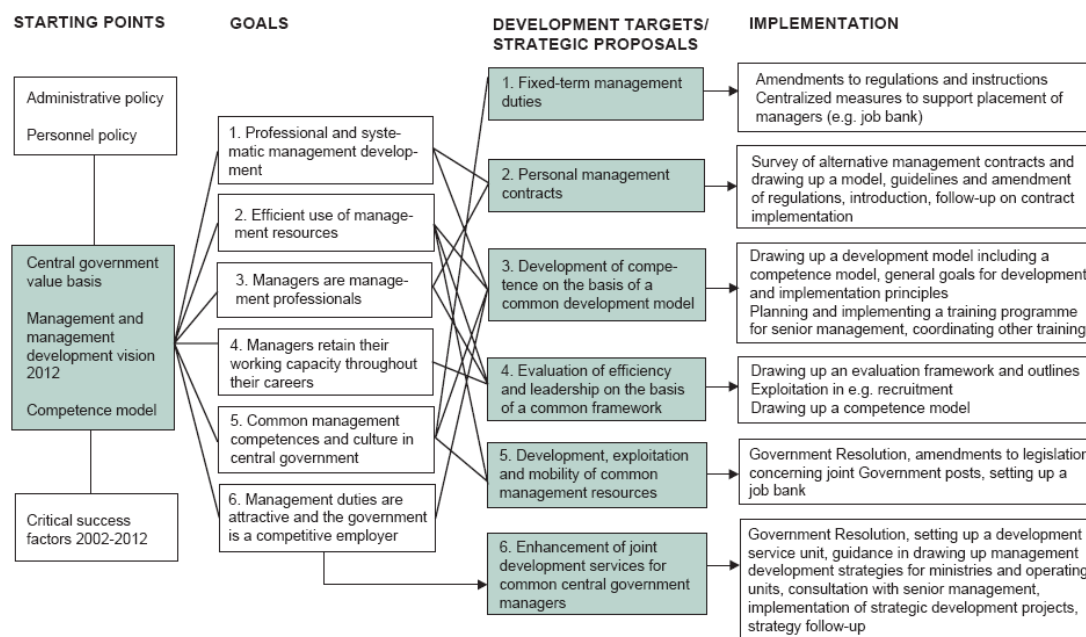

Figure 11: Summary of Management Policy and Implementation plan adapted from Ministry of Finance (2003; 41)

Between 2009 and 2011 at the time of interviewing and writing the joint development unit supposed to be established in 2004 was still nowhere on the ground. This confirms the implementation gap suffered by all governments (Rhodes 1997). Also, literature (example,

British Department for International Development) suggests the assumptions/risks column of the matrix of the Logic Framework Analysis depict events, particularly, external that could jeopardize a project/program and its goals, purpose, output and activities that may be beyond its control. Such a thing is supposed to guide and warn as well as provide alternative solution should the unthinkable turn to be possible. But in the case of Vision 2012 implementation plan finance failed to appear there in the column but seeking political will did significantly. Perhaps, knowing very well it did not exist at the formulation stage. But Vision 2012 failed to show how it is acquired on the plan.

Implementation could even be more problematic as The Vision 2012 document and fliers sighted in totality lacks instructions or directions. Mountjoy and O'Toole's (1979) Theory of Implementation (in Younis and Davidson 1990) is clearer on how implementation process is affected by the provision of resources and the specificity of instructions. The argument stems from the fact that for instance, Vision 2012's move from 'expert to professional manager' is a difficult undertaking from such established routines to a new and unknown behaviour. It requires resources and instructions to do so. In their theory grid, one of Mountjoy and O'Toole conclusion is that without these necessary resources and specific instructions it would normally be expected that there would be the least direction of all; and could also lead to subversive activities as the administrators/leaders would prioritise according to their own judgement and satisfaction (personal interests). Other subversive interpretations could be that with new resources but vague instruction turns to be recipe for divergent worldviews; likewise lack of resources and vague instructions that could pave the way for voluntary actions. Implementation is relatively improved with new resources and specific instructions, they argue. Thenceforth instructions and resources minimise derailing implementation processes.

3.0 The change agent or consultant's role

The Government as Employer Division/Ministry of Finance is the reformer of the Finnish public sector human resources management. The above power-interest grid analysis put them as mere subjects because of their high interest in the reform with little or no power [which they plan to seek through political support during implementation]. Considering the unit as the change agent for that matter then a preview at the change agent's role is necessary at this

point as they have constructed the Government Managerial Vision 2012 but throwing implementation at the ministries and their agencies while staying aloof. Gummesson argues that change agent is an analyst, project participant, catalyst, and interventionist, also perceived as a contingent consultant and is evaluated by results caused due to change not by methods. To bring about change, it is necessary researchers-consultants play a role in decisions and implementation of change and do not limit their participation in the preparation of analytical material as that may be the simpler task. The Finnish Government Reformers seems to recognise that and offer facilitation role where necessary (Turunen, Karjalainen and Metsäpelto 2006). But nothing of the sort is sighted so far in the documentary analysis. Hence, “the change agent ought to be able to participate in all of the constituent parts of this process” (Gummesson 2000, 43).

Cockman, Evans and Reynolds argue (1999; 3) “consultants are [p]eople who find themselves having to influence other people, or advise them about possible courses of action to improve the effectiveness of any aspect of their operations, without any formal authority over them or choosing not to use what authority they have”. Gummesson as well as Cockman et al. make passionate appeal to the consultants to, at least, be involved at the start of the implementation process. The reason is that consulting in itself has reformed from providing expert solutions to helping clients to understand and to take control of their own problems and solutions. While Cockman et al. talk about client-centred; Schein (2004) prefers process consulting in lieu of expertization. Cockman et al.’s (p.5) client-centred is summed as follows: Implementation phase is when the change starts to take shape and people do things in the desired form.

To Cockman and his colleagues, factors such as ownership, leadership, capability and organization do matter; and, failure to handle the four factors may yield signs and actions of low client commitment manifested by anger and hostility; objections; unwillingness to look at the options; unwillingness to look at the process issues; hidden agendas; delaying tactics; and failure to implement (remember Bardach Implementation Game Theory in chapter 3). Citing Blake and Mouton (1976; 1983), Cockman et al. (1999, 22-23) agree distinct intervention styles employed at different phases of the consultancy process are acceptance, catalytic, confrontational and prescriptive. They explain further that in the acceptance style phase, the consultant empathizes with the clients by listening and providing emotional support. To the catalytic phase of work, the client is more involved in the process such as data gathering, making sense out of it, and even arriving at own solution; by that makes it a sort of diagnostic

type. With the confrontational style of work clients are made aware of discrepancies between the values and beliefs they possess. Finally, with the common prescriptive style clients are listened to, data is collected and analysed, solutions found and recommendations proffered.

From another view point, Bryson (2004) continuously emphasizes that strategic planning is never a substitute for effective leadership as both contents and processes require effective leadership. However, the strategic group of Vision 2012 is disbanded and replaced by the output document for implementation although lacking of any communication plan of the instruction and resource back-up plan. Bryson then discusses leadership guidelines, communication, education and personnel necessary for implementation. Leadership: To Bryson and Crosby (2005; Bryson 2004) leadership differs from individual leaders as the same people are leaders some of the time and, at others, are followers in a strategy change cycle. Leadership is the inspiration and mobilization of others to undertake collective action in pursuit of the common good. They argue the interconnected leadership tasks are worthy if strategic planning and implementation are to be effective and based upon the following:

- Understanding the context

- Understanding the people involved

- Sponsoring the process

- Championing the process

- Facilitating the process

- Fostering collective leadership

- Using dialogue and discussion to create a meaningful process, clarify mandates, articulate mission, identify strategic issues, develop effective strategies, and (possibly) develop a vision of success

- Making and implementing policy decisions

- Enforcing norms, settling disputes, and managing residual conflicts, and

- Putting it all together

Importantly, from the above is much said about leaders as change agents, leadership and styles as well as commitment. This falls in place with the chapter III literature and the reform under investigation – the Finnish Senior Management Development (MoF 2003). This study is of the opinion that these success factors would work based on how the reform policy is communicated via the implementation properties (Vedung 2002; Lundquist 1989) as well as identifying the administrative inertia (Brunssen and Olsen 1993) which so far shows unwillingness and uninformed theoretically especially for the context setters and players.

Putting the wrap together, Vedung (2002) contends Administrative willingness is necessary for successful implementation.

3.1 The Role of (Public) Administration in Implementation

Management and Administration have been used interchangeably but are different by definition and function mutually (Keeling 1972; Lynn 2003; Pollitt and Bouckaert 2004; Flynn 2009). Starting from Hood's perfect administration quoted in Younis and Davidson (1990; 6) is symbolic as well makes the administrative role stand out in the study. The model of perfect administration is "a condition in which external elements of resource availability and political acceptability combine with administration to produce perfect policy implementation (Hood 1976; 6)." The concept base elements as recalled: a) the administrative system need to be unitary synonymous to a huge army with a single line of authority; b) the systems norms or rules need to be uniform while the 'given' objectives should be clear and ascertainable to all officials; c) Perfect obedience and/or perfect administrative control; d) Perfect communication and perfect coordination between administrative units; and e) the absence of time pressure. Caiden's (1995) J-Curve excessive action stands opposite to this perfection. Between this continuum lies Simon's (1997; 3) Administration whereby a group of people [such as Vision 2012 subject reformers] with purposive and determined method to "getting things done".

Dunsire sums up and describes Weber's bureaucratic structure of administrative organisation to be of a twin principle of hierarchy and specialisation; arranged both horizontally and vertically in pyramidal ranks but alterable for governance (Dunsire 1990) and implementation being its integral part (Hill and Hupe 2002). Policy conversion or administrative governance follows simple system models in political science view of public administration (Vedung 2002). Or transforming policy objective into real world changes starts with **operationalisation** (Dunsire 1990; 20; emphasis added): That means, communication between specialisms needs species of "translations and interpretations" between one specialised language and another; and along both horizontal and vertical grids of the bureaucracy. By this process the incoming reform idea is said to be translated into a "habitual language" that a local office or unit understands and can act on culminating into Senge's (2006) organisational learning, and shared common language (Morgan 2006; .Shein 2004).

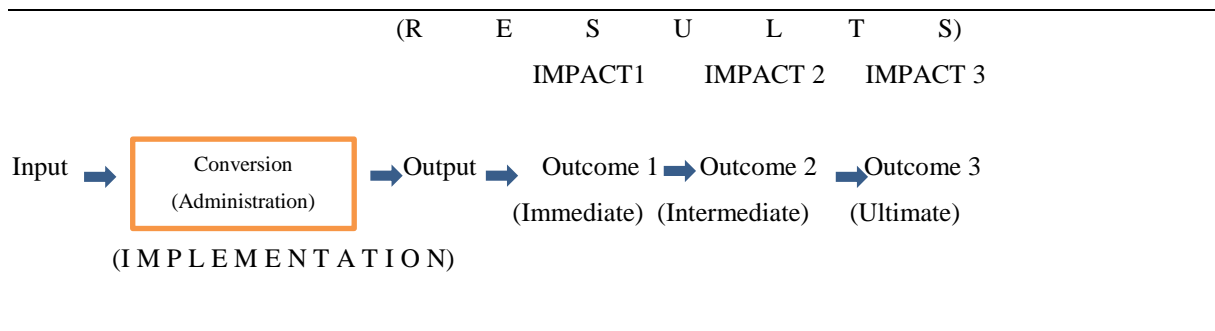

Figure 12: The System Model Adapted by Vedung (2002; 5) for Government Intervention and Evaluation

The implementation processes of conversion and output combined as shown diagrammatically above in Figure 12. The diagram lays out clearly the paths of the implementation and impending Government evaluation envisaged in 2011 (MoF 2003; 2008). Vedung’s broadly viewed political administrative governance is sub processed into administrative and evaluative controls. While the latter is a retrospective action, the former “is the means used by an organization to elicit the performance it needs and to check whether the quantities and qualities of such performance are in accord with organizational specification” Vedung 2002; 5). Keeling (1972; 34), on his part, perceives administration as “the review, in an area of public life, of law, its enforcement and revision, and decision making on cases in that area submitted to the public service.” This is consistent with the view of decision-making enjoins with the doing processes (Simon 1997), and continuous implementation communication.

The synthesis here suggests administrative action must be shared responsibility and centrally led responsibility despite the different functionality but lacking in NPM/HRM reform and implementation (Taylor 2001). However, defining output as what government servants do in order to give effects to the policy intention of government; and outcome is, in fact, what happens in the real world when they do it (Dunsire 1990; 15). Between these two concepts (see Figure 11) Dunsire identifies gaps: between input and intention, and outcome and intention. The concern of this study is to understand both the input/intention and the gap between it and the output via the processes. The paper analysis to this point has already yielded evidences including unwillingness and poor reformer preparations of both policy and implementation processes of that gap between input/intention. Their interpretation, interaction and actions of the input define the administrative role and processes amongst themselves.

3.2 The System Resource Model

Following the above review of administrative role and processes what should be clear is that organisations do not act on their own but for the people involved, especially, the managers. Loveless and Bozeman (1983), for example, demonstrate the power and influence a manager can exert in organisational process while Nigro (1983) dealt with the organisation. It would be appropriate to posit a plane for such skills, capabilities and actions of the manager as the Systems Resource Model; propelled by organisational-environment relationships. Its proposition: All human organisations are open systems that must continuously transact with their environment (acquire inputs and dispose of outputs) if they are to survive (Nigro 1983; 281). Nigro argues that organisations do vary in the manners that are used to convince outside agents for political support, skilled employees, finance and material on permanent basis. That ability of an agency to acquire these resources, Seashore and Yuchtman (1967 in Nigro 1983) labelled as external extraction capability. This capability is taken for, the public manager's ability to induce and control innovation (Loveless and Bozeman 1983).

On their part, Loveless and Bozeman agree that it is the public manager or some other actor above who is responsible for identifying the cues for performance gap, the capability to bridging it and its requisite resources from within and out of the organisation and its environment. In organising the innovation it requires innovative processes of interactive relationships of which the manager has no control but of key influence (also, Morgan 2006; Schein 2004)). Organisational size, timing, quality, costs and benefits (social, political and financial) were enumerated for reform successes. They observe that the characteristics of the innovation provide the ability of the manager to control information as an incentive to change to all other actors concerned with the process. These organisational actors were further categorised based on roles as follows: Initiators, advocates, ratifiers and acceptors. To illustrate with Vision 2012 reform: The formulating and design managers of Government as Employer Department took the initiative following the NPM/HRM wagon of the 1980s when the government manager needs became apparent; having considered its cost and benefits and; supposedly by that convinced Government to accept as well as rectify and paving the way for its implementation system-wide - size. Once again these roles of advocating, acceptance and other further ratifications that might have been made for effective implementation communication remain to be picked off from the empirics in the subsequent chapters.

Loveless and Bozeman found further that organisations having strong communication ties with external actors turn to be more innovative; for that matter Managers ought to ensure communication and information management with their external environment; as well support the development of ‘gatekeepers’ with the ability to scan wide and select relevant information; more importantly pass information to professional colleagues. Furthermore, keeping a warm inter organisational relationship (also Pfeffer and Salancik 2004) requiring of the manager critical political skills was recommended for success of innovations (Pfeffer 1972). At the start of the innovation communication has taking the usual informal way as analysis above showed of Vision 2012. What remains in the process communication at its advanced stages according to Loveless and Bozeman concern bargaining and accommodation, feedback on outputs; and, internal communications are equally critical to the process. The external capability of the public manager to communicate for influence of an intervention is dependent on, the complexity or difficulty of understanding it as well as the availability and usefulness of its information (Loveless and Bozeman 1983). Perhaps, this is the ‘cognitive’ side of ‘the human factor’ of implementation about how we learn, and communicate, and understand (Dunsire 1990; 15); in order to improve Simon’s individual’s rationality or unbound his/her limitation in capability and performance. Arguing further, that decisions made at the top level over and above operatives must be communicated for skills, values and knowledge; for a policy’s quality is determined by the environment that bounds the rationality of the decision maker; in so doing, the fundamentals of organisational theory development are brought to bear (Simon [1945]; 1997).

4.0 Communication and Implementation Properties

The public administration practitioners’ concern is “constant need to answer questions about how to act. Appropriate answers in the new world of governance have to be framed without that clear privileging of specific answers” (Hill and Hupe 2002; 200). Much as Loveless and Bozeman (1983) would recommend relevant information generation from the reforms by its managers; or relevant determinant criteria (Simon 1997); so do Lundquist (1989) and Vedung (2002) put emphasis on the properties of implementation to the reformers, reformees and even the institution as a whole; to include its environment (Brunssen and Olsen 1993). In a restated and broad manner following the discussion so far the study concern is how effective have these useful

information been generated and communicated instructively, and ostensibly consistent within and between the Personnel Department/Ministry of Finance/Government (the reform owners) on the one hand, and to the other, the implementing ministries and agencies; and among all the actors responsively?

Information is replacing authority and at the same time the key to production as such Peter Drucker calls for intolerance of intellectual arrogance of professionals and knowledge workers. Mutual understanding can never be attained by “communications down,” can never be created by talking but results only from “communications up” [and laterally]. Implying that it requires both the superior’s willingness to listen and a tool especially designed to make lower managers heard (Drucker 2008, 265); or uniting the top-down with the bottom-up (Pettigrew et al 1991) for implementation. In their Finnish service sector studies Aaltonen and Ikävalko (2002) found top-down linear communication prevalent. They explained that the interpretation, understanding, acceptance and adoption among implementers are incomplete and difficult despite finding plenty of reform information around. They call for more informal communication over formal, and a two way communication with feedback and reaction to bottom up information (Aaltonen and Ikävalko 2002; 417); and of the lateral.

Evert Vedung contends “implementers must understand the intervention, be capable of executing it, and be willing to do it” (Vedung 2000; 227). This study, therefore, focuses on looking at these properties of implementation as the study scope and to include culture due to context as that has the ability to affect any reform either positively or negatively; and, culture makes the reform policy unique. With this scope brought together and how they were/are, communicated between all parties involved (Al-Ghamdi 1998; Loveless and Bozeman), in this prevalent top-down implementation system (Aaltonen and Ikävalko 2002) but without a communication plan. This is arrived at having thoroughly gone through what prior to have been labelled barriers to implementation that are being sieved from time to time since 1985.

In recent times, Holbeche (2006, 300) documents why change efforts fail as follows:

- Change/implementation took longer than originally allocated, only released benefits in certain areas or was never completed;
- unforeseen problems surfaced at implementation;
- poor coordination of implementation activities;
- Competing activities and crises distracted attention from implementation;

- Capabilities of employees involved were not sufficient;
- Training and instruction given to lower-level employees were not adequate;
- Uncontrollable factors in the external environment had an adverse impact on implementation;
- Leadership and direction provided by departmental managers were not enough;
- People, often already overwhelmed by their workload, became cynical about the likelihood of change effort succeeding;
- Organizations usually are not able to deliver their core strategies due to high levels of resistance;
- Failure to define implementation tasks and activities in detail and clearly;
- Information system used to monitor the implementation were not enough;
- Limited genuine organizational and individual learning took place, leading to over-reliance on external support;
- Leaders credibility was undermined as they over-promised and under-delivered.

While Altonen and Ikävalko (2002) listed five items: organisational size, tenure, organisational levels, organisational types and education; Al-Ghamdi (1998; 323) cites the source as Alexander's (1985) chronicling 15 potential strategy implementation problems as listed below:

1. Took more time than originally allocated
2. Major problems surfaced which had not been identified earlier enough
3. Coordination of implementation activities was not effective enough
4. Competing activities distracted attention from implementing this decision
5. Capabilities of employees involved were insufficient
6. Training and instruction given to lower level employees were inadequate
7. Uncontrollable factors in the external environment had an adverse impact on implementation
8. Leadership and direction provided by departmental managers were inadequate
9. Key implementation tasks and activities were not sufficiently defined
10. Information systems used to monitor implementation were inadequate
11. Advocates and strategic decision makers left the organisation during implementation
12. Overall goals were not sufficiently well understood by employees
13. Change in responsibilities of key employees were not clearly defined
14. Key formulators for strategic decision did not play an active role in implementation
15. Problems requiring top management involvement were not communicated well enough

The argument by this study is that most of its findings are in these listings which are preventable provided the grounds work is well done. That spells why this study opts for what it labels ***Implementation Communication to embrace the properties of implementation and expands it to include culture forming the fundamental basics of the subject of implementation.*** This means to start with, the leadership must have a feasible reform idea

that must contain a vision (Behn 1991) well understood. Behn further establishes that this idea is adaptable and not easily transferred (culture). Perhaps, this is why Fukuyama warns of adapting best practices from different contexts or settings (Fukuyama 2005). This is viewed as a transfer of one culture to another. Considering the properties, therefore, is necessary and should be well defined and blended taking the destination environment into account. The idea is then shared, ostensibly communicated consistently and upgraded with time depending on the managerial and institutional external extraction capability as well as following the systems resource model (Loveless and Bozeman 1983; Nigro 1983) through the systematic approach (Schuler and Jackson 1996). The following briefs expatiate upon the properties of implementation forming the Implementation communication conduit of the study to be used as the criteria for assessing the Vision 2012 processes:

4.1 Understanding:

Reforms imply beneficial change from a deliberative move, from a less to a more desirable state in the future. And, if they are to be understood then they must also be considered as processes of debate to which different participants may bring, first, different objectives (including the achievement of symbolic purposes) and, second different frameworks and standards for identifying and accepting relevant ‘evidence’ (Pollitt and Bouckaert 2004). To do all that, information must reach the target group or it does not work (Vedung 2000). A short note is more appealing to Sir Richard Branson of Virgin the largest European Conglomerate; phone calls and emails are a waste of time; and: “There’s no question that if you are trying to persuade someone to join you, invest with you, or make some changes, then it’s important to speak to them directly and take the time so that they know what they must do. Face to face conversations are more efficient, and videoconferencing will always come a poor second to a shared pot of tea” (Branson 2008; 97). This instance ferments Herbamas (1984) Theory of Communicative Action’s verbalisation in constructing understanding democratically. But fast and fashionable emailing seems a dominant managerial culture change (PUMA 2003; Mintzberg 2009).

Scientific understanding according to Morgan is the ability to recognize the amount of different phenomena that actually form part of a coherent whole just as in genuine terms it transcends beyond complexities margins to the bottom revealing fundamental patterns. His recipe for “reading” to understand a situation requires activism, and use of imagination, metaphors, multi theories and methods (Morgan 2004, 364-5). Change agents or consultants must provide theories to explain for understanding (Cockman et al 1999). Therefore, strategic thinking, acting and learning (Bryson 2004), to read and understand organizations is a

competency for effective managers (Morgan 2006), in the implementation process. In fact, it is the basic duty of the administration/administrator to ensure each and every individual member is enoughly equipped with the environmental decision rational from the organisational/group situational value and consistent with the individual's rationality (Simon 1997; Reichard/PUMA 2002).

4.2 Willing:

“Political will”, a very popular phrase these days, denotes the determination of a government and politician mostly; and that: “Strong, directive, and above all persistent, executive leadership is longer but more accurate” (Rhodes1997, 88). Public interest or will as well as individual will was accounted and responsible for the successes of absolutism (Lynn 2007) as noticed in the previous chapter III. Will, is found in Manager Development as first and foremost the responsibility of the individual as self-motivation (Drucker 2008). Will is further elaborated using Perry and Wise (1990 in Pollitt 2003, 144) threefold categorization of motivation: 1) Rational – what will I get out of this, 2) Norm-based – what do I need to do to conform to the prevailing norms around here? 3) Affective – how can I support this program that I believe in? Or, how can I fight this evil (hunger, crime, avoidable ill health, etc.) that I want to defeat? Importantly, Pollitt (2003) observes as mention earlier on that only the rational finds its way into economic models of individual and organizational behaviour; albeit the primacy of economics in development is long gone (Soggy 2002; Fukuyama 2005).

In terms of Values, (also, discussed already in the third chapter) they have the propensity to elicit judgement and action (Bozeman 2007). Action becomes Will based (Colvin 2008; Sennett 2008; Olivecrona 1971). Will, therefore, is seen as free and voluntary of the actor. Not only in politics but Will is both an anchor and powerful tool in the legal world. The Will-Power Theory (*Willensmacht*) Olivecrona found in Savigny to be a right; a power belonging to the individual; and, an arena wherein the will is ruling based on consent of others. Will in itself is a creative force, important and operative; with a manifestation of the will show to others in observable behavioural actions (Olivecrona [1939]; 1971).

Leader's language becomes necessary (Pfeffer 1997; Pettigrew, Ferlie and Mckee 1993); amidst communication difficulty (Simon 1997; Wojciechowski 1978); and more importantly, appealing for consent. Kotter (2002) demonstrates this emotional appeal better:

“The flow of see-feel-change is more powerful than that of analysis-think-change. These distinctions between seeing and analysing , between feeling and thinking, are critical because, for the most part, we use the latter much more frequently, competently, and comfortably than the former”. This Kotter view seems better associated with the rational-analytical value and a factor dominant in silo-slab system. In as much as the reactions of the implementers are crucial for success so do the need for *zealots* actors amongst them. These are people who are strongly committed to the cause, willing and capable to commit their time and energy to it. Thus the exchange of actors in a collective entity becomes of importance. Zealots come with effectuality to organizations and programs (Vedung 2000); not leaving out the local proud Finnish *sisu*, of having guts. In totality, while Vedung (pp.227) talks about *administrative willingness*, Sennet (2008) puts it that well-crafted institutions influence implementation outcomes positively. Administrative willingness holds that civil servants may have doubts about the policy appropriateness; perhaps, due to poor sharing and communicating its conduit properties to the operatives. Effective communications of the policy becomes inevitable therefore (Drucker 2008; Altonen and Ikävalko 2002; Habermas 1984/2008; Hasenfeld and Brock 1991; Simon 1997) as well as feedback for redress (Hasenfeld and Brock 1991; Vedung 2002) to extend rational bounds and improve capability and performance.

4.3 Capability:

Capability is both person and organisation focused when skill, values and information are well communicated and shared. It starts with self-appraisal based on performance objectives and it requires active leadership by the manager in Drucker’s (2008) view. Knowledge and information are the chief sources of skills and capability (Wallin 2003). Capability comes in as the ability to do something well as such new skills and competence are required to accomplish the change. This is of a three component part: a cognitive or knowledge level, a doing or behaviour level and an affective or feelings level. With organization it implies implementation is well planned giving attention to [individual work] team work, conflicts and cooperation, communication, and rules and procedures (Cockman et al. 1999) or providing ostensible instructions and adequate resources [Mountjoy and O’Toole 1979].

Observing from chapter three analysis of the fragmentation factors it is wise to agree with Senge (2006) that team work development is more difficult than that of individual. The program’s time of adaptation to the decision situation of the addressee is a capability factor

that may explain its outcome. This means if reform intervention arrives at the formative moment it certainly attracts attention and results produced (Vedung 2002). Motivation and ability has been sighted by Hanson (2009). But Passion or motivation alone may not be enough to bring about the necessary will; put alongside deliberate practice are the source of capability for innovation and performance (Colvin 2008; Sennett 2008; Mintzberg 2009).

4.4 Culture:

The rationale here is that culture tends to be the source of values. It is so because organizations or institutions are a cultural, historic, contextual and evolving phenomenon as the discussion testifies so far. Thus, for example, the Finnish culture is holding both traditional values against new economical values (Ikola-Norrbacka and Jokipii 2010). Also noted in the second chapter, culture was pointed out to be avoided or taken for granted in organizational studies (Pfeffer 1997; Fukuyama 2005) or treated mechanistically where it is even considered (Morgan 2006; Schein 2004). More importantly, Morgan adds, it also has the property to create “blindness” and ethnocentricity as well as taking into accounts political flavours. Culture – national culture - is rarely uniform although much is shared in common (Morgan 2006; Schein 2004). Cultural studies provide meaning and understanding beyond artefacts to include power embedded in any social life from traditional to contemporary (Calhoun and Sennett 2007). Importantly, [a] “focus on the links between leadership style and corporate culture often provides key insights into why organizations work the way they do” (Morgan 2006; 131). It is also established that understanding the political culture is necessary for any reform success (Blanning 2002).

With such understanding, it is really important to recognize that formal leaders do not have any monopoly on the ability to create shared meaning (Morgan 2006) but they may be influential (Loveless and Bozeman 1983; Morgan 2006) by the leader’s position of power: That may lend him/her a special advantage in developing corporate value systems and codes of behaviour because formal leaders often have important sources of power through which they can encourage, reward, or punish those who follow their lead. There are others too who are able to influence the process by acting as informal opinion leaders or simply by acting as the people they are. Culture is un-imposable on a social setting. Automatically it develops during the course of social interaction. Culture as an implementation property provides broad and in-depth insight of the situation at hand, the role of the leader, identification of barriers to

implementation, refreshing the leader own mind-set, effective change all depends on changes in the images and values that are to guide action (Morgan 2006; Blanning 2002). This is consistent with the silo-slab analysis (Mintzberg 2009) and its associate insular culture (Hansen 2009; Riggs 1994).

Mintzberg's (2009) take on culture is that it places the manager as the energy centre and for this reason culture is the decision shaping form of leading the organization. For Morgan and Schein the fundamental task facing leaders and managers rests in creating appropriate system of shared culture and observing what leaders pay attention to. Cultural control with the internalization of values from peer enforcement resolves rebellious behaviours (Pfeffer 1997). Therefore, Vision 2012 chose appropriately the culture change and reformer self-chosen-value needs rather than society's present need, yet the system remain fragmented almost a decade of its implementation. The compelling challenge is to empirically understand this phenomenon.

Morgan's culture metaphor: Its message is that change programs must give attention to the kind of corporate ethos required in the new situation and find how this can be developed. Since organization ultimately resides in the heads of the people involved, effective organizational change always implies cultural change. Culture has a holographic quality that is arguably is the major source of power as a factor influencing effective management. Holography demonstrates that it is possible to create processes where the whole can be enclosed in all the parts so that each and every part represents the whole, a brain image view. This is where the reformers are supposed to fish out both the positives and negatives of the culture and mindset that could thwart the change process.

Morgan observes holographic aspects of organization are always asserting their presence but in many situations they are suppressed or negated by conventional assumptions about organization design. The holographic quality or style of organization is self-organizing, emergent phenomenon. It all depend on 5 principles: build the "whole" into all the "parts" – Corporate "DNA", network intelligence, holographic structure, holistic teams and diversified roles; the importance of redundancy; requisite variety; minimum specs; and learning to learn (Morgan 2006) – [necessity of centrality (Caiden 1994; Taylor 2001; MoF 2003)]. This metaphor is used to trace backward to its inception about how the Vision 2012 communication conduit was propagated and disseminated within and to the different parts of

the Finnish Public Administration to understand its corporate culture. This new Implementation Communication tool constitutes these upgraded implementation properties: understanding, willing, capability and culture. It must be the primary core as well serve as the standard of the reform, and for broad scope development and implementation. This must be prioritised over all other external surveillances (Pfeffer 1997); and, talents and motivators (Sennett 2008; Colvin 2008; Mohr 1982) which could serve at best as complementary.

5.0 Political economy service delivery theory

Hasenfeld and Brock's (1991) political economy model is based on the interaction of critical actors, that generates three forces based on the policy instrument to drive implementation process; namely, technological, economic and political. These driving forces are explained as follows: Arguing that the implementation of every policy should involve the technical operationalization of a theory of cause-effect explicated by the policy; thus its program components directly take responsibility for producing the desired changes in the target population. Consistent with discussions above the technological specifications should aim at minimising design errors by making the components of the policy and program as well as how to get things put together into a coherent form.

The justification being the greater the technical rationality and coherence, the lesser the potential for design errors, thereby, maximising the corresponding index of the outcome. Vague policy is noted to encourage implementer's discretion toward own ideology, fiscal and political. This could lead to diffusion of power among policy owners/implementers and stakeholders as competition is encouraged and actors promote own agendas [These have been observe in the earlier analysis to be consistent with silo activities].

On the economic consideration cost was the ultimate determinant factor. Thus, the availability of resources, the elasticity of demand and supply of these resources required by the policy/program implementation, and the inelasticity of the demand for, or the supply of the resource needed raises the power of stakeholders possessing these resources. This could explain the poor and incoherent relationship between the Finnish Prime Minister's strategic development plan and the Budget Department thereby affecting implementation and governance (OECD 2010). Three types of cost consideration are deduced in the

implementation process: production costs, opportunity costs, and transaction costs. Success is based on well communication, coordination and monitoring notwithstanding the cost level.

Political or power relations were found to be the context in which cooperation and compliance for implementation vested. Hasenfeld and Brock argue that concentrated power is greater commitment to program and mobilizations that leads to greater correspondence index. Astley and Sachdeva (1984) were referred to by Hasenfeld and Brock (1991) to support their power mobilisation for effective implementation process: The policy owners and its implementers/stakeholders the preference should prioritise for considerations that leads to concentration of, hierarchical authority, resource control, and network centrality. Conflicts are inevitable in the process; but power is exercised between and among the participants to protect and advance the values, interests and resources. With the implementers in the centre; power mobilisation through the processes of [transforming] competition to bargain, coalition building, cooperation and compliance of the values and interests; and, the consequence, a structural interorganisational network with the implementers in control over the terms of exchanges would yield highest correspondence index.

The political economy model wherein lies the Service Delivery System suggests three interrelated components discussed above: the technical core (the policy example Vision 2012), the interorganisational network (the relationship among the participants: example, top Finnish Government managers/politicians, the top private/third sector managers and the governed or society at large) and the control mechanism of the program may be structural (facility adequacy and the quality of personnel: training institutions - HAUS), processes (number of clients processed by each component example) or outcome (portions of client rehabilitated: example, how many top managers?). All these depend on the degree of interaction and coordination of the elements for its results as shown in figure 11 below. This further means the DNA (Morgan 2006), of the leadership network and collaboration efforts are very strong.

Hasenfeld and Brock's model has been chosen for this study over others due to its elements discussed above. However, it lacks the fundamentals as it fails to tell the 'how' of its processes. Communication and implementation properties are the ingredients needed fit in to complete and activate the model.. They provide the base power, capability and competence,

commitment and compliance, and understanding among all. In this wise, C_m will denote this new comer on the diagram. This, however, does not change the analysis but adds value.

Hasenfeld and Brock hypothesis that Cell 1 will maximize the correspondence index, while Cell 4 will run the opposite and minimize it as seen from this cross tabulation of power dispersion against technical/economic uncertainty. Diagonally, lay cells 2 and 3 describing somewhat to moderately fragmented situations lowering the corresponding index. The empirical analysis is elaborated in the next chapter shows this clearly. Cell 1 is the preferable choice as it maximises the correspondence index, thus the greatest eligibility, processed and served populations and between needs and services. This is as a result of effective communication and coordination as well as feedback adjustments. These elements are sought for from the next chapters following the hermeneutic data analysis. The top level civil servants are the processed.

		Power	
		Concentrated	Dispersed
Certainty	Technical/ Economic	C_m = highly communicated T = highly integrated I = highly coordinated C = structure, process and Outcome (1)	C_m = moderately communicated T = moderately integrated I = somewhat fragmented C = process and outcome (3)
Uncertainty		C_m = somewhat communicated T = somewhat fragmented I = moderately coordinated C = structure and process (2)	C_m = poorly communicated T = highly fragmented I = uncoordinated S = structures (4)

Figure 13: Driving Forces and Service Delivery System adopted from Hasenfeld and Brock (1991)

Note T = technological core; I = interorganisational network; and C = control mechanisms and C_m = Communication and implementation properties

Intriguing about Hasenfeld and Brock's model is the feedback loop generated among the components. In internal adjustment, policy owners and critical actors deliberately alter the

processes mostly due to program monitoring or program evaluation. Feedback could also be generated by such events that go beyond the implementers control; they called that exogenous 'shocks'; examples including political, financial (example, 2008 recession), cultural, technology (internet) and disasters and so on. Changes of leadership and even new entrant stakeholders could all affect implementation so long as the driving forces have been affected. In this case study, running from 2003 under the same President, Prime Minister Vanhanen (I & II) until 2010 when he later resigned; but different Ministers (following 2007 elections), and, of course, changes in the top civil service (alongside retirements). It remains to be found how the implementer and critical actors managed these developments in this multifaceted process of implementation since 2002 to date.

5.1 Conclusion

Vision 2012 reform case was born 2002/3 and implementation has continued to-date (2011 ending 2012 according to the plan – MoF 2003). The reform home and owners are delineated in the Ministry of Finance as well as its controversial implementation plan. The policy design and formulators are analysed to be neither players nor context setters wielding no power required of a lead agency. The public manager is supposed to have influence and very good extraction capability from the environment. The reformer, for that matter the change agent, is placed in the resource system model for the necessary extraction purposes. It is assumed the manager is centrally placed for direction and action with the change agent. Operationalising and defining the gaps and filling them with these extracts were keenly taken care of by communications influence. It is a fundamental standard this study seeks for basic implementation model.

Some well noted possible barriers to implementation were analysed and performance elements discussed to justify the four elements selected for Implementation Communication. Its properties were formulated, elucidated and designed for alignment and the study scope. They are understanding, capability, willing and culture. These elements were revealed from the theoretical analysis consistent with the core of Vision 2012 model. In effect they become the criteria or scope for assessing how the Vision 2012 was communicated for implementation since the last ten years. Potentially, four theories are set for testing this communication tool following the analyses. But the paper analysis places the reforming

agency at a weak subject context where it has enormous interest without the background power to push ahead. However, there is a plan to acquire political will as the implementation process unfolds. Holding on this lack of reformer or change agent political skill at this point the next pages tell the rest of the story.

VI Collecting and Analyzing Qualitative Data

1.1 Introduction

It was identified and indicated in the second chapter that this is a hermeneutical study, a qualitative inquiry brand. Having followed through with its processes in that chapter as far as story, literature context, interpretation and meaning are concerned. Now, it takes to the field's empirical work and how the conduction took place. This chapter reports on the interactive actions at the national apex of the Finnish Public Administration for data on the implementation of the Senior Civil Servants Management Development Program (Vision 2012). Whereas the espoused theory is what people claim to do or its being the official version of what the program or organization operates; the theory-in-use is what occurs in reality (Patton 2002); and, that is what is posited in this section and the next of this report. Interviewing managerial staff and administrators and analysing official documents reveals the espoused theory (Patton 2002). Out of this data content analysis is used to make sense of the material by identifying consistencies and meaning, patterns and themes. Field notes are brought to bear. Following Creswell (2009) single words to paragraphs quotations from interviewees are made to support or refute a concept, argument, theory, or a view as well as **bolding** and/or *italicizing* key words, phrases and sentences for emphases (See sample below but first, the data sources).

1.2 The Data Sources

Interviewing is the best process for culture change (Schein 2004) and implementation evaluation studies (Patton 2002). As Vision 2012 targets mainly top level managers made it mandatory to pick on Government top level managers for the interviews of this study. In all, 37 participated out of 60 contacted starting from the 12th of March, 2009 via emails. It was a thought through of network of implementers for the policy. It took within a day to three months to arrange the appointment session and the subsequent interview; an indication of dealing with top busy executives. The shortest session was 16 minutes and it was one of the two telephone interviews. The longest session was one hour 39 minutes while the rest lasted between averages of 40-50minutes. Mainly, it was a face to face, and one-on-one sessions but for the Johtamistaidon Opisto (JPO) and the Public Administrative Committee in Parliament that turned to be focus-groups of two and four respectively. The interviews started on the

April 7th 2009; and, while the President's office has turned it down, 15th March 2011 (see appendix 2 & 3 for both request and response emails), the former Prime Minister's requests response is awaited earnestly as until this wrap up is over. Both the President and Prime Minister have never been heard talking and addressing this policy and/or (Finnish) leadership before according to interviewees.

Table 2: Sampled Organizations/Ministries and numbers Contacted and Interviewed

Organisation/Ministry	Number Contacted	Number Interviewed	Percentage: %
Finance	17	13	76.4
Justice	4	3	75
Education	5	1	20
Social Affairs & Health	3	2	66.6
Interior	4	1	25
Prime Minister	3	1	33.3
Foreign Affairs	1	1	100
Parliament/Ex-Minister	7	1 (Focus Group of 4)	25
Senate Properties	1	1	100
Helsinki University	2	2	100
University of Tampere	2	0	00
Finnish Negotiations Organisation for Academic Professionals	1	0	00
HAUS	2	2	100
Transport	1	1	100
Presidential Palace	2	1	50
Talent Partners	1	1	100
JTO ry	2	2	100
Private Individuals	3	1	33.3
Total (16 organisations)	60	34/37 including focus group	56.6/61.6

Unfortunately, besides the Parliamentary Committee for Public Administration both present and former ministers associated directly and indirectly with Vision 2012 turned down interview requests. The lack of time and adequate knowledge of policy as it was a long time ago excuses were offered. For example, in the interview process the most popped up political name elicited besides time: “I also doubt that I could contribute anything really relevant to your thesis as my involvement with the project was limited to critical remarks in the socdem [social democratic] group of ministers” (Personal Communication). One out of the six did not even acknowledge receipt at all.

Furthermore, not even at Vaasa University, the 28th September 2009 face to face request from the now prime minister, then “Second” Minister of Finance, and directly responsible for public administration and Local Government worked; although she promised a 20-minute interview possibility; but that never got fulfilled. This was after 3 emails had failed to get any response from her office. These observations made it very hard not to accept the civil servants views that the politicians are not interested and are afraid of the management reform.

Table 2 above shows the 17 institutions/organisations mostly state owned as well as 3 private individuals (an emeritus professor and 2 other professors) contacted for interview. The one respondent professor is a foreign guru of Finnish Public Administration. The other 2 non-respondents are Finnish Presidential Historians. Other details not found from the table include the JPO Oy, Finnish Cultural Foundation and Finnish Literature Society. Whereas the first was contacted for interview due to their manager development functional role for the Finnish private sector since 1946 (JPO Oy Focus Group; <http://www.jto.fi>); the other 2 organisations were contacted by emails for literature on the Finnish conception of leadership. The latter action yielded no response. A telephone follows up to reveal no literature on the Finnish Managerial Leadership subject commissioned. It was no different from the Regional Finnish Cultural Foundation at Ylöjärvi near Tampere; a telephone conversation revealed. It was emphasised that numbers would be used where appropriate for clarity and understanding as Table 2 depicts above and in the text. Talent Partners, a consulting firm was added to the study of network of the Vision 2012 implementers as it was named as one of the main trainers of the Ministry of Finance’s programs besides JPO Oy and HAUS (Interviewee 1). The firm knows about the policy but does not use it in its functions.

Truly strategy does evolve (Mintzberg 2009; Farjoun 2002) but based on an existing one. That of this study was to study 3 out of the 12 ministries vertically, that is, from top to

bottom. By that it was to assess how the reform policy has filtered down the hierarchy, transforming the leaders of the various hierarchical levels; and, thereby improving performance along the ministries and their sectors. The institutions carefully selected were Finance, Education, and Social Affairs & Health Ministries as they are key to every nation building process. Based on researcher's cultural background and re-enforced by earlier education (Master's program in Development and International Cooperation, University of Jyväskylä), entering this community was approached by contacting the Permanent Secretaries as the heads of the Ministries for permission to conduct the study. This was choosing the formal way. The email announcing the requests (see appendix 1) was as brief as possible: introducing the researcher and his supervisor; the Vision 2012 document; potential benefits of the study, duration and, of course, confidentiality and the interview. In view of this, names that appear here have been agreed upon as such. Otherwise, numbers have been assigned arbitrary to represent interviewees beginning with the very first paper cited. She or he does not necessarily mean a male or female but just an interviewee. Appendix 5 is interviewee-list of staff and relevant related participants/observers captured following snowballing process.

2.0 The Reality Construction and Emerging Strategy of the Study

Interviewee 2, for example, recollected at one of their Strategic Society meeting a colleague asked for the meaning of "strategy" and no answer provided was accepted to be correct. The group unanimously agreed to the definition of the questioner as follows: "You can see the organization strategy from where you have put your stakes, money, efforts, activities; but not in documents; vision, mission are all plans; the truth is what you have done, that is the strategy." This view is undergirded by to Schein's (2004) idea of watching what leader's pay attention to as what matters to them and could imply their strategy. Both views and its interpretation from these two interviewees provide a flavour of where to seek truth and reality for a new page having followed the Vision 2012 document up till now. Having reviewed their documents and reform policy, it time to follow this strategic hints on the position of the Finnish Government and Ministerial management stakes, money, efforts, activities and what they have done as their strategy.

It was a two-pronged strategic start, that is, while personal contacts led to the ex-secretary to Vision 2012 disbanded group, the researcher's supervisor's effort to another senior officer at the ministry made it all possible to the rest of the interviewees in the Finance Ministry. In

Education the circumstance changed drastically forcing out a new strategy for the study. Worthy is to follow the five (all but one from different person) correspondences from the Education Ministry:

First mail: “This is a message from the Ministry of Education and Culture with the recommendation of those you can interview. Please, call me.” – from researcher’s supervisor. Now, from the Ministry: ”Hei, Oheiseen opetusministeriön kansliapäällikölle tulleeeseen viestiin liittyen varmistaisin vielä, että Mohammed Ibn Mukhtarin väitöskirjan kannalta on tarkoituksenmukaista haastatella nimenomaan kansliapäällikön alaisuudessa toimivia ylläjohtajia eli koulutus- ja tiedepolitiikan osaston, kulttuuri-, liikunta- ja nuorisopolitiikan osaston ja hallinto-osaston päälliköitä. Kansliapäällikön puolelta asialle ei ole estettä.”

Second mail: “Hei, The best way to proceed with the interviews in the Ministry of Education might be to first talk to Senior Advisor from the Administration Department (Human Resources Division). Her responsibilities include management development issues in the Ministry.”

Third mail: “I have had requests from our department heads to receive a research plan on your study before the interview arrangements. Could you please send it to me so I can forward it on to them?”

Fourth mail: “I discussed your interview request and research plan with the Department Heads and the Permanent Secretary during our two day management group meeting last week. We unfortunately failed to find a specific link with your research plan to the educational and cultural government sector. That is why we thought it would best benefit your study if you held the conversations with Mr. XX and Ms. ZZ from the Administration Department. They are key persons involved in the management development issues in the Ministry of Education and the central government in general.” (Note names taken out for confidentiality sake.)

Fifth mail: “Unfortunately I have to decline the interview. Mr XX is the right person to tell you about management development at our ministry. I have not any further information on the matter. Luckily you have managed to organize suitable time for interview with Mr XX. All the best for your research!”

Thinking that lack of clarity of the research plan could have generated this “failure to find link”, two colleagues reviewed it; and, it was clear to the point of finding how the management development reform has filtered the hierarchical ranks and affected performance in the Ministries. This was a critical moment and reflective point of the study judging from the management of the Ministry of Education’s failure to find how it related to them as it was put: “We unfortunately failed to find a specific link with your research plan to the educational and cultural government sector”. Clearly a problem exists, that is Vision 2012 does not exist there; a failure

to recognise and integrate Vision 2012 into the sector function. It is perceived as a lack of responsibility of the administrator and the human resource manager (Loveless and Bozeman 1983) and the line manager as well (Bratton and Gold 2003) as they are supposed to be partners (Schuler and Jackson 1996) in this process.

This may differentiate the Ministry's function from management development; which is, in fact, supposed to be infused and coordinated to with other development projects in government (MoF 2002; 38), to update their managerial leadership. Moreso, when the very human resource officer writes to concede to little knowledge of matter at stake; at the time when "we have emphasized this fact that personnel policy must be linked to management policy at several levels, at government level; also at the institutional level; and, so human resource management issues be integrated into general management procedures" (Interviewee 6). Yet this is not the case in reality. It, therefore, propped up pondering over how the Management of Education and its Human Resource have handled Vision 2012 to elude its beneficiaries at the Ministry and its sector, the management of the Ministries at large and the envisioned common culture came into sharp focus.

With this development, the new strategy in approach called for horizontal assessment and informal entry into the research area. The former meant contacting more ministries and strictly dealing with the very top to find out if Vision 2012 which is designed for them a decade earlier has indeed reached them at all; and, what they have done, and continuing to do with it. The informal entry was to contact people directly; and, interestingly, it worked out better and was, therefore, used throughout alongside the networks of interviewees while snowballing to related organizations and individuals (emeritus professor of presidential historian, former under-secretary of MoF, and a revered American Professor – one of the "three wise men" – conversant with Finnish Public Administration) for wholism; most intriguingly no any program champion or sponsor (Bryson 2004) was found besides the official owners. Patton (2002) would describe this process as following the story's own leads making it natural discovery unlike the experimental positivism manipulations; that would have treated this situation like objects for one final correct answer (Myers 2009). At this stage, a horizontal sweep was performed within the limited time and resource to ascertain how far Vision 2012 has been disseminated to its beneficiaries, the top level management. The Finance Ministry, Vision 2012 owners was contacted for financial support to enable a wider coverage but that failed.

Following this preamble, the process moves to look at the actions and inactions of Vision 2012 core formulators, and then to the Home of the Reform before the entirety. To the rest of the system they were left to their fate as Vision 2012 (MoF 2002; also at the Ministries web page) wrote and confirmed by interviewee 1, that, “it’s up to them”, the ministries to implement; clearly, a self-detachment statement from the reformers, a lead organization in the Finnish Public Administration. However, lead agency of the sort is qualitatively equipped and institutionally positioned to be responsible for the sustenance and development of administrative reform policy (Temmes and Sootla 2004; 2-3) and its implementation. The corresponding success for such an implementation model challenges the implementees to be strategically smarter than the reformers to pre-empt the reformers’ ideas as no further contact after its introduction (Brunssen and Olsen 1993).

2.1 Conclusion

Albeit a qualitative study, the necessary statistics are made and supported by prose revealing further detail that the table fails to do for better clarity. The nature of the analysis to come is walk the reader through the process with picturesque exemplified with quotations, paraphrasing and connecting to the literature, its concepts and theory for validity and reliability; as well, to reveal the evolving implementation style of Vision 12 and the direction of the study strategy. Respectively: 1. The “it’s up to them” model of implementation seems to be an expert and silo-slab system phenomenon picked up from the study and other related publications of the reformers (MoF 2002; 2003; 2008); as the expert knows all and what to. The exchanged emails or personal communications quoted above supports this model of implementation. It also hints of poor or no direct links of facilitation from policy owners as well as poor communication and dissemination of policy for implementation. Thus between and among the Ministries of Finance and Education there is no collective action, centralisation or culture of sharing Vision 2012 despite evidence of contacts. In all, it spells out the existence of tension intra and inter-ministries.

2. These initial circumstances deflected the original vertically or top-down filtration strategy to the substantive evolved horizontal investigation of the Ministerial apex. This makes sense, for after all, the Vision 2012 is more about the horizontal apex people. Truly, strategy is organic as Farjourn argues and evolves in implementation to confirm Hill and Hupe’s

observation, but from an existing one as of this study. With these initial evolvments what then is the whole empirical state unfolds in the next pages following what this study labels as the funnel shape analysis (FSA).

VII Qualitative Analysis and Findings

1.0 Introduction

This chapter of analysis for knowledge, meaning and understanding is sectioned into three; namely, the strategic formulators, the home and system-wide implementation of the Vision 2012. In this manner, the strategic formulators are quarantined to find out some of the shortcomings noticed in the policy formulation and design as well as how they understood and acted being the decision-makers of the Vision. It also depicts Dunsire's (1990) gap between input-intention as well as the output-outcomes gap. Having noticed the hostility of the reform home the Finance Ministry from chapter V, it is worthy to analyse it separately to uncover how it was all managed of the Vision. It was also noted from the chapter that reform literature demonstrate the source, ownership and home are catalyst for success.

These separate analyses would then move the meaning and understanding further into the system as a whole based on the study scope of Implementation Communication: understanding, willing, capability and culture. The revelations include management by objectives and commitment culminating with the theory tests. The determinants elements are **for policy relevance**; communication generally and specifically **Implementation Communication with its conduit material of implementation properties from 2002 to 2012**. Findings are heading the sub discussions with the whole sectional conclusions at the very bottom of the three main sections: 2; 3 & 4 whereas 5, tests the theories with the findings.

2.0 The Strategic Formulators of Vision 2012

Vision 2012 Working Group totalled up to 12 (MoF 2003): From the earlier analysis of the reform case chapter, they were found to be more of subjects not players and, far from context setters with interest out sizing the needed power to change things; but with a plan to buy political power. With half the number being the very core committee members the other provided the necessary support. Seven out of 9 contacted granted interviews. That is, 5 core and 2 support members. From the previous analysis it was clear Vision 2012 is an all civil servant creation. The composition of the group was questioned in relation to the basis of public management (Lynn 2003/5), its primacy and entrustment with national resources (Cole

and Parston 2006), governance – with implementation as a function (Peters 2004; Hill and Hupe 2002), management development (Drucker 2008), and leadership being an integral part of management and communityship (Mintzberg 2009). Above all, the private sector was supposed to be the laboratory for public sector reforms (Schedler 1997) and the decision principle is tagged isomorphic (Dingwall and Strangleman 2005). This is to fill up empirical and theoretical gaps revealed from the earlier analysis of the Vision 2012 issues as follows.

2.1 Finding: The policy lacked guiding theory

Government working papers are rarely scientific (Loveless and Bozeman 1983); but not for the lack of scientists. Recommendations from policy and implementation studies (Hill and Hupe 2002; Morgan 2006; Buzeman 2007) have advocated the adoption of both theory and empirical evidence in policy making at least for understanding purposes (Cockman et al. 1993; Morgan 2006). With the exception of the only researcher in the Vision 2012 formulator and design-group the rest argued it is not a scientific paper. It is for political consumption, they argued. Does this mean compromising quality and, perhaps, standards too? According to the lone researcher in the group: “we don’t, of course, have of any kind of management theory there [in Vision 2012]; that, I was interested to discuss at the start; and, if the Ministry of Finance had accepted some kind of management theory first of all; they said no”. Another explains, “We did not need any consultant” for that (Interviewee 7). “It was not a research in that sense”, recalled Interviewee 1.

But all indications of the group’s actions and processes put it as Action Research or case study (Patton 2002; Cresswell 2007; Marshall and Rossman 2006) which often deals with or by practitioners intending to improve their own situation to discover problems; and, solving them with partial external support. As Kuisma (1999) would have recorded the repeat of the traditional rejection of the expert’s advice, in this episode, on theory; despite being invited on that basis and the outright rejection of the consultant; despite being an expert system (OECD 2010). This is a cultural feature as ‘owners’ are not told what to do for they ‘know it all’.

There was neither any tangible justification for rejecting the proposal of the researcher nor for the political purposes or even the consultant. Quality and portability were compromised as a result. The usefulness of theory includes shortcutting; the need to store and remember the detailed masses of data on a phenomenon; importantly, a theory as an abstraction explains most of them (Mintzberg 1979; vi); with the predictive ability (Crowther and Lancaster

2009). Consequently, Government papers, for that matter, Vision 2012 and lost comprehension, guidance and focus of its value-model as its analysis depicts. These confirm arguments that reforms are mostly ideological and divisive based rather than tested theories and neutral management tool (Minogue 2001) and their performance management failed to be aligned (Reichard/PUMA 2002; Taylor 2001). **Theories improve policies and for better implementation. But in this process, the quality of Vision 2012 is compromised for traditional value of ownership over expertisation.**

2.2 Finding: Vision 2012 is monobased (civil servants), avoids its environment and disbanded

You were all civil servants who wrote the document? Yes, was the common affirmative response but differed in their explanations. The group failed to involve their political master, the private sector, the third sector and the governed. The Finnish Service Centre for Development Cooperation (KEPA), for instance, is the overall umbrella organisation representing the Third Sector civil society organisations (CSOs) working with development cooperation and other global affairs. KEPA's membership is estimated at 300 member organisations, ranging from small voluntary-based organisations to major national organisations funded with the governed tax by the Finnish Government through its Foreign Ministry (KEPA 2011).

As to why all that were not considered: Three (3) respondents cried it was strictly a public sector thing and for top civil servants. Interviewee 1's cry: "No, no, no; because we were just thinking what should be done in the public sector in order to improve the managerial skill and it is not at all big problem as it is among political world". To the contrary, the others admit it to be an omission. With two decades of private sector work experience, Interviewee 3 explained: "I only suppose that it can be somehow a mistake. I suppose it was partly my task to give this kind of information; and, also, to the project. Very good question says" Interviewee 2; "now, I see that we were only civil servants there... But the main part of the team was from state organizations so they were civil servants. It would be good thing if we would have some people from outside. Now, I see it. That is why it is a good question". The critical omission is the acknowledgement of not inviting and or connecting up to the politician and the citizens/opinion or community leaders. It was found that the formulation of the policy failed to include other critical sectors and the consent of the governed or its environment.

The strategic group is disbanded for good and never communicated on Vision: As pointed out in the paper analysis of chapter V, Vision 2012 document replaced the formulator leadership at implementation contrary to the advice of Bryson (2004). This strategic group is disbanded on completion of the strategic document. The Ministry of Finance/Government as an Employer, the owner of the reform becomes an 'arm-chair-implementer' as the "it's up to them" the ministries and agencies to do their own implementation. There was no evidence of the Ministry formally or informally contacting any of the strategists on their devised-strategy of implementation. These formulators were and are director-generals (1) and permanent secretaries (2) of the ministries as of now. One out of the seven interviewees is retired at the time of this study but contracted on the Vision implementation. S/he claims that the use of the document is relegated to the background as it has become kind of "background" knowledge with time.

Another response to the question of use or following the program is: "This is not so; I have not been any more after that group. Actually not; because we start; ok! But err... it doesn't give you much very concrete advice. I agree with every sentence but it doesn't give me much new from what I did before" (Interviewee 5). This is an example of the classic not understanding one's own reform (Bardach 1980). Very interesting to note is how one understood their own work and its function: "No [I don't use it]; because only me it concerns; because it is not concerning guys under me; and, I suppose I am also retired before this [became] relevant for me" (Interviewee 3).

Yet, the critical challenge may be found with understanding and commitment for implementation: Interviewee 5 prescribes the implementation facilitation role of the Ministry of Finance amid the difficulties such non-existent role becomes antagonistic elsewhere. The role: "I hope they make concrete action plan, how to implement this; and give us support, give us models, give us time tables what to do; I don't think people are against this but we are managing; we are also waiting what is happening" (Interviewee 5). The same any guideline from the Ministry of Finance question is strongly rebuffed: "No; it's not binding. It's not binding anymore" (Interviewee 7). "They are not committed to our programs"; one of the Government as Employer/Ministry of Finance interviewee responded. With this sort of relationships emanating from the core formulator/implementer, owners and their own work, thence a gap exists between the policy and the implementation spelling more on the 'it's up to them' implementation model. It challenges the operationalisation process (Dunsire 1990). How many of such policies are in the system as the study recounts a number of comments from interviewees such as "there are

such beautiful papers in government but they don't work" should be an issue of concern for the limited resources available. Nevertheless, these core group members are all said to be on some other "leading group" creating similar papers.

Two formulator interviewees were already on the new contract and fixed term assignments strategies of Vision 2012. Besides the owners/source providing any leading and facilitation roles despite the claim in a report (Turunen et al. 2006); reformers failing to understand their own work and no evidence of support requested from any formulator-implementee; raises questions of their very central core of their model: "will to lead and develop" backed by values (MoF 2003; 16) that they have violated. Trust reposed in this privileged group is out placed: **If the reformers themselves cannot understand and be committed to their own work then there is much to be desired in the system as far as reforming is concerned.**

2.3: Conclusion

Political consumption is misinterpreted and quality is compromised. Theories perfect policy for effective implementation. In this formulation and design process Theory based work is rejected by the traditional cultural feature of ownership despite being an expert based culture leaving the implementation process in limbo. In this phase of governance process the civil servant policy formulator designers excluded their environmental leadership needs and created a self-brand leadership to be imposed on the people. By and large there has been no action by these core group formulators/strategic planners although two of them claim to be on the new piloting fixed term contracts strategies. These pilotees are worried about what is the next move, especially, about their salaries and perquisite as they fail to understand the reform that they crafted.

Most importantly, these are the original reformers of Vision 2012 as they put the idea(s) together into the policy; turning round only to accept the wording; not understanding it; and, more importantly no action of implementation on their part. It puts the "idea" in jeopardy; and, a breach of the value trust put in them by their colleagues. For the last ten years the group has never met on the same subject any time anywhere again or communicated on it with the owners and or between themselves officially. Non commitment and lack of supervision and support of the formal setting might have, perhaps, led to the non-action. With

this privilege the formulators should have set the example by leadership rather than what looks more of betrayal of trust reposed in them. Having observed that it is pertinent to note the reformers should have taken a proactive role in initiating and facilitating the processes.

3.0 The Home of Vision 2012 Reform

As noted in the literature (chapter V) seven different components of departments form the Ministry of Finance, a giant silo containing subsilos. This growth in size and number for synergy has started with the Imperial Finnish Senate, in 1816 with two divisions of Judicial and Economic (housing civil administration). The respondents totalled 13 out of 18 contacted from the different sub-silos. Three of the 5 non-participants were from the “First” Minister’s side including the Minister, the Permanent Secretary and one director-general. The rest, to the other divide were the “Second” Minister and one senior director who turn the request down due to lack of knowledge of the subject. The Second Minister does deliver opening speeches to the future leaders program at HAUS.

The chief program implementer, a director-general was interviewed twice; one at the initial stages of the interviewing process; and, the other having collected enough data and needed verifications on certain emerged patterns with some running contradictory to the earlier told. For, instance, about half the interviewed in the Ministry did not have any idea of Vision 2012 policy and or its implementation, especially, those who were not director-generals or above at its inception; or worse, being outside of Helsinki at the time - 2002/3. Vision 2012 has spanned over Prime Minister Matti Vanhanen’s era: Vanhanen I (2003-2007) – Vanhanen II (2007-2010). The Prime Minister has never been heard comment publicly about this vision and leadership issues generally according to all respondents. No speech was traced from the office data base unlike in Singapore (Jones 2002) where such speeches abound among both bureaucrats and politicians for such a scheme.

3.1 Finding: Vision 2012 information is/was poorly dissemination and not understood

Indeed, the Permanent Secretary or State Secretary (preferred in Finnish Ministries) of the Ministry of Finance following persistent requests for an interview finally broke the silence by responded via a secretary. The following is the emailed correspondence with the name replaced: “... I reminded him again from your request to interview him. He answered like this (my translation): "Thank you for your request for an interview. However, due to the Ministry's internal division of duties, administrative management development matters are strictly the responsibility of Permanent Under-Secretary QQ. In my view I would not be able to contribute to the subject matter, as I do not possess detailed knowledge in this field. Regrettably, I must therefore refuse the request for an interview, but I am confident that

your interview with Permanent Under-Secretary QQ provided you with the best possible information available that the Ministry of Finance can offer. I wish you success with your thesis and an enjoyable summer."

Notice that from the comments instead of being directly responsible and practicing the knowledge things rather go the opposite way: "...administrative management... strictly the responsibility of... and I do not possess detailed knowledge in this field". While the first part deals with turf boundaries are well demarcated and protected (OECD 2009; 2010), that is, silos the later part speaks of the non-existence of the policy and its effects. Furthermore it depicts the behaviour of the Caiden (1994) bureaucratic excesses. These come from the supposed lead beneficiary and over all chief bureaucratic implementer, at least, of the Ministry. The emphasis here is more of practices rather than knowledge of fields. As the chief coordinator of the Ministry s/he should have been the centre of information, communicating and connecting all other parts and units together instead of talking specialisms (Mintzberg 2009; Dunsire 1990). Importantly, Vision 2012 is to equip and enhance such knowledge and skills of her/his and other expert managers as hybrid expert managers or better generalists/administrative class (Ferlie and Gerathy 2005; Caiden 1994). But this analysis notes s/he continues to do the specialist things; thus remaining in his/her comfort zone instead of the difficult necessary communication and coordination and flux of managing and leading (Mintzberg 2009).

This could be a partial failure of a responsibility of the big picture reminder to the busy people, a mission impossible: "But I think that one of my key roles in this ministry is to remind them that this is the big picture...; our top management we have three persons there: secretary of state and two under-Secretaries; mostly I think that I might be in quite good connection with the 3 persons; but of course our line managers also. And ... as I said, I should be but it is not always happening so constantly" (Interviewee 19). It is ridiculous to even talk of a job position of the sort: a manager reminder; for telling managers of their own big picture responsibilities. It is a case of failure of leadership and the centre would not hold glued due to pockets of power. It therefore points to structural problem, as the structure is the glue that binds organisational parts together via communication and coordination mechanisms (Mintzberg 1979).

"We had the strategy and my job was to implement" according to Interview 8 hereby labelled chief implementer. Continuing: "Well it will take many years to implement. And what's the reform? That is, well, it has background in the state overall personnel policy; so that when we will have less employees, less

workers in Finland in the future due to age structure. We thought that was key elements to attract young people and older people who have better management to come and work for government [This model is synonymous to the American SES model that recruited already well-established outstanding professional (Riggs 1994), contrary to developing their own managers proclaimed by Vision 2012]. We have been planning and planning and we try to implement it in 2006 by law; we made the proposal [bill] to the Parliament and it was kind of disaster because the Parliament didn't accept the proposal [bill]". To the chief's boss, the Permanent Under-Secretary of Administration the new government, Vanhanen II, with its pretty young ministers of the Ministry is doing well.

How is the leadership doing at the Ministry of Finance? "Well, the timing of this question is very excellent because this building is to be renovated after one year by a project code named Ministry of Finance Campus Project" says the Chief Implementer. Studies show type of building design affects behaviour (Pfeffer 1997). The chief explained it was but a modern design with great working atmosphere: "something friendlier compared to those closed doors; so we are discussing at this very moment what would be the leadership style in the Ministry of Finance in the future; of course, we had some word for it, and the question is how to do it; but we would have something empowering leadership styles; that is what we are doing in this department all the time. If we want to do that we have to go away from the hierarchical way of looking top down; managers have their responsibility but coaching and help other people to flower, flourish and so on; so we are in the process of doing that so everyone is, quite has the same feelings; and, one of the challenges is we have to find the same language with the economic policy department".

Has the Economic side being supportive in this process [asked in the second meeting with the chief having realised a divergent situation]? My section Minister is supportive but not the other exclaimed the chief. To the other, the Minister and the civil servants in the Budget Department the issue for them is how to make money, s/he added. "We have very strong departments here; for instance, we want to discuss with, our office department want to discuss with the Budget Department in terms of human resources issues within Government and how to have a common understanding is a big issue" (Interviewee 6). Such non-cooperative comments are not uncommon in the Ministry of Finance as the OECD (2010) points to that of the Budget's. In this present process it is found the so much talked about "Productivity Program", for instance, has nothing to do with the Budget Department; just as the "Governance Program" is only confined to the Public Management Department of the Ministry said to connect better to the Prime Minister's Office (OECD 2010). Absolutely, no turf threading seems to be the norm as observed from the permanent secretary's words. These little findings explain further the pockets of power within the Ministry creating the insular culture of **independent** [a borrowed

common word of all the ministry's interviewees and literature including Vision 2012 document] units.

Vision 2012 failed to be even a popular document with top executives in the Ministry of Finance. Asked if they have attended any training programs in connection with the Vision propped up names such as JUST – “Julkisen johtamisen strategia” (The strategy for public sector management; JOKO – “Johdon koulutus” (Management Training) and so on. These are programs conducted in series by HAUS for mainly middle management. Most interviewees remember taking one or two of those courses long before the birth of the Vision 2012. One latest arrival from the north via posting has no clue to these happenings including the Vision under study; thereby suggesting all is in Helsinki and perhaps its immediate surroundings and far from the entire country coverage. The case of another director-general within Helsinki but outside the Ministry itself before 2005 does not remember anything about the Vision. S/he remembers very well taking one of the JUST courses earlier and criticises it as too general: “It doesn't get the real substance, of course, not enough will you get” (Interviewee 17). This challenges the subordinate (individual and institution) the right to decision rule (Dunsire 1990) and system-wide communication.

A per chance, information on the policy got to this top middle level officer – aspiring director-general: “But the thing is that this reform is not our everyday business; it is something which I have heard from the side[line]; I have no direct connection to it. First, from the Prime Minister's Office and later while at HAUS taking a course JUST; Mrs AA (the chair of the group) came to talk to us - about Vision 2012. I got a feeling that HAUS somehow tried to, at least, they tried to advertise the training program and somehow they wanted to link the course or training program to this reform; but I haven't been in any real training which has been connected to the reform” (Interviewee 15). This comment demonstrates no really training program existed but preparation towards that. That was an observed trend and it re-emphasises Vision 2012 is poorly advertised and communicated to its unknown beneficiaries and community. It also raises the question who is the true future leaders`?

3.2 Finding: Poor management of the informal and no leadership by example

Rivalry, Conflicts, Egotism, among others prevented leadership by example using Vision 2012. After a couple of email exchanges a 16-minute telephone interview was achieved with interviewee 18. S/he is very aware of the study document and ordered it to be

mailed to me as a replacement of the interview earlier on. S/he claims to also have contributed to its development but when it comes to its daily implementation his response is: “well, not in that sense that it would be used regularly”. How is the occasional practice done was the follow up question.

Within the very first split of a minute the interviewee had demarcated the fault lines already: S/he has indicated that the interview was with the wrong person and a waste of time; “... therefore, it was, I mean you speaking about things that are not under my responsibility, under my sort of conversation, I mean really its wasting your time; I mean speaking about public management issues. Sorry I need to make a phone call by right away and I mean please talk to Mister CC or his senior again; I really feel that I am not the best person to give your replies; bye!!” (Interviewee 18). The telephone line went dead but did not deny the facts of tension and emotions right from the start through to the end of the 16 minutes.

Perhaps the relationship between the two Permanent Under-Secretaries in the tall Ministry is what Sennett (2008) may describes as ‘invidious and obsession’. Recounting, there was instant mood change when the question was posed to the other colleague concerning the Finnish phenomenon pros of synergy construction by way of collaboration, particularly, leadership by example (Halligan 2005) between the two Under-Secretaries using Vision 2012. As a colleague, have you ever sat down to talk something on these reforms, management development plan? “Why are you asking this? Have you been asking ...? No!” I hope to talk to him too. “He is doing something different that is why I am asking. Ok! He is doing something different than I am doing; He’s doing economic policy; so his angle is a little different than mine; I have more; I think I take the hard burden, heavy burden on my shoulders.”

Continuing, s/he notes: “Well, we meet every week so I think this is more or less daily coaching; he is very aware of the challenges because he is responsible for the creating new economic policy in this recession; and, also, he knows the shortage of labour; and he knows also that what are the big challenges of the public sector; so in a way he knows the drivers and what we are discussing are the means, how to do it; he does it in his way; and, I do it in my way”. Good! That is why I asked this question: “my way”, “his way”. Is this not what is killing the reform? But “our way” is what may promote the reform; what do you think? “Now I don’t really understand your question”. Having further explained things to mean collaboration or joint effort by way of integrating and adaptation of Vision s/he bounced back: “But then I understood you a little incorrect; because I understood that what is a good thing is, of course, that we are as persons and different as leaders; we have different styles and so on; in a way being a good leader

you have to put your personality in this leadership otherwise it doesn't work; you see it is very clinical or something like that".

The explanation also entailed the question was to elicit leadership by example based on being equal in rank and in the same Ministry and for emulation by others. "But, of course, what makes it a little bit difficult is, of course, they are a lack with time; and, that means he is working on different parts of the EU or whatever; so he is doing very much the foreign economic policy as well; and, I am doing the internal; so that is the problem we face, especially, now when it is very hectic – the recession and what is happening or should happen in the world". Note that these justifications fail to stand the Under-Secretary's tests as even within the Administrative section people are doing different things and constrained with time yet s/he is supposed to be managing them. These excuses and comments from both sides do not add up particularly for a management reformer. Rather they explained more on behaviour and attitudes that have resulted as a failure of proper social pressure management (Selznik 1957; Glombiewski 1983), management incompetence (Peter 1966; 2011) and structural problem with no supervision (Mohr 1982; Mintzberg 1979). As noticed earlier the manager reminder's failure at work had led to conflict at the apex of the ministry. Vision 2012 is saddled with poor communication, lack of clarity and inaction at the very home and owners.

3.3 Finding: No managerial leader and coordination at the Ministry of Finance

What would you suggest for the future of our civil service leadership development? This was another question put to all interviewees of the study. The Ministry of Finance's picturesque may well be illustrated by the response of Interviewee 16. To keep its pristine beauty and relevance it runs verbatim with interspersed summary deductions as follows: "Well, I mean, I think what needs to be done is really to make sure that the usual stuff, you know, be rather clear about what the goals are. Get leaders who want to do stuff rather than be stuff [Suggests the leadership is the problem?]. They take those leaders who really don't want to be leaders and put them in charge [corroborated by Interviewee 10 also of the ministry]. Make sure that there is discussion within the units and within the departments; and, make sure that whoever is leading whatever unit or department or whatever has an idea of what their jobs will affect [effective communication needed]. Because **the most difficult thing I found is to assess how different things interact and that is the most difficult thing for me to teach my people and even to teach myself.**"

"So you really should have experts who would, are able to think like unit leaders; unit leaders who are able to think like department heads; and department heads that really think from the whole ministry's point of view [broad view leading all levels]. And make sure that the main thing that they have to produce is results not

reports [performance]. I don't know anything else. I mean the problem for me is that I don't have a general philosophy except that to try to get people together and make sure that they know what they are supposed to do (that is your philosophy; getting people together and making goal clear). Ok! Alright, ok may be. I mean that I think it's one of the problems in the ministry as well. People might get together in the departments but not always tighter [bound by formality]. They, certainly, there is nothing there is nobody gathering people together in the ministry [lack of coordinator]. I mean it's a ministry consisting of departments [Independent functions]. It doesn't exist in itself in a way [having the real power]. That's chaos or dangerous I don't know [pockets of power and rivalry]. It is something I never expected when I came here. I thought the ministry was rather clearer. That isn't."

"If I am exaggerating I don't have bosses [structural and supervision problem]. I don't have I mean. They are out there somewhere doing their own stuff. So, I have to manage on my own which, also, of course, as I said before it's not a bad thing because then, I can do the things I like [Independence culture and personal values and interest rather than that of public/government]. But certainly at the time when I then need help, you know, my boss doesn't have a clue [lack of leadership]. What have you been doing this for 2 years? What! ... And, of course, I mean I could report but you know they don't have time and inclination to take part in the planning afterwards; and they don't realize anything that it implies [lack of knowledge of happenings and not concerned]. And, all of a sudden I come there and say, hey, look because you said this here now you have to do this which you don't want to do and now you get into all kinds of problems."

"So, I really think it will be important to have somebody in the ministry interesting himself or herself only for the substance of the ministry [managerial leader defining...]. Only doing what nobody else does; trying to gather all the issues and looking at how they fit together and how they should sort of fit together better [defines managerial leader job]. Nobody is doing that. It's done every 4 years in the government program but that is not enough. So, but that is not leadership stuff but in a way I guess it is. You have to do what nobody does that is making sure that your subordinates have a boss or somebody they can talk to. And somebody who helps steer them find their way until everybody goes more or less in the same direction. And I know that they are doing that on their own; I try to do it on my own [self-management] but nobody else, nobody above me is doing it [managing independence]; it is difficult I understand it very well because I mean I would really, really like to do real work for a change, you know... But Leadership is really making sure that others get to do their stuff not doing it alone [collective commitment of the OECD; and central and common shared culture of Vision 2012]. And, there, I think there is much to do in the ministry. I don't know about Finnish but certainly a lot of places that I have gone have the same kind problems".

The laced deduction alongside the story makes more meaning and clarity of the independence and fragmentary nature of the Ministry of Finance without managerial leader(ship). On her/his part, Interviewee 17, another substance leader notes "we have easy access to the boardrooms when problems come. But I have, I must say I am a little bit critical of the top management of the ministries so that they, perhaps, have too much of their hands off it". ..."but, of course, there are other problems of

organisations because traditionally, departments have been very strong and very autonomous too; so that this is a kind of problem of general information. And, I think, to be frank it also comes from the kinds of leaders attitudes of highest level of leadership of Ministry of Finance". These most critical observations have come from the so-called uncooperative substance people (Interviewee 10, 16 & 17). It leads to the questioning of the lead agency (Teemes 2004) and its coordination roles (OECD 2010; MoF 2002), information, communication and leader(ship).

3.4 Conclusion

This ministerial analysis although not an isolated case, demonstrates the continuation of the non-communication and non-action on Vision 2012 from the strategic formulator-group. That trend also reveals and re-emphasises Vision 2012 is poorly advertised and its true beneficiaries are unknown for they seem to be targeting the very top people as the document described. And no evidence of any new training emanating from the Vision has reached them formally or informally. Attitudes and behaviours that have resulted as a failure of proper social pressure management, management incompetence and structural problem with no supervision are thought to abound and uncaptured. Managerial responsibilities are shirked for specialisms. The consequences involve fragmentation and insular culture, passivity and poor conflict management at the apex of the ministry or packaged into horizontality problems.

Vision 2012 is saddled with no voice and poorly communicated and inaction at it very home. Home, ownership and source contrary to literature expectation of better implementation fail to be that catalytic of synergy and success. Furthermore these interactions may explain the pros and cons of the OECD Finnish phenomenon encountered in chapter IV. These most critical observations have been the definition of managerial leader job and how to lead people for results with requisite values and effective communication. The ministry has no managerial leader at its centre leading a coordinating its functions, people and activities. This makes it impossible not to question the suppose lead roles of the leader(ship) and the ministry and the relationship with the rest of the system.

4.0. Vision 2012 System-wide Implementation Communication

The deficit, Dunsire's (1990) two-gaps of the input and output against intension of Vision 2012 has been identified with both the formulators and the Ministry of Finance; its failure of implementation communication to grasp attention and action; and, even leading to the exposure of the ministerial structural, organisational and managerial leadership interface problems due to specialisms and others in competencies of horizontality (Peters 2006; MoF 2002). The process of looking at the implementation and output process continue but this time putting the wrap on all 37 interviewees from 9 out of 12 ministries; Parliament and the Presidency among other institutions and network of implementers. It makes a fair representation of the Finnish Public Administration. This provides a broader and attempt at wholistic view of the Vision 2012 implementation.

From Finding 2 and 3 although much as it was observed to be not any more binding it was equally not forthcoming in any form such as instructions or facilitation or leading role and or communicating Vision 2012. No action on policy implementers has been the result. The relevance of the issue of obedience (Hood 1976 in Younis and Davidson) and resource provision and specificity of instruction raised in the theory of implementation becomes apparent (Mountjoy and O'Toole 1979) cite Younis and Davidson (1990). The analysis so far defies this theory's four interpretive grid that: 1. new resources with vague instructions fail to acquire management/policy maker's view; 2. new resources with specific instructions makes straight understanding for implementation; 3. no resources and vague instructions possible generation of voluntary and expected actions; and, 4. no resources and specific instructions produces least direction of all.

The issue here is not lack of resources – the Parliamentary Committee on Administration Focus Group interview remembers never received any request or issued resources specifically for Vision 2012 processes – but no instructions and no communication plan. That generates from no action to anything possible. An example is the reformers establishment of the strategic proposal 6 coordination unit at the Ministry of Finance expected by 2004 (MoF 2003; 32-8); still does not exist at time of writing. The lack of ideas has been cited. Reform capability including information generation and communication, and commitment come to

the fore (Loveless and Bozeman 1983). Consequently, the study scope Implementation Communication properties are investigated as follows below.

4. 1 Finding: Poor Communication for Understanding of Vision 2012

Earlier, during the data collection the chief implementer was met twice 6 months interval when the data pre-suggested what was told from her/him run contradictory to what the field was revealing. Following these revelation, an email of enquiring of any retreat(s) by chief implementer and her/his team was fired to the chief and no reply despite the promise of cooperation from the both meetings. The chief, him/herself has indicated s/he was brought in to administer the processes after its formulation (see Finding 3.1, pp.144) making it more pertinent for this enquiry. Also, subsequent emails to remind of the promise to interview his/her program consultants and chief adviser yielded no response.

Furthermore, there was also no evidence of contacting the formulators to discuss the document after its conclusion albeit engineering it all remotely. Speculatively, the chief and his entourage have never reflected critically on Vision 2012 for understanding, capacity building, value-will to lead as well as the cultural hindrances or promoters despite his/her claim of “taking too much time in the board room”. There is no theoretical guidance (Finding 1). All appears to have been taken for granted thereby raising questions on the original ideas of the Vision 2012 creating suspicion about the, operationalisation process for implementation (Dunsire 1990). Understanding even one’s own work requires reflections. For example, while interviewees 2 and 6 both formulating member disagree on the career and non-career issue; interviewee 3 does not use the document because s/he understands that it “No, because only me it concerns; because it is not concerning guys under me; and, I suppose I am also retired before this is relevant for me”. Bardach’s (1980) classic of the reformer fails to understand own reforms and therefore never communicated her/his own policy to others seems relevant today.

Also noted already, the strategic group was disbanded after their work and never used or contacted on the policy for any part of the implementation process. The partial exception is HAUS, another lead agency which is used as a tool for the Future Leaders Program. It is noted that all (5) interviewed below director-general rank before 2009 got to learn of Vision 2012 at HAUS training grounds. One of such newly promoted director-general recollected:

“In fact I was attending strategic management course in HAUS some 5 years ago, JUST 5, and, the chair of this working group permanent secretary AA gave a presentation and so I got familiar with that report as it was quite new”; the principles are familiar to me but I don’t use it at for my daily purposes (Interviewee 28). It has been the only occasion ever while describing him/herself and the newly appointed permanent secretary of another Ministry as “guinea pigs for the piloting” (while displaying and explaining his new contract). S/he is tensed as s/he doesn’t “know what they [Ministry of Finance] mean by that proposal”.

Interviewee 28 like the others did not hear anything of Vision 2012 from his/her bosses and is not sure if they knew something about that. Interviewee 15 had information in 2006 on the Vision informally when s/he worked in the Prime Minister’s Office when it was at Cabinet but not from her/his bosses or formally; and, of course, at HAUS. Interviewee 27 and 30 learnt from friends; and, others too. Personal networks have been useful to others and to this study as well. One such relevance occurred when Interviewee 27 got to know of all these happenings only in 2009 at HAUS while attending a program. On contacting her/his other colleague in her/his former Ministry as to why they were not at HAUS for the program s/he replied they were not aware of something of the sort. So, bosses do not seem to flow information down the hierarchy; but keeping things to themselves and may only inform their favourites. Or, they are simply dumped in the internet and intranet with little or no direct verbal communications and presume information [is] shared (Interviewee 8) and understood. HAUS is found to be the mouth piece of Vision 2012.

From the accounts of Interviewee 6, together with the chief implementer, they have been into the ministries to meet and communicate the gospel of Vision 2012 to top level managers when it all begun in 2002. Its rejection and resistance led to article postings in the media. Yet, information on it remains scanty even at the top as noted already at the reform home. While in the same Ministry Interviewee 22 found it strange to locate off his office bookshelf Vision 2012 document; Interviewee 24 on his part was very aware of it and even claimed contribution although he talked of its ambiguity and lack of understanding. However, both do not apply it in their daily work as expected or their consultants. Both have been over a decade at that director-general position. Some were not sure about it as such government papers are all over the place say Interviewee 26 and 11. A management and leadership development trainer Professor Pauli Juuti of Johtamistaidon Opisto JTO/ JTO-Palvelut Oy, remembers very well having been interviewed for the Vision; but has never again heard or seen the

output till this interview day. While others remember something like that faintly others too are totally ignorant about it, for example, Interviewee 9.

The political top is in the known of Vision 2012 the document and its implementation – at Cabinet (Interviewee 15), the 2006 failed bill and the so-called “critical comments” of the ex-Minister (pp. 131) of the policy especially of the pooling of managers (Interviewee 1, 8, 15, 24, Parliamentary Committee on Public Administration FGI, etc.). But what is not obvious is how politics is promoting or thwarting this implementation process. No permanent secretary or director-general interviewee remembers receiving minutes about Vision 2012 from his/her minister. There is a vertical communication gap there at the very first tier. The Parliament, Presidency and Ministers roles are assessed further for evidence of Vision 2012 in this implementation communication process.

The Parliament: The Parliamentary Committee on Public Administration is aware of Vision 2012; and has interacted with the Permanent Under-Secretary for Public Administration on it in 2003, long before the failed bill in 2007. Its principles are consistent with their thinking they claimed in the Focus Group Interview (FGI). However, no official handling or comment whatsoever has been made on it from the floor of Parliament and its leadership; or any particular resource issued to that effect. A search through their speeches and asking from interviewees makes confirmation. The Secretariat responded: “I think that they don’t have spoken about that specific report. Certainly they must have spoken of those ideas, but we don’t know about their speeches. There is nowhere that kind of information”.

It was in 2001 when the Committee interacted with the best expert on this paper. Although not officially handled Vision 2012 issues are familiar: “the ideas are not new; they have them in Finnish society already a long time ago and the Committee has emphasise them before so the report itself didn’t change anything. But it just put the things in a frame and into the words and, of course, it has been a decision to them to be implemented”. The FGI argues that traditionally, the Finnish civil service chiefs have been “more experts than managers or leaders. Expertise has been more important. But nowadays management and leadership is coming more and more important. ...We have had in a way experts in leadership of departments. But, so that you have been chosen to be leaders when you have known very well the expertise of the department; and, then perhaps, you didn’t have the leadership to lead the other people. And that has been, I think, under discussion in the Finnish Governing System about 10 to 15 years”. The group distinguishes experts from managerial leaders as well as the public and civil service’s long overdue need.

This management and leadership conception is a dramatic irony on issues of structure and roles: 1. Respectively, in the structural review (chapter V) it was not easy to establish and understand the leadership of the Parliament and again turning to the secretariat brought up this: “Would I be correct to say that the Speaker of Parliament is the Leader there in Parliament, supported by the 2 deputy speakers as it is not clearly stated at the website? Yes, I think you can say so in general level. As a matter of fact it’s more complicated question if we speak about details. That’s why websites are not so clear”.

2. What have you done since the launch of Vision 2012 in 2002 yielded such FGI responses as: “Here in Parliament? No not in the Committee. As they [Vision 2012 owners and formulators] told you the Committee has no roles; has not taken any roles. No roles for that. [But could have taken?] Yes, we could have. The position in Finland about this leading is not that kind of; we don’t do that; that leading that way; that the Committee is going to take leadership role in the Finnish system; but if there would be some problems we could take it up from the table. It is not so that all time that the Parliament by itself will take something on the table. So this has not been. We don’t take part at all about leading. And usually Parliament doesn’t mix into the work of government to tell its opinions” The FGI argues Parliament considers bills and government statements while conceding power to the Government – Executive, Ministers and top civil servants – whose responsibility it is to lead and govern. By this analysis Parliament and its Committee on Public Administration are self-excluded from the national leadership. Vision 2012 also failed to apportion them any role in both the formulation and implementation process supporting the aloofness.

The Presidency: Neither the President of the Republic – the Constitutional mandated appointer of top civil and public servants – (2000-2012) nor the Prime Minister (2003-2009), the then head of Government had been heard of any comment of Government Management Development. Interviewing Professor Teemes confirms and explains this top-political inaction in a response to the question: Have you ever heard of the president and the Prime Minister give any speech on this leadership development? “I have been very long in this job; and, I have only once seen president speak of these issues. In fact, the first department chief but it’s already history in the Ministry of Finance; they call it department of public management today. The first department chief was Kekkonen, in 1944. He was one year. And, he has also written some articles of these issues [unable to access due to poor Finnish Language skill of researcher]. As those times they are called “Rationalization” and that is why Mr Kekkonen is our guru. We never criticised him. [I heard so.] That is the reason”.

“But the only occasion I have seen president speak was year [19]82; perhaps it’s President Koivisto who came after Kekkonen. I know the reason. He has a permanent secretary in the office of president who had this kind of background; and, he organized that. May be, it was so that after this very long period of Kekkonen there was

really need to reorganize and re-evaluate our civil service or at least some reforms. And President Koivisto had this speech in Parliament. They always have this beginning, opening speech in Parliament and he included quite long text on administrative reforms in that. But on the other hand, I know that quite many of our Prime Ministers have these kinds of knowledge and skills but it's not normal everyday politics at all. They are very careful speaking of this because **it is a very sensitive thing many many times.**"

"In fact in every government we have one Minister who is specialized in that government second minister in the Ministry of Finance. And there is a long role of these kinds of ministers. During Koivisto's presidential period it was old Minister Rekkola who was real hard expert in this. In fact we have in government some persons who are specialized or had responsibility for this; and, not so that persons had also according to skills and expertise in this area. But what are their real impacts and positions could be? They didn't want to have strong civil service. It is very understandable"; Teemes concluded. Efforts to speak with an Emeritus Professor of Finnish Presidential History from Turku and another professor of Tampere University failed. A third effort from the Ministry of Finance on the history of Finnish public administration also did not workout. Lack of knowledge on Vision 2012 policy instrument was sighted as basis for refusal.

This long chronicling reveals the culture historic effect of the top level political and civil servants structural relationship in Finnish Public Administration that are invisible today although not so long ago. From Teemes' accounts above, one can find the bond between the politics-administration leadership strong synonymous to historical accounts between the Crown and civil ministers in building central administration and the first modern states (Argyle 1994). Perhaps, the early elites promoted the Finnish public values (Selnick 1957; Bozeman 2007); thus by practicing Morstein's (1959 in Lynn 2003) blending the political and administrative thinking into a joint process; or into Redford's 'adjustive activity' to signify public management is the continuation of the political process of adjusting public interests (Redford 1969 in Lynn 2003).

Such necessary value aspects of organizations are suppressed or negated by conventional assumptions about organizational designs (Morgan 2006); more so, as Teemes found leadership issues are sensitive; as such would not be discussed openly for any understanding. Perhaps, making speculation possible as to why the Finnish Literature Foundation lacks material on Finnish conception of leadership or the subject not considered within their research priority scope: **"Did I understand right that you are interested in books dealing with the**

concept of Finnish leader and leadership? Unfortunately SKS hasn't published any books about that subject” the email exchange reported.

Although it is clear from Section 126 of the Finnish Constitution requires of the President of the Republic to appoint permanent secretaries to the Ministries and to her own Office, the Presidency today, for example, lacks a Permanent Secretary but has a Major-Domo, a nomenclature that is undefined and, different from all others. It is so because, the occupant does not part take in any of the top rank civil service activities by permanent secretaries and director-generals in the Ministries and the like despite being a senior civil servant. As pointed out in chapter IV on the Finnish Public Administration Structure, it was established that this major-domo reported to a director-general, a non-elected officer but a presidential staffer. This contradicts both the Constitution and practice of the past as Teemes recounted of the President's Office. The ultimate presidential performance in there is negatively affected. This arrangement weakens the Presidency generally as well as degrades the top civil service position; and, at the same time disconnects from the rest of the system. The major domo is far from the elected president to be served and supported as the appointed secretary-general stands between them; and, crucial information necessary to keep the President on the track of Constitutional Act 58 Decision of the President is hampered.

As it turned up to be, Vision 2012 and its associate bounced Bill never got to the Major-Domo officially. Thus through the president or the director-general the present official channel but by own informal networks. This ranking distortion of the civil servants was also seen in the Prime Minister's Office. It is a Permanent Under-Secretary who also reports to a political appointee and not directly to the Prime Minister. This political appointee [who might have no civil service knowledge and experience] chairs the permanent secretaries' monthly meetings; from which no issues of continuity of organisational and civil service issues could be found: a Finnish Civil Service Knowledge Repository. The lack of such Administrative facility and such handling of the issues lead to downgrade and distortion or loss of necessary knowledge and information right at the very top. For example, the over 50 year-old existence of the bimonthly Director-General meetings was observed to feeds into nothing as there exist no repository for that. The two top groupings meeting agendas have no correlation as they act and exist independently.

These two arrangements contradicts the rest of the Ministerial model where the top most civil servant, the permanent secretaries report to the elected Ministers directly in line with the Constitution. As a result, the President's Office is separated both vertically and horizontally from the rest of the civil service. Technically and by rank, the two top most offices in the country are weak from all angles including power relations particularly, being silo-slabs. Promotions had been based on seniority and long service rather than performance in the Weberian bureaucracy (Brown 2008). From the Vaasa University episode hierarchy mattered in Finnish Society with its communication gap. The ministries had escaped structural reform (Tiihonen 2001; OECD 2009), yet Teemes' structure described above has changed from what has just been described as the present structural artefact (Mohr 1982) all due to ubiquitous interests, and fear of competent civil service as Teemes and other interviewees observed at the state's developmental expense.

The Ministers: It was found out that no minister communicates on Vision 2012 to their subordinate top civil servants. This suggested that the substantive Second Ministers failed to take the Vision to their political colleagues horizontally; despite the support of the 2 young ministers – 2007 to 2010 – (Interviewee 14). Horizontality, (Peters 2006; OECD 2009; MoF 2002) the management for cohesion of government machinery has failed to materialise in this process. Going by Schein's (2004) observation that to assess leaders keep an eye on what they pay attention to, suggest Manager/leadership development is not the Finnish Government's priority. Dr. Johanni Kivela, the former Permanent Under-Secretary for Administrative issues confirms this assertion in an interview. Ironically, 'leadership' is the game sought for and played at the ministerial apex but silently.

No evidence existed to show that new managerial or political leaders and oriented with Vision 2012. For example, from Vanhanen I to II transition; new ministers or civil servants are introduced at any point in time with any part of the Vision when they are promoted or appointed higher up to the top level. Change at the top has itself been minimal as majority interviewed were already at their posts at the time of inception of the Vision 2012. Yet, it has failed to be popular and filter downwards and horizontally among the target corps of the Finnish politico-administration even in Helsinki, let alone, to other parts of Finland. As it is clear the simple information never flowed to be shared (Morgan 2006; Schein 2004); little is, therefore, left to be talked about let alone to be understood, a property of implementation. The owners themselves seemed not to understand their own policy. "[I]f I remember correctly, the

part of the criticisms of the original idea was perhaps misunderstanding” (Interviewee 15) about the controversial pool of managers for government (MoF 2003). To this point it is clear that the Dunsire’s operationalisation of the implementation would be and has been problematic due to lack of communication plan and discrete communication amidst structural difficulties and lack of interest.

The communication strategy is to blame at this point although most interviewees said it was normal except the chief implementer and her/his boss. The chief just as others was confronted with the question: how easy is it to share information in your organizations as that is one of the things of reforms? “Yes, yes; well, it’s a constant problem; whenever you make **a survey at working place on what is going on information sharing is not; maybe we are too technical in that sense; we put things on internet and intranet especially, and say that that has been informed; that is not information, it’s something else** or so; for example in our little organization here, what we are trying to do is we meet with the whole staff regularly every month and discuss seriously actual questions and in a way that everyone takes part, everyone has a say; and we have learnt previously that everyone didn’t take the floor; it was common that someone always the same person saying the same things; but when I lead this and other people we expected that everyone takes the floor; that is I think information sharing”.

Managers depended on reports from their immediate span of control; albeit such reports are viewed as old information (Yukl 2010) to know about their organisations. Direct subordinates are the best beneficiaries of the manager’s fresh information in the Finnish system. Perhaps, it is the nature of silo and expert systems. All top managers interviewed complained of time constraint for direct discussions with the entire department, let alone the rest of the sector. This brings to fore the challenge to Hood’s (1976) perfect administration model where communication and coordination is a necessary principle. One puts it this way: “I, sometimes I discuss with them **if they want** but some don’t; so then I hear something from the unit leaders but perhaps I don’t; **if there is a big problem then I hear it**; [so you depend on the unit leaders to know what is going on? This is the common practice observed] Yes; so I know I have the best knowledge of what happens on the ministerial level, and the government level, and the budget, and the big things; **but I don’t have the first knowledge of what’s going on in the department**” (Interviewee 24). S/he has not been able to visit all sites of his sector although haven been over a decade on the director-general grade. Distance was the common sighting as an excuse (example Interviewee 1 & 24).

From Hood’s perfect administration and its communication (Younis and Davidson 1990); to the manager’s job being the nerve centre of information (Mintzberg 2009); as an effective

and willing communicator (Hackman and Johnson 2009; Pfeffer 1997; Herbamas 1984); still there is the challenge of communication although most interviewees are aware and talked about the silo and horizontality (OECD 2009; 2010; Peters 2006). It was identified in the literature that the Vision document realised learning, innovation, teamwork and use of networks were the way forward (MoF 2003). The reformers lack the understanding of communication in their own system for the reform. A critical thing of the bureaucratic excessiveness that undermines is that junior rank civil servants are responsible of what government decides based on their bit of work: “the matter in government agenda is that when your name is mentioned you are legally responsible for what government decides not your position or boss”. Interviewee 15 calls “it very strange idea as it is abolished short time ago by the EU”. This could mean a subordinate/junior expert’s work is not vetted by his or her boss although it was the superior who issued or passed the instructions/order.

In addition, this could be a loss of experience from the boss as well as his/her common sense knowledge; or even failure of duty to ensure what passes through him/her is appropriate or not on return. The act also undermines authority of the superior’s responsibility for the command structure and challenges the right of decision rule (Dunsire 1990). What is not clear is if this has something to do with Act 118 of the Finnish Constitution on Official Accountability where officers are held accountable for what they have and been part of creating. If it is then it is a practice of bureaucratic excesses and NPM used to fragment the system.

All these undermine Habermas’ (1984; 2008) communicative action and face-to-face discursive quality; and, the Branson (2008) Virgin brand of management of any organization face to face contacts and the attention to details that really defines great business delivery. Therefore, need be to set deliberate, debating and participating in the future desirable change issues (Pollitt and Bouckaert 2004) with the target group (Vedung 2002); and decision makers; permits the ability to see the different phenomena constituting the coherent whole as well as revealing the very fundamental patterns, shapes and models (Morgan 2006). Vision 2012 fails to go through these processes of defining understanding and communicating the basics for reform implementation: In spite of the rareness of both political and bureaucratic communications and support, not even by its owners, somehow, top manager fixed term contract piloting is underway amidst tension while still leaving the question of the target group unanswered and nothing understood.

4.2 Finding: No new top managerial capabilities from Vision 2012 were developed

In the third chapter it was established that this study is the institutional approach based (Rhodes 1997; Brunssen and Olsen 1993). The Vision under study is/was to make managers mainly via training based on some stated competencies (see Figure 6 pp. 95). The study therefore views Vision 2012 as an institutional development tool having both instrumental and intrinsic values. Instrumentally, it is concerned with the evolution, aims and capabilities, of what Selznick (1957) calls the institutional leader. Primarily, Selznick describes that as an expert and a duty of the elites in the promotion, protection and preservation of values of a country. For, we are made of values (Blair 2010). In this section the institutional leaders' curriculum development and training/educating is looked at based on the communication practices and structure involving the reformers or change agents, in spite of having observed much on institutional level already.

One novelty left for the public sector from the NPM reforms is the introduction of performance management and its Appraisals (Brown 2008; Gold 2003; Taylor 2001). Unfortunately, these are observed to be poorly managed in Government and resisted by bureaucrats (Gold 2003; Reichard/PUMA 2002). Appraisals are thought to bring up both strengths and weakness of the individual worker redressing and further improvement. However, notwithstanding its 'famous' performance management program the Permanent Under-Secretary replied: "No"; to the question views as the starting point of the change process: Have you attached this Management Development Program to Appraisals? But interviewees revealed they had completed a *360 degree appraisal* form suggesting so many things are on-going but lacked coherence and meaning (Fashion and fad sake?). As to how this Vision's performance is to be assessed remains a hanging issue, therefore. Yet, the document argues moving from one job to another but challenging will be performance based and firing is the outcome of non-performance (MoF 2003; 25-6): "Implementation of the contract is followed up and contracts are reviewed in annual performance appraisals". It is neglected in this case. And, therefore, much remains to be desired as to how performance is judged and a move onto the next job at end of already tensed piloting contract tenure.

No evidence was available to show that Vision 2012 has been used to organize any training/educating for the top corps as none interviewed including the pilotees remember anything of the sort. However, both the ministerial and Parliamentary FGI interviewees

agreed to the importance and need for management development and education although with some reservations about the need for **substance**. Enough slighting evidence exist in the system towards the “non-substance” generalist or administrative class. It was noted that all of the permanent secretaries, permanent under-secretaries and most of the director-generals irrespective of their expertise had taken courses in management/leadership, either on their own and/or provided by their organizations (Drucker 2008). Courses taken included MBAs (not leadership anyway - Mintzberg 2004; 2009; Pollitt 2003) offered by private institutions, consultants and, of course, HAUS. These were taken between the 1980s and 1990s and they no longer as of time constraint and other factors attend such courses. Such courses are for the young some argued. Not surprising longevity at the apex hampers reforms developments (OECD 2010), for lack of continuous learning (Yukl 2010; Hackman and Johnson 2009).

All immediately below director-general grade – as the recently promoted director-generals – interviewed (3) learnt about the Vision while at HAUS (for top middle level management training). HAUS’ mouth piecing of the Finnish Government Management Development seems strong. One interviewee (28) on a seminar there noted the output of Vision 2012 discussed on the new government’s position as: “we were informed this would be the policy of the Ministry of Finance and if we are going to proceed to the top level position we have to observe these principles”. At least, one recently appointed director-general believes his appointment was partly based on being part of the Future Leaders Program (FLP), Vision 2012 deviated and dangles between the Ministry of Finance/Government as Employer and HAUS the service provider.

From Finding 2.2 above, it was found that against the definition of reform being participative activity (Pollitt and Bouckaert 2004) and even the JUG/governance process; the private and third sectors including the governed/society at large have not been contacted for their values and concerns on their community leadership and manager development needs. Political leaders were required to approve at Cabinet and Parliament levels rather than contribute. A strategic formulator-group member responded: “At least, not directly” (Interviewee 3) when quizzed if they did seek for that. To the implementation stage too, it is found no contacts and communication with service providers and manager developers to know, adopt and adapt Vision 2012 to their businesses. Interviewee 1 revealed that other trainers besides HAUS were Talent Consulting and JPO ry. Following this line showed these organisations do not remember ever holding any session or orientation with the Ministry of Finance on the Vision

when interviewed. It was noted above that Professor Pauli Juuti of JPO ry remembered interviewed and nothing more. Talent Consulting indicated being part of fixing the latest Ministry of Employment and Economy but the Vision was not used for anything there although the Managing Director knew about it as a former employee of the Finance Ministry. An indication that Vision 2012 is not known to service providers or the market as a result of poor or no communication and dissemination. Dr Veijo Nivela of JPO ry does not remember the Ministry of Finance initiation of consultants into any public policy at any point in time.

A University was and has been part of Vision 2012 process; but this relation appears more informal than formal. Two interviewees from Helsinki University who had brushes right at its birth to maturity of Vision 2012 were interviewed and asked if there have been any request from the Government/Ministry of Finance for any management development courses and programs. No's, were the responses. "Have they ever asked you and your department to run some reform programs for them based on this work? No; not; the only thing is Professor Temmes is involved in this small group of follow up of this program; but we don't have any particular role in implementation" (Interviewee 4). Two professors of University of Helsinki and the University of Vaasa are the lead conductors of the Vision's assessment (MoF 2011). However, this relationship is not known to be formal or still the well-established informal. An opportunity to link up to formal higher education curriculum program a leadership development source is missed.

The Vision document has failed to be the guiding source of its own curricula. Do you ever use this document (Vision 2012) to determine training needs of the management development programs was the question shot at the chief implementer and two HAUS representatives both formerly of Vision 2012 working group? The responses appears to be no although they will not put it that way but claim it is at the background. "I don't directly use the document but, of course, I have the principles in my head. At the moment we are talking the need to manage in constant movement. And, then we come to dynamic strategic adaptive leadership and management. [What does that mean?] It means that when the circumstances change you have to be able to change your ways of work, your ways of thinking, your ways of cooperating and you should network better than you have done until now. And, increase movement or mobility in the government" (Interviewee 1).

"I haven't been in any discussion with HAUS concerning this", the chief remarked. And the further argument is that "based on division of labour in the department somebody else might have done that" but not him. But you should know what is going on. And, does it mean there is no coordination in here? "Yes, in that sense", s/he concluded. Yet, it is the chief who signs letters to all the 12

ministries for candidates' selection to the much advertised HAUS-FLP. That is, talking of the structural relationship and job grade of a senior advisor and director-general boss. As a result, the advisory relationship between this officer and the chief is missing. There is no connected functioning structure as autonomy but independence entities right in the same unit and coordination is missing and information is not shared. It is a failure of Mohr's (1982) structural definition views a manager at any hierarchical level and the subordinate to whom authority and responsibility is delegated. And the starting point is common grounds or centralisation before autonomy (Taylor 2001); where initial details are very necessary (Brunson 2008). All these contradict and violate the very value features and practices preached for: central government with shared common culture of the Vision (MoF 2003).

This phenomenon of no communication-coordination observed is further attributable to the silo-slab effects (Mintzberg 2009; OECD 2010), bureaucratic excesses and NPM fragmentations the very culture the Vision seeks to change are in practice by the same reformers. Exaggeratably, each individual seems to be a pipeline. As revealed earlier the reformers at start fail to discuss structure; now they are 'blinded' by their own culture (Morgan 2006); perhaps not as much as required steps out of the own-culture (Schein 2004) to be real reformers of their culture. In an expert system, "every department or unit is independent" (Interviewee 29); so coordination breaks down. Interviewee (15) heads 15 experts; s/he appends signature to their work and pushes it further because, "it's somehow their duty to think what is necessary". It was noted above that even the junior experts work could travel the tall pipeline to its destination unchallenged, not vetted and/or fertilized. The assumption here is that, such juniors' egotism, rivalry, independence and so on could start very early; and the longer their mentor stays the better these grow well. Independence seems taken for autonomy.

Although there was no question on leadership versus manager but one Interviewee (28) viewed the Finnish 'problem' is more of management than leadership. This interviewee pointed to the Finnish word: "*Johtaja*" to mean both leader and manager. He thinks the separation is imitating English language. Perhaps, on a similar direction this study believes in the unity model of effective manager is effective leader (Drucker 2008) and, leading is part of the managerial job (Mintzberg 1979). The interviewee cites 4 departments dealing with a policy related issues among themselves as follows: "Anyway they are now talking but we needed a special working group for that purpose. **I think it is not a leadership issue but a management issue....** Those

silos people, perhaps, they have their own important issues and they want to guard their bases so that nobody can involve in their issues. From my point of view it is mainly a management issue not a leadership issue”.

With such understanding the move will be to include the needs assessment of the manager’s own tasks and the needs of the organization (Dingwell and Strangleman 2005; Selznick 1957). This transformation so far appears impossible as the analysis indicates. The reformers remain caught up with the old thinking and practices. The silos are thicker than thought to allow any meaningful communication and coordination. Information is not identified, disseminated and shared. Clearly, no attempt at extending and developing Vision 2012 policy values and contents into any local or national educational curriculum for the neglected true future leaders.

4.3 Finding: Values and Will are neglected in the process

Value and Will are supposed to be always a match in affecting people’s actions as this study argues based on their theories. To avoid a common academic blunder of not afterwards join up separated elements for analysis or study (Taylor 2001; Eddy 1983), value-will are re-joined for this analysis and synthesis to fulfil their place in reality. Interestingly too, and, as theory suggests, ethical leadership is scarce in supply and barely discussed (Bass and Riggio 2006; Shafritz and Russell 2003). So too, has Vision 2012 core paucity data too on these subjects. To the contrary and importantly, values were the first to be raised by the interviewees (see Finding 3.3 Interviewee 16 and 17) to the final interview question marking the weak demand side of the leadership equation when asked of the prospects for future leadership developments for the country. Vision 2012, synonymous to St. Augustine’s theological foundation that perceive the fall of mankind necessitated government but failing to detail how grace is brought to man in that government (Argyle 1994).

Besides suggesting the pilot of the evoked values (MoF 2004; 2005; no response for interviews from both the bureaucrat and Politian names appended to these documents) did not go far enough and fails to define managerial leadership value needs. Open and conscious value-will teaching and practices are non-existent: None of the interviewees here happened to be part of that pilot or remembers anything of the sort although a state owned legal values – State Civil Servants Act (750/94); not confidential a document. Theoretically, it is expected to have been wildly known and practiced already by civil servants and related academics. The more interesting challenge of the popularity of the document is that it failed to be cited and or

found in the literature of Ikola-Norrbacka and Jokipii's (2010) examination of Finnish ethical administrative values.

Creating own organisational values as a consequence of having no idea of Vision 2012 invoked state values or its source was common with interviewees. "I know that, for example, when I was working in the Ministry of Interior they had values of this ministry; and, we even made our own values for the department where there were terms like expertise, cooperation trust or honesty. I can't remember that" [of the state/Vision 2012] but nobody talks about values in this place (Interviewee 27). It also was common among interviewees to raise this at the end of the interview when their candid advice was sought for: "Honesty", "cooperation", "commitment", "balance", "accountability", "courage" and "trust". They are observed not taught and practiced but purely personal values; thus communicated consciously but not from the government Vision 2012. Bozeman (2006) has told that values are found in the environment and so have this questioning and the willing to tell revealed. In effect, these are telling's of the missing and or expectations of the leadership or system as a whole.

Assuming these are a true reflexion of the Ministerial apex management values then they intercept slightly the Bertelli and Lynn's classical precept of managerial responsibility values of accountability, judgement, balance and rationality (Lynn 2003). This explains the contextual need for Vision 2012 reformers to have gone further than merely invoking the unknown controversial document for its core. In a silo system where the value independent is well known, and self-reporting is the norm; therefore, it was not surprising the OECD (2010) went ahead to report that accountability, individualism, and communication are a problem; hence the collective commitment recommendation; which, in fact, although appropriate but cannot solve the problem by itself without tackling the silo root causes which was dealt with thoroughly in the third chapter to be cultural related to capability, value-wills, ethical manager's capability woes and tool alignment, and the connection to the community and its needs.

Although the system appears to rely on values of trust and honesty (cited by most interviewees) it is largely individualistic or professional rather than inculcated public value based. Considering the overlaps these values go better with the general ethical and democratic values (Pollitt 2003); than what Vision 2012 invoked for the transformation of silo system leadership, its professionals and community at large. The training ignores it, at

least, with FLP despite being the core of its mother Vision 2012 model as its latest graduates testify (Interview 15, 27, 28 & 32). It is one of the taken for granted issues or better still unknown and not understood. It was not uncommon to acknowledge to HAUS's programs usefulness while a challenged is issued. One of such is that: "we have to have some means to orient to the future; but I think this Future Leaders' Course gave some tools for working on that and I think it was useful for me; but I am not quite sure if those there have got it that way; and I don't know, I never found the answer if it is for future leaders or for leaders that are already leaders that want to orient the future; there is always this" (Interviewee 27).

Critically, it was noted almost every interviewee visited at the Ministries reminded the interviewer of their attained "independence" rather than autonomy. Even literature (example, Tiihonen 2001; Finnish Literature Society 1997; MoF 2003) fails to be absolved from this common and popular street word and its usage. This observation might point to the how far and the extent to which psychics and behaviours are affected by the independence value. Vision 2012's value of "independence" was picked and dialogued with most of the interviewees, especially, the formulators because of its controversy to its seeking centrality with common culture. Pondering was observed to set in when this issue is raised; and all agreed to its controversy. It is thought "autonomy" is confused with "independence". Further queries remain of this street word 'independence' value in this direction.

Re-examining Meier and Hall's (2005) triple question about the sort of values connecting the citizen/governed, the politician and the bureaucrat becomes relevant as well as the Redford adjustive activity. This need is summed up by Interviewee 22: "I agree with those who say that our central government is too pipelined. Government Ministries are too independent; and, that I am quite much working with better regulation idea and there I can notice that one of the problems is, there is no really common strategy for the government; but too much independence is left for the ministries". The burning issues may be two: should public officials determine their own values as it happened in Vision 2012 or it should be a stakeholder and citizen issue with leadership being a matter of the community? – Thus Independence versus governance. And, should not the Finnish Government re-examine critically its State Civil Servants Act (750/94) where these values are posited and manifesting in other state documents without any challenge?

The ten values from the Act seem too many according to Peter Kanerva of JPO ry (not aware of Vision 2012 and its state values before interview). For example, Nokia values are three (Hakarainen 2008) while the EC's (2000), five and consistent with their strategies. In the

literature Tony Blair (2010) in retrospect agrees with Fukuyama (2004) on the permanency of values and policy at best only has a brush on culture change. It is Education and interaction with others that makes the solution (Fukuyama 2004). But the reformers have kept things to themselves producing unfertilised (not communicated with community and stakeholders) values and modular training focusing elsewhere rather than government needed program focused.

The obvious miss out of silo value needs of the managerial leadership including the expert and their community is not a surprise: “For forecasts from actions grounded in instrumental values and directed towards intrinsic values are notoriously complex and often catastrophically wrong” (Bozeman 2007; 121; see section 3.3). Having observed the difficulty involved in deliberating on public values and interests; Bozeman notes the agent-relative complexity of inequality and differences that do not permit simple differentiation between instrumental and intrinsic values as a result of the characteristic multiple valuations for the same object. The double difficulty here for policy formulators and public managers are the possible conflict among values and the difficulty in connecting instrumental values to intrinsic ones or to real outcomes. Viewing Vision 2012 in this situation its “Effective communication” appears as a competency for skill development far from the core values and non-existent in the invoked state values (MoF 2003; Figure 6: 94). It is, therefore, an instrumental value or a means to an end. But for the invoked core (efficiency, quality and others) to be effectual, effective communication as an intrinsic value or an end in itself must be attained in the core to open up, set the stage and enabling environment for the necessary connections. Communication to this study has both dual instrumental and intrinsic value-will particularly, for silos developmental processes; as it narrows and does not permit free communication (Mintzberg 2009; OECD 2009).

Apparently, the entire Vision 2012 processes are run more on, informal and non-scientific basis (OECD 2010; Vartola 1999). A scenario of interests group against players or power group (Bryson 2004); therefore, following the path of least resistance (Dunsire 1990), in the process; yet communication and honesty amongst them has been unyielding. For instance, the chief remembers doing things based on her/his observance of some bureaucrat’s leadership interests (note it is on values not skills): “I think I was picking up those people for the project; ...I know all those people and meet them regularly”. Note from Finding 2.2 that this trust reposed in these chosen people failed in fruition due to lack of understanding and non-commitment to their own work among others such as capability. Such disparity called for a second clarification

interview with the chief. This interest group is too weak and nonstrategic to understand values-will and, especially, *open and free will communication* let alone take it up to the players, context setters and others connected with Vision 2012 for formalisation and further action of implementation. This feature of communication unwillingness failed to be hidden from this study as hinted already. Its follow up questions had problems of eliciting further responses despite promises of cooperation, an act of non-commitment.

Mintzberg, Colvin, and Bass and Reggio three different Leadership Models (see pp.86) explain away the elusive craftsmanship or statesmanship leaving a bereft manager of this era void sitting in his/her comfort zone while policy and implementation suffer. Truly to this assertion one problem of Vision 2012 is viewed as a comfort zone issue by the Interviewee 14: “[Y]ou cannot teach old dogs new tricks”. S/he further observed Finnish system is legalistic and fortunately, Finns are generally law abiding. And, for her/him, managers must learn to “take risks” in spite of the laws, based on having “strong minds and strong will”. Thus the impetus towards crafting or statesmanship; but building the basic value-will ingredients has not featured anywhere yet, not even from the graduates of the FLP program. The reformers have failed to see and understand the importance and power of value-will as creative force, and operational tool (Olivecrona 1971; Bozeman 2006; 2007; Pollitt 2003) for the individual and group/society and on the other for democracy and governance basic implementation processes. Such failures lead to social pressure mismanagement (Selznick 1957); obsession and invidious behaviours (Sennett 2008); and, similar ubiquitous elements that damages structures (Mohr 1982) running organisation to where they are today and seeking reforms from the tall independent silos.

The reformers have failed to get through to understand their own model core “Will to lead and develop” (MoF 2003; 16) and, to serve (Kanerva added). A decade of implementation failed to note what the independent value means and whether it should be expunged or retained while the reformers seek centrality, common culture and collective commitment. Bozeman (2007) explains the problem of independence versus collective: thus the possibility of one achieving some sort of desired ends only by collective action at the expense of cooperative ways that prohibits action toward other desired ends; then the rational weighing becomes the worth of what is achieved by collective action versus what is lost by submitting to collective moral governance. Respectively, both Public Policy and Law converge at collectivism: Whereas the Inductive Contractualism Approach collective action should be

based upon existing shared values, social contractual recognition and voluntariness of the individual (Bozeman 2007); the Will-Power theory (*Willensmacht*) is a right and a power of the individual as well as an arena wherein the will is ruling on the basis of consent to others (Olivecrona 1971). Such overture to buy political support in the reformer's implementation plan (MoF 2003; 37) remains undone.

Politicians, the very frontline leaders and decision-makers, obviously, were out right at start but with a plan to bring them aboard. In Finding 4.1 it was found no political communication and supports for Vision 2012 were forthcoming. “[O]ne of the short coming was the political world was not taken into account at the same time that we were considering the public official's world; let's put it that way. But there are some tension between civil servants, between civil servants and political leaders; and it's a question of power. Because some politicians do not see that good quality management among officials is for their benefits. They see it that if they have strong and capable civil servants as leaders it would take some power from them; and, of course, that means that the politician is afraid of quality management; that is how I put it” (Interviewee 1). This is synonymous to Riggs' (1994) Congressional fear that stalled the American bureaucratic mandarin development.

Taking it further down on the relationship, Interviewee 7 evinces the top public official and the political master's responsibilities. “I think one of the important issues being that sort of director of the government agency or permanent secretary in the ministry or whatever in leading position you got to understand political sort of life or thinking or relationship of the [political] parties. What are the sort of values or ideologies of the parties; because, otherwise you are lost. You cannot understand why there is sort of guideline as they are. And, if you don't understand this you don't have the means to sort of have the discussions with the politicians. Because the main thing from the experts, like us, is my right most duty [to] explain to the minister [that] if she makes decision like this what are the following; what are the effects and what follows if these are these? If she thinks about things I have to explain the expertise – costs and following impacts. So it is information. And, it's not sort of right thing; it's a duty to tell her; it's her responsibility if she follows the guidelines. I am sort of free after that... And that is sort of basic but to do that you have to understand the sort of political decision making process in parliament, and the state council and ministries and rules of the ministries; and you have to also sometimes say that is not possible [the wise counsellor's theory (Pollitt 2003; 87)]. We cannot do that mainly because the will always be things like this [the bureaucratic theory (Pollitt 2003; 87)]. And that is what I think the public administration has given me a sort of basic knowledge about the public administration, constitution for the government...”

This politico-administrative dichotomy is not a new creation and attempts at bridging include the 1969 Redford adjustive activity signifying public management and Mostein blending political and administrative thinking (Lynn 2003; Tiihonen 2004). The quotation above

hinted on at the early part of the quotation followed by what could attract criticism to the public manager from the politician (Pollitt 2003; 86-7). This interviewee advances further that top official's predictive abilities should be powerful; based on following the news and events one should be able to "know what is coming" in facing Parliamentary Committees and the likes. In terms of values Pollitt (2003) argues democratic values serve common good, supporting elected officials and not sectional interests. Unfortunately, these candid observations and values have failed to impact on Vision 2012 processes as interviewee 2 puts as when talking about affluent and influential people who make things happen; "we haven't convinced those people enough for the urgency and need of this development track to go on; and even be stronger on the track". This is probably the biggest problem of the formulating and design group for failing have on-board right at start the power players and context setters in the system (Bryson 2004). As such no visible political will bought for Vision 2012 survival and health (Drucker 2008).

The OECD's (2001) expectation of leadership is the actualisation of values to guide the public officials throughout the system while embedding them in the culture setting the stage for the desired kind of leadership. Success prerequisite features for this process are non-existent: Discursive communication as the action plane; the managerial leadership generated value-will information and skills; as well as, the connection action of their culture embedment for the future leaders and collective commitment.

4.4 Finding: Culture was never considered at any point in time of the processes

The reader might realise that culture [of the silo] has been dealt largely above already from the start of the analyses and will not end in this section but continues throughout the work. That informs the extent to which it pervades life activities. Although culture change fashion is caught up with Vision 2012 nothing specific appeared in the interviews to have been targeted for changed or have been changed besides the piloting of tensed fixed term contracting changing the traditional career for life. In the literature, Schein (2004) demands what of culture to be changed? The OECD notes above that values are embedded in culture so does this study view culture as the source of values. And, societies may be well vexed in some values but suppresses others (Sennett 2008). It, therefore, cannot be left out of the reform but to be a determinant force (Desan 1989).

Understanding this power and culture levels reforms (Blanning 2002). In Europe's nation-building theory of Stein Rokkan (1999) culture including the church featured prominently as well as cross-cutting the other key elements of military-administration and economic; it is out of this cultural process that Finnish National Languages and Finnish identity were established. Communication has all the time been perceived in this study as a cultural issue even as it appears under the different headings. That implies once again the study is viewed institutionally as the ways of thinking and acting are culturally governed (Rhodes 1997; Brunssen and Olsen 1993).

The (institutionalised) Finn and communication identity: It was easy to identify the Finn from the interviews of the well cited Finnish-Swedish comparisms: "If they [Finns] are stubborn they are pragmatic; and they want to solve things; ... we cooperate usually better with the Swedish; they are better in lip-service than us" (Interviewee 12). "The Swedish are much better in communicating"; the Permanent Under-Secretary admits and concludes: "We should have a good balance of listening and then doing". It has also been noticed that the managers are unwilling to communicate formally although they all claim having wide (informal) networks around. [However, none in the Ministry of Finance interacted with could connect researcher to the ministers for an interview]. The Under-Secretary further recognises that at a certain level of top administrative posts the manager's job is to communicate fluently, and skilfully (Pfeffer 1997; Hackman and Johnson 2009; Pettigrew et al. 1993). This fluency (and skill) is already a problem something consistent with Professor Teemes' observation. In addition, the Permanent Under-Secretary identified that some of the managers do not see that communication is part of the managerial job (Drucker 2008; Mintzberg 2009; Hackman and Johnson 2009), they are presiding over; concluding: "it is communication that keeps the dialogue going on".

Interviewee 26 thinks it is not per se the culture but the law that makes people behave the way they do. Another (Interviewee12) explains: "Ministries in Finland have been very independent; so they have. Finnish people are very stubborn sometimes; they consider they know the best and not you; so, they adopt this; and that has been to some of my personal view; now, to some of my personal opinion that has been a certain kind of evolved, should I say. ... Some people say that our management approach comes from our, err, close military in heritage; meaning that after the second World War very many managers were those officers from the Army; and, in the Army you don't negotiate; just take an order! And this has sometimes [been] called the management by "perkele"; it was true earlier but it's not true today. But I really want to, that we negotiate things here; but when we have negotiated, I want that we now decide and after we have decided I don't want any more to retell this because otherwise the ship starts to shake".

The story did not end there but continued across Finland borders: “There are really clear cultural background that is why we are pragmatic; we don’t speak so much and we go direct to the issue; that is true; and, I don’t want to change it very much because it is our way; we are not impolite; but we don’t use so much decorative words; and, that’s ok; that’s why we don’t have any difficulty with the Swedes, or the Norwegian people and the Danish...” (Interviewee 12). Indeed, the “management by perkele” may be gone today but not without leaving its shadow behind as inferable from the quotation “...after we have decided I don’t want any more to retell this otherwise the ship starts to shake”. It is as if to say after the decision nothing can go wrong and new thinking is not permitted. An observable common trend expression from other interviewees along similar lines, for example, were that “they can say anything” but “I decide”, “I make the decision” authoritatively and, individual leader’s opinions are strongly guarded and rarely open to pollination and fertilization from their subordinates or colleagues. It is a situation interviewee 8 admits to.

Notice had been taken already (Finding 3.2) of this “my way” and “his way” against “our way”; and now “I” still against “our” have broken the back of leadership by example at the Ministry of Finance. Yet, Finns and the Nordic region described cooperative and consensual according to researchers (Brunssen and Olsen 1993; Peters 2006; Pollitt and Bouckaert 2004; Hackman and Johnson 2009) and some interviewees (6,12,14,...). But this tradition affects implementation (Christensen 2006). Cooperation may only bring peace and not performance (Brunsson and Olsen 1993); and not necessarily even understanding and more importantly eliciting action as the core Vision 2012 formulators exhibited by shirking off responsibility and trust place by a colleague. Cooperation is lip-service: “There is a lot of informal networks... but in creating systems where the ministries are put to cooperate more together there is the tendency not to solve the problem of responsibility. If you have kind of joint responsibilities then there is big risk nobody is taking care of. [Nobody is responsible?] No!” (Interviewee 15). Further blurring of responsibility may be found in “leading group” concept as mentioned in earlier (pp. 146) depicting them to be on one or another.

Earlier on, the chief implementer and a subordinate were asked how they have massaged the imported knowledge and best practices (Fukuyama 2005) which speaks of teamwork, networks and collaboration (MoF 2003) to fit the ‘individualistic’ Finnish culture. “I don’t have the answer” (Interviewee 6). From the other: “Well, I haven’t thought of that; and, it doesn’t seem to be a problem in my view”. But following a short and systematic dialogue that view shifted position.

The chief asked the researcher: “Do you think Finns are individualistic? Yes! Listening to the street language they speak such as ‘I can do it’, ‘I can do it for myself’, and ...” S/he interrupted quickly: “Don’t tell me what! Ok!” But continuing: “...So, it makes teamwork, it makes networking and ...”. Interruption again: “Ok! Well, now I begin to understand; in that sense we have things to learn because networking is the key element to appreciate other peoples knowledge and experience. Yes, yes; in that sense I didn’t understand it the first time. It’s a problem, yes”. Collective action is preferable to individual action (Bozeman 2007; Caiden 1994). Perhaps, that is one reason why Vision 2012 seeks centralization and common culture (MoF 2003), but has failed to identify this communication weakness inherent in the culture that directly affect their goal. It is a neglect of Hunt’s political culture definition as “values, expectations, and implicit rules that expressed and shaped collective intentions and actions” (Blanning 2002; 4).

That individualistic question has been based on most of the books and articles reviewed for this work. They are American and Western generally. “The ‘critique of rootless’ rationalism goes hand in hand with an unmasking of anthropocentric, egoistic, possessive and domineering aspect of Western individualism; together they serve as a prologue to the rejection of central European humanism” (McCarthy 1984; x). For instance, one concern of Herbamas’ (1984) theory of Communication Action is to develop the concept of rationality that is no longer tied to, and limited by, subjectivistic and individualistic views of modern philosophy and social theory. In reality, Professor Guy B. Peters, in an interview revealed the “American culture is more individualistic than Finnish’s”. Writings from such an individualistic culture and conceding to failure due to the inability to learn and adapt is eminent. The success of the Japanese institutions and organisations had been praised for adapting Western administrative and business culture and successfully localised (Fukuyama 2005; Morgan 2004; Pollitt and Bouckaert 2004; Bower and Weinberg 1988; Sennett 2008).

Peters (2006) wrote, it is not easy to work across units of the same department in Finland should be considered, indeed, worrisome as this and other findings are consistent with the literature. For example, the reviewed showed the reforms are of low priority in the Nordic Countries including Finland (Brunssen and Olsen 1993); and the OECD (2009; 2010) showed the system is siloic, individualistic and political party interests dictated the pace as against public interest and central governing froth with communication difficulty. Furthermore, structural artefact (Mohr 1982) review of the Finnish silo (OECD 2010) in the fourth chapter and earlier parts of this section demonstrated the politico-administrative structure is distorted

and nobody really is placed to have a total view of the country. The constitutional reviews have played key roles in this fragmentation and distortion from, traditional practices of collegialism (Tiihonen 2001) and Presidentialism to the Parliamentary governance comprising independent ministries. The Prime Minister's Office (2010) communication bulletin beams at the media neglecting its own institutional internal difficulties.

To this point in the evolving cultural leadership analyses the Finnish public manager fails to be, the centre of information as the structural artefact denotes, energy centre of the organization culture (Mintzberg 2009), of the Ministry or department being run; as they continue to do their specialist stuff (Interview 13; 16; Mintzberg 2009) as such is unable to identify, shape and project any culture of change. This is well underscored by the Permanent Under-Secretary and his predecessor with private sector credentials. Respectively, while the former notes that the on-going productivity program of which the OECD (2010) is critical of should have been done some 50 years ago; the latter Dr. Juhanni Kivela, confirmed he was the implementer not its architect. He thought the 1993 recession aided the process. Suggesting crisis promotes reform (Fukuyama 2005; Schein 2004) and its implementation against stubbornness which might have been transmitted and imposed by earlier leadership views and assumptions (Schein 2004) unconsciously considering longevity and poor mobility in the service (OECD 2010).

Tall strong presence of hierarchical traditional structures, culture and status maintenance although in modern society, generational and communication gap experienced at Vaasa University are apparent in the system. But the general view from interviewees is that things have changed and improved a lot compared to even a decade ago. Some think this improvement could be attributed to belonging to the European Union participation where one is 'compelled' to talk especially when you meet the French and others labelled talkative; moreover, "the process is negotiating and dialoguing" (Interviewee 12). The suggestion to this point is that the 21st Century Finn as viewed by the Finnish Literature Society (1997) is becoming sociable and communicative with generational changes. Perhaps, this is due to globalisation and its normal everyday actions but not necessarily from a conscious effort of the state. "We Finns are not very talkative. We are learning here in Prime Minister's Office to become talkative because we have this new salary system where heads of units, and employer and employee would have to discuss in a frankly way; so that is not typical for a Finn to discuss issues in frankly way" (Interviewee 26).

The reformers have failed to recognise communication cultural value and valuing processes (Calhoun and Sennett 2007; see Bozeman 2007 above). A further step was taking to ask specifically if the courses and programs contained something specifically (Finnish) culture. It was perhaps the most funny and bizarre of the interview questions as well as its answers. Have the reformers ever discussed Finnish culture with you before? Obviously, “no” was the answer to start with. And, for the bizarre: “but I am a Finn! (Interviewee 28); “No, I have never thought of that” (Interviewee 27); “The question is difficult when one has lived all his life as a Finn” (Interview D in Focus Group, Public Administration Committee); “Mmm... Not really actually; once I remember this course, a lecture about Chinese culture about 15 years ago; I had a meeting, a conference in China, Beijing; and then somebody came from the Ministry of Foreign Affairs came to us and told us how to behave in Chinese culture; I wouldn’t call them courses but some small glimpse” (Interviewee 21). “Not after school; I studied history ...” (Interviewee 5). These responses are consistent with avoidance or taken for granted or mechanistic views of culture in organisational studies (Pfeffer 1997; Fukuyama 2005; Morgan 2006), and reform implementation.

Interviewees’ expression of difficulty, taken for granted, and unawareness of own culture may account for lack of understanding, inactions and lapses. One part of the slab is that culture is taken for granted and not understood because the reform is European and Finland is in Europe and part of it. As noted from interviewees no culture introductions are made as they move around and within the sub-continent. Vision 2012 reform had combed for ideas within Europe: “An international survey was also made, comprising a comparison of management developments in the Netherlands, the United Kingdom, Denmark and Sweden” (MoF 2003; vi). Although internationally acknowledged, the opposite side of the slab is that the survey failed to see and understand the local cultural differences as perhaps, it is all the same and one Europe, a taken for granted and no attempt to understand the matter properly and for the appropriate instrumental communication value as reflected in this observation: “I think membership in the EU, of course, now that we have to be more in organisations and management styles and the working styles in other European countries; I think that has also made us more open-minded to influences from abroad so that it has been a very useful exercise. It has been a very interesting experience. Generally, Finns do well in the EU. For instance, we are not that aggressive as the French but I think our word is listened to. I have worked with the French in the OECD and I have noticed this” (Interviewee 17).

Vision 2012 is a decade old already and not much appears to have been implemented. With Kivela doubting its success; Interviewee 14 whose jurisdiction it falls complained of lacking its directives such as requisite tools and, mind-sets (Morgan 2006). Continuing s/he remarks:

“I think all other things are easier, but for the mind-set it’s tough” (Interviewee 14). The chief implementer accepts they have spent too much time in the board rooms and lacking ideas to communicate implementation. At least, taking it from the core formulators (some indicated they were on new projects of this sort) understanding and delivery of their own work has been impossible and difficult. This is something the Finnish Constitution frowns upon: Section 118 on official accountability expects people to be responsible and committed to something that they have been party to creating yet it goes on.

Unfortunately, interviewees comments “such beautiful government papers are common” does not sit well in a democratic system as well as institutional all time quest for efficiency. From these perspectives it is possible to corroborate with the OECD (2009) that the Finnish system is a super expert culture with no place for soft tools. [E]ven from the private sector they say that this is specialist organizations (Asiatuntia Organisaatiot); specialist organizations are the most difficult to lead” (Interviewee 12). Also, from the private sector they are shocked when they hear what goes on here (Interviewee 8). Lip-service and informality abound although there is the claim to pragmatism. Crisis management is seemed favoured in the culture as its history suggests. As a result, the politico-administrative culture also harbours tension. Accordingly: **“You have to watch what you say to people”** (Interviewee 12). This may challenge office democracy.

The search for answers for this Finnish Managerial puzzle becomes even more apparent. Back to the policy home/owners for more information to the chief implementer, whom in the first meeting it was put as to what was culturally unique objective or problem to the Finnish Management before Vision 2012 as it lacked baseline information typical of reforms (Lynn 2003; Pollitt and Bouckaert 2004). “Well, this manageristic feature of leadership is, I think is very general in all the World, Eastern and Western World; and, **in Europe it’s about the manager and his/her skills**; and that is one thing we have wanted to break; but in Finland since the second World War that this manageristic aspects has always been strong; and, let’s say **in Finland, Sweden, for example, the boss says, people listen and do what he/[she] is saying**; and, that is something we have to; there is something good in it, of course; **if people are experts in their own fields they are not told what to do and what to think, and how to learn to do things better; so that is something we have to change very much**; and I think there has been progress; but it’s very personal question and every leader has to go look at himself/[herself] and start to learn about their own behaviour and what is expected of that”.

Pocketing the ‘know it all’ definition bolded above, a pushed further to identify more precisely any other thing Vision 2012 is up to solve in the second meeting, six months later,

the response came as: Ok, “I am not sure any more as time goes by if it is today exactly the same; but in a way, in the government sector **the problem is the attitude, the approach to management and leadership**” [Interviewee 10 and 28 concurs]. Explained further to mean top level civil servants kicking against ministers’ and/or government’s decision and that amazes private sector visitors who claim to discuss not further after decisions are made [remember private sector manager’s tallness (OECD 2010) and history in the literature]: “**more unwilling to do what they are supposed to do. It is very damaging to the personnel in the organization because they need their bosses to say what to do next [kills initiative of the subordinates]**. And discussing sometimes even publicly in the media; that I don’t like [Interviewee 6 too]; there are exceptions; but there cannot be such exceptions anymore; everyone has to do what they are supposed to do”.

This observation is detailed and expanded by the Parliamentary Administrative Committee Focus Group Interviewed: “Earlier our chiefs in the civil service have been **more experts than managers or leaders**; expertise has been more important; but nowadays management and leadership are becoming more and more important. Leadership has a strong role in our system. Many other countries have the same problem as in Finland as we have had in a way experts in leadership of the departments. **But it’s so that you have been chosen to be leaders when you know very well the expertise of the department; and, then perhaps, you didn’t have the leadership to lead the other people.** That has been under discussion in Finnish governing system about 10 – 15 years ago. We manage quite well when I compare to many other countries when you see something then **you don’t ask questions. You just do it.** In Finland we are trying **to change the attitude so that you discuss more and make decision together.** And, **the leader has to be able to convince the people of the idea and the direction where we are going to** [reflects crafting processes of communication; see also pp. 76 for Lynn’s (2003) citation of Millet]. **And that perhaps, needs new people; then already, it needs education. [This is the escaped core part of Vision 2012].**”

The group further notes the constraints of the ministries. “Our system is like ministries don’t have very much cooperation if we need each other. **This problem is not new.** But it has not been easy to change to develop them. There has been some small progress”. The reasons adduced were consistent to the OECD’s (2009) that the different ministers of the coalition to the different ministries. What is new is the competition amongst them and how they appear in Parliament with their government business matters. “But coordination has not been easy in many times”. “Perhaps, the Prime Minister’s Office should **be larger and more powerful than it has nowadays** ... so they could apply their time to see that the things in **other ministries run together.**” This is a gap that is substantiated even further off political and media apathy to reforms in Finland and the Nordic region (Brunssen and Olsen 1993; Pollitt and Bouckaert 2004). Assuming this identified yawning cultural gap is bridged then “I will say that big changes, big **reforms the starting point is political**; it comes from the

government; **it is very hard for these people who are established in the government for them to see the change**” (Interviewee 14).

A detailed probe was necessary following the Focus Groups exoneration of Parliament from leading role to government, that is, ministers and top bureaucrats as mandated to take care of the leading process. “So, the top civil servant does not just take orders? Mmm... Yes, because it’s a bit new; in a way we are used to the previous system that civil servants themselves prepare the reforms to put the organization together or not. Now it is the government who takes the decision and we have to start implementing from day one. So what it means is that the politicians don’t also discuss with civil servants? That’s true! So, is it actually that the top civil servants are resisting because their political masters are dictators? Yes, and the politicians are dictators because they have learnt that if they start to discuss with the civil servant it will end; they will lose”. Explicably, the Finnish politician lacks the knowledge base support of, Think Tanks as well being out of touch with the Universities (OECD 2010). Furthermore, time constraint of the politician (FGI). All these add up to the already information asymmetry to the bureaucrat’s advantage (Torenvlied and Thomson 2003). Torenvlied and Thomson acknowledge implementation as part of political bargaining of which the Finnish Managers both bureaucrat and politician appear to be lacking. Thus the two sides are separated by values, will and capabilities embedded in the culture.

Although culture change reform is in vogue it continues to be poorly understood and adapted (Dingwall and Strangleman 2005; Shein 2004); as in this case believe in expert leadership, politics and coalition politics weaknesses had brought the Finnish system this far. Vision 2012 is a challenge and first of its kind to the expert leadership (FGI). Besides communication and coordination difficulty two important contentions and dichotomy of the Finnish Public Administration found are that it is consistent that Traditional Finnish Expert Manager/Leader is not told what to do but dictates what should be done. Also, the data reveals that most Politician Manager/Leaders relatively younger compared to their older civil servants are thought to lack managerial experiences [and experiential expertise]. Whereas the traditional bureaucrats specialist leaders fail to find and kowtow to the new governance processes; Vision 2012 fails to identify the necessary communication instrumental value suiting the environmental and its development to challenge the situation. The evolved culture seems not to support centralisation and implantation processes; but maintenance of the silo status quo (OECD 2010).

4.5 Finding: Management by objective without common minds of Vision 2012

Drucker argues Management brings people of different domains together to perform particular functions in Government and organizations based on knowledge, skill and experiences. This management processes affects all as such all must be concerned (Mintzberg 2009). MBO or management by objectives aligns with Hoods perfect administration model in character including communication commonality. Both Interviewee 14 and 2 (were involved in the importation and conceptualisation) pointed out the Finnish Public Administration is run based on MBO, the philosophy of management (Drucker 2008; 267), which is an innovation by itself (Loveless and Bozeman 1983) but fails in this silo contextual process as either “means or ends” (Mohr 1969; 112).

Contrary to the NPM/HRM specialisms and individualism (Taylor 2001), the philosophy emphasises right at start befall collectiveness and teamwork, and team results (also Caiden 1994); furthermore, for balance purposes, effort is made so that the objectives of all managers on all levels and in all areas should have both short and long term characteristics; concurrently with both tangible business objectives, non-tangible objectives as manager development, worker performance and attitude, and social responsibility. The analysis so far in comparism to this claim of running MBO in tensed silo-slab system constrained with communication is very debatable. Take, for example, Möttönen’s case study of two Finnish municipalities concluded that it does not work as the politicians rejected the role assigned to them by the MBO model (Möttönen 1997 in Tiili 2008; 127).

Guiding this study has been the rational manager’s own goals, and values that still remain as unexamined as those of traditional corporate bureaucrat, inclusive of the non-alignment of the manager’s toolkit as well as the consent of the governed (Dingwall and Strangleman 2005). The study guide falls in line with the philosophy of implementation communication for knowledge, understanding, value-will and capability of the ultimate business goals of government. Furthermore, what expectations and why, what is measurable and how that is done are the key features all the managers involved must know at start (Taylor 2001; Drucker 2008). More importantly is the meeting of minds within the entire management within the unit and levels; labelled here as the **common minds principle**. The system, therefore “must be built on *communication* and on *individual responsibility*” to achieve this as the people perform different functions (Drucker 2008; 24); particularly, by verbal and direct

communication for understanding (Herbamas 1984; Branson 2008; Hackman and Johnson 2009; Bryson 2004); clearly one's objective and subjective responsibilities explicated by Mosher (1968 in Lynn 2003).

Vision 2012 failed to construct on this principle as a result of poor and or no communication for understanding and transforming its ideas [compare Finding 3.2's failure of leadership by example]. From this analysis the dichotomy is laid bare between reality and theory in the same department as the chief recognises that "we [Finns] cannot pretend to cooperate at individual level; and, in fact, we don't". Yet, at the other end of the cultural-management continuum the boss, the Permanent Under-Secretary and a subordinate proclaimed: "we are trying to make those people meet together and consider the corporate level policies" of government. Between these divergent thinking lie this analysis of Vision 2012. Suggesting a failure to identify the very basic challenge of "my", "his" and "our" way on the one hand; but jumping to the other, virtual cooperate level. This tells the reformers fail to agree on a common mind on the exact need idea at the start; but are propagating different information, if at all, at their different levels.

In another development, the Vision deals with only the government manager: the Permanent Under-Secretary and 3 others (Interviewee 2, 6 and 8) aimed at making Government employment attractive having recognised the competition with other sectors, notably, the private – no mention was ever made of the third sector or KEPA in the process. However, they failed to incorporate the other State roles as the agenda setter, facilitating, supporting as a whole the human resource management sector of Finland as an entity. As a result of this silo thinking (OECD 2010), the Vision ideas showed nowhere its short term (internal or within government), medium or long term program (outside government) although it raised the issue of recruitment and job banking development – see diagram below. Or, did they show it is a national program as it seemed to be between the silo string of Government as Employer Department and HAUS.

Taking implementation process as evolving (Hill and Hupe 2002; Younis and Davidson 1990) and considering from the Vision's planning to this stage of implementation, it fails to include other sectors and the community (Finding 2.2), and its contents for action as well as general feedback. Aside its narrowness and short sightedness, its consistency for coherence is also lost as a result of failure to retreat and share the idea at any point in time with implementees and implementors. Both the reform policy and its implementation demonstrate

no pooling process of its visionary goal for: "... constant renewal of government operating units [and systematic development ensur[ing] the availability of future leaders ...” (MoF 2003; I and 14). Amid poor communication for understanding it was not surprising; therefore, that the Parliamentary Committee on Administration FPI interviewees noted the pooling was NOT the problem for the management development bill rejection. But they viewed it as a closed system for some selected few for top positions termed *muodostuu tällaisia suljettuja*: “The pool was not the problem. The problem is that it was closed. People couldn’t come to that pool from outside. Those who were chosen were chosen and posted from; and, posts were filled from those persons; and, no other persons had the chance. They were thrown out. Also, the idea that a person that had been a long time in one ministry would be just thrown to another without any question.”

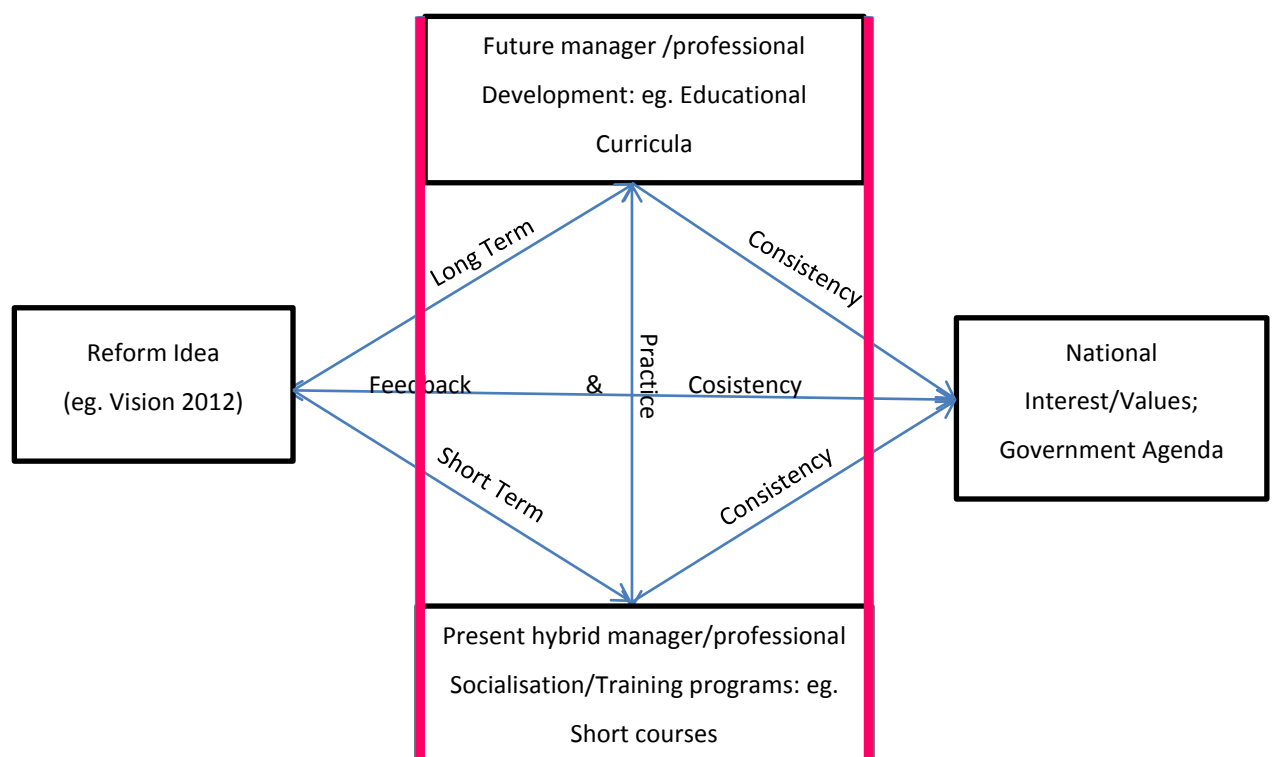

Figure 14: A model for analysing Government reform idea by common minds principle of communication

Grapevine information at the Prime Minister’s Office (Interviewee 15) also indicated it was this misunderstanding that caused the uproar among civil servants. From the data, understanding this pooling was problematic although majority of interviewees with mobility experiences accepted the mobility concept as relevant. These views make it impossible to wholly accept most interviewees’ “politician’s fear of competent civil servants” factor. This may also boil down to Temmes’ Finnish leadership sensitivity and poor understanding and dissemination of the mobility strategy concept as seen already in others above.

Figure 14 above depicts such a pool between the two broad poles in the middle – of the reform idea and the national interests/value boxes. Both the internal hybrid and the external potential future managers are socialised, trained and developed; and, importantly attracted to the institution from others without. It is about making one's organisation/institution attractive to both the present and potential (future) from the open market point of view (Boxall and Purcell 2008; Shuler and Jackson 1996). This is, perhaps, the NPM/HRM conception of acquisition, utilisation and disposal by contracting, motivation – performance pay and appraisal (Brown 2008; Reichard/PUMA 2002; Taylor 2001). Also, it includes maintaining these employees and motivating them for best of performance based on economic and social benefits (Reichard/PUMA 2002; Boxall and Purcel 2008). Boxall and Purcel emphasise on agility, coherence and consistency of HRM in organisations and the alignment to the market. These points to the deficiencies of Vision 2012 itself as a policy, its implementation and training design (Van Wart 2005); include lack of a fixer (Bardach 1980) as there was no program champions, supporters, and leaders (Bryson 2004); rectifiers or advocates (Loveless and Bozeman 1983) sighted from their processes.

The demonstration of poor interaction, negotiations and bargaining among participants to Bardach (1980) is a clear indication of taking no control at any stage of the processes by the reformers/change agents. This common mind principle requires both formal and informal social communication and coordination of the reform idea between the organisation and its environment following diagram above. It considers timelines. It also demonstrates the public manager's influence of innovative actions and processes through awareness, interactions, matching and redefining (Loveless and Bozeman 1983) as the new culture is evolves (Calhoun and Sennett 2007; Morgan 2006). Mintzberg (1979) identifies this process as structure of organization; and, defines it as the sum total of the ways in which it divides its labour into distinct tasks and then achieves communication and coordination between and among them. In that, they can speak the same language based on collective skills (Senge 2006).

No such systematic process is seen of Vision 2012 and its own or other public managers. As noticed throughout the analysis no evidence was found of the group processed having any socialisation/training or education specifically organized by the Visionaries for the Vision in that manner of blending both the former and informal. For instance, within the Ministry of

Finance synchronising budget and HRM failed (Interviewee 6) but the chief is hopeful “we have to find the same language with them” in the future. Interviewees 9 and 13 when they took their posts in Helsinki from the hinterland as top managers they were never socialised or taken through Vision 2012; or do they remember benefiting from any Ministry of Finance manager/leadership training programs while at their previous posts. Vision 2012 lacks influence as a result both within and out of its home Ministry.

“How then are you managing as managers or leaders?” question revealed, perhaps, the most salient of their self-study (Van Wart 2005): While the former having realised the dynamism of the new top job being totally different from the previous routine job in the hinterland, reading and contacting professional friends (including a psychologist) provided the adjustment required for the new job; and the latter who was only couple of months in the new post believes not in reading as the job has been learnt largely through experiential (mentoring, observation and devotion). Both approaches and experiences are without the so-called MBO processes and very independent of each other and of the Ministry of Finance.

As already noticed of Finding 2.2 even the formulators having disbanded were never contacted again on Vision 2012 implementation; as well, no feedbacks of formative evaluation have been organised to ascertain pit-falls and short-comings at any point in time. These chronicles confirm the paucity and or no communication for implementation strategy and there is therefore nothing to coordinate on Vision 2012 original idea let alone its upgrade. None of the policy owners talked about the tension in the contract piloting exercise; rather it is seen as a success story of the Vision suggesting no feedback mechanisms are set in place. This can explain the lack of evaluation utilization (Patton 2002) process in the Finnish Public Administration system; although a regular feature (Pollitt and Bouckaert 2004). Thus, in totality neglecting the process approach whereby goals, roles and methods face constant revision (Hulme 2001). All these put together suggest the non-recognition and usage of the system’s MBO. Or it rather confirms more of its practical non-existence. Furthermore, it explains the system’s siloic knowledge, understanding and view developmental process. The reality is totally different from the paper work.

4.6 Finding: The Features of Vision 2012 Strategies: Mobility, Coordinating Unit and Fixed term Contracting and Common Central Culture and Pooling System

The target group, institution, contents and time do matter in management development. From the literature analysis it was found out that the Finnish Government System lacked the facility to develop its public managers systematically but for HAUS and its “one-shot” unworkable and unrelated solutions. An example, the Ottoman Turkish pasha or top level bureaucrats took 12 years education to perfect the young future fellows for the job (Heper 1994). That FLP training cannot build and perfect a manager, as very little is codified in management (Mintzberg 2009) for that matter to be taught in that process. The reformers themselves to establish a small coordinating unit to oversee the Vision’s implementation and its future processes, particularly of the pooling (MoF 2003), is yet unborn due to “lack of ideas” (Chief Implementer; Interviewee 14).

Finding 4.5 already told of no central common culture and pooling system in the Finnish Public Administration. This demonstrated that it has no common basis for employment as things seems to depend on individual Ministries, personal values and interests of the individual elites rather than national. The accession is partly based on the study accounts and topped up from the recently published *Selection Criteria for Senior Management Posts in Central Government* purported to have been done with the collaboration of the other ministries (MoF 2011). This is a structural problem bigger than the thinking exhibited propping up the reformer qualitative capabilities (Temmes 2004) and the extraction capabilities of the public manager (Nigro 1983). It is silo thinking against a broader issue as such it has becomes an insurmountable task exacerbated by the political apathy. Oversight responsibilities are shirked naturally in such a tensed silo-slab system. More horizontal problems are therefore created (Brunssen and Olsen 1993) as all look up to the top (Glombiewski 1983) that may not know and therefore nobody knows (Caiden 1994).

For example, all the ministries dealt with had their staff mobile within it and sometimes to and from outside the country for EU missions. There is difficulty to manage between the sectors as turfs are fenced tight and the so-called hard productivity program dealing with numbers instead of capability and other human resource developments. In two ministries it was noticed they are overstaff by one each, that is they ‘forgot’ of their own staff while on duty tour to and from the EU. Not even on such local tours within the country make any

difference as things are left to chance. The Prime Minister’s Office observed that “when we want to give them back after 5 years, ... the sending ministry had forgotten that they have one person here”. The Government as Employer/The HRM/Personnel department fails in its function or nobody is taking charge of transfers and postings nationally and locally in the ministries and agencies. This is the consequence of independent and fragmentary systems promoted by NPM/HRM reforms and bureaucratic excesses. No national HRM records kept on mobility therefore.

A smart public manager, Interviewee 22, a director-general realised recently that s/he has moved to and from within a ministry but no records attest to that as things are done arbitrary. S/he has therefore created a desk to manage mobility within the department (note not the entire ministry) within her/his jurisdictional silo. Silting background mobility data of the 32 civil servant participants gave a rich tapestry (Table 3 below) that has been left to chance as no conscious effort of national mobility management and for that matter no existing institution is located for that purpose in the system.

Table 3: Mobility Analysis in the Finnish Public Administration

Mobility in and across Institutions			
Names of Institutions	Ministry	22	42%
	Related Sector	8	16%
	More than one Ministry	10	19%
	EU & International	9	17%
	Private Sector	2	4%
	Third Sector	1	2%
	Total 32 officers	52 (cumulative frequency)	100%

All interviewees have worked over 10years. The OECD’s (2010) observation is consistent that poor mobility is Finnish or largely a Nordic and Finnish feature: Cumulatively, a chunk of 22 out of 32 officers or approximately 42 per cent of the dealt with have worked only in one Ministry for almost the whole of their working lives. More importantly to note is that only 2 officers, a deputy director and a permanent secretary were observed to have move

across 3 and 4 different ministries respectively; and are likely to have so much Vision 2012 envisioned need, broad view of government (OECD 2010). And, interestingly, one permanent secretary did serve briefly with a non-governmental organisation (NGO). NGOs and other civil society organisation (CSO) work under an umbrella organisation KEPA. Despite being sponsored by the Finnish Government/tax payer the Finnish Public Administration and Management literature is silent in this respect.

The 3 interviewees of Vision 2012 owners have the important but non-integrated part of the mobility story: while 2 have worked all time in the same ministry with some brief international/EU exposure; 1, the boss has the opportunity of at least 3; being local, national and international/EU. All these mobility had happened per chance to them. For this reason no need is seen although been south for as to how it should be organised for regular institutionalisation. Interestingly, they all admire and keep watching the Dutch and UK systems; note the study tour for best practices also covered these countries (MoF 2003). Personal/individual and group (recent Local Government hatch off from Ministry of Interior to Ministry of Finance) mobility in the system appear not understood and left to chance notwithstanding the claim of running an effective performance management (OECD 2010). The “black box” links between HRM and organisational performance (Boxall and Purcell 2008; 224), is not understood on mobility in this process.

These rich broad and multi knowledge and experiences across borders of sectors, departments and units of society as benefits of mobility are, therefore, scarce in the Finnish system. For example, Government Managers in Singapore are consciously planned, posted and rotated to and from the sectors: on entry to the Public, then to the Third, back and, to the Private; and, back to the Public; trained and educated while at the same time taking care of the professionals alongside (Jones 2002). A substance director-general with 65 experts working up to him/her recognises this missing item of Vision 2012: “And, of course, every expert cannot become a head of unit, not here, not there; and cannot have a director’s position anywhere; but how to improve the career and make it more attractive” (Interviewee 22). The Singaporean experience encourages moving not only within government but across all sectors. Jones would argue the Singaporean model leads to vibrant sectors with not very divergent national values and interests due to common understanding of the system; as such most civil servants take early retirement from the government sector into the other sectors; thereby making room for young potentials managers and professionals.

Off the table are 2 out of 4 interviewed from the private sector who did work for the civil service before the switch off; one had European exposure. The good Singaporean sectoral blend is observed to be unlike in the Finnish system where sectors do not mix up easily and consciously: "...if I am honest politicians and these kinds of thing [Vision 2012] don't fit together so good" (Interviewee 3). Although 2 out of the 4 interviewed from the private sector suggested a great mix but that is to the contrary and not absolute. However, approaching absoluteness is the cross over to politics from bureaucracy: No interviewee could cite any former bureaucrat in Finnish politics besides late President Kekkonen the former head of the now Public Management Department of the Ministry of Finance (Interviewee 29). As a result, both political and bureaucratic leadership speeches are scarce from the top (apart from the Second Minister's opening speeches of FLP and things of the sort). One of such abundant presidential speeches on the Singaporean leadership development front by the Prime Minister revealed his deputy prime minister to be a product of the leadership scheme (Loong 2009). The Vision 2012 reformers lacked the very core realities of their own model. Apart from its training and development role Sennett (2008) argues such mobility breaks routine boredom.

Another issue is that late 2007 the Ministry of Finance published *Guidelines for the Transfer of official within the Government system*. Instead of new thinking alongside the existing it merely reinvented existing tools as follows: State Civil Servants' Act (750/1994), With regard to the public official's obligation to observe secrecy, Section 17 of the Civil Servants' Act refers to the Act on the Openness of Government Activities, and other Acts. Act on the Openness of Government Activities (621/1999), Unfair Business Practices Act (1061/1978) and Section 44 of the State Civil Servants' Act, including agreement on the public official's salary during the period of non-availability.

Finding nothing 'new' and specific to Vision 2012 strategies and of Mobility attracted a contact for more information and understanding. The non-interviewed signatory was contacted for what is new and how the document connected the Vision. This official argues Vision 2012 has no links with this guidelines document as s/he emailed: "The document that you have attached [Vision 2012 policy document] has no linkage to this document". When pressed if he has dealt with the Vision document, the reply: "Yes, I have seen them sometimes but those are not part of my block". However, despite the no connection to the Vision, "work contracts" is found to be new s/he argued. How new are they from previous job acquired? Quoting Act 44, the distinction

made was that prior to the new document it was appointment rather than contracting. This was not really convincing at all. Perhaps, it is the fixed term contracting that differentiates the two (MoF 2003).

Furthermore, through telephone chat it was noted that the officer had moved from a different ministry to this present ministry; not undertaken any of FLP courses or perhaps not socialised with the Vision but authored this document to fulfil an implementation item. Also, as the chief pointed out subordinate are good at taking instruction from their bosses without questioning. One can conclude that this officer has completed an assignment without necessarily knowing and understanding what it is about. A good characteristic of expert and silo system; purely individualistic based; and excesses of turf protection (Caiden 1994); so understanding the assignment is not part of his/her block. This document, in a similar manner as the mother Vision 2012 is thrown out there to chance. Nobody is responsible or in-charge communication and facilitating it for implementation. It's simply the usual it is up to them model, the implementees to implement as due fit and necessary (MoF 2003).

Vision 2012 failed to analysed the realities but contend with poor ideas undergirding the reform (Minogue 2001) hence the inability to generate, advocate and rectify it (Loveless and Bozeman 1983) let alone communicate to convince decision-makers and colleagues for acceptance at any point in time. The vogues of the Vision are the FLP. It is observed to be the new path emerged/emerging from deviation as a result of the resistance or forces from all angles encountered at the apex. The program is clearly a middle management invention as a result of the apathy of the top (Mintzberg 2009; Meier and Hill 2007; Caiden 1994). Although the input is flawed, the lack of managerial skill for implementation (O'Tool 2003; Pettigrew, et al.) might have exacerbated the problem. The FLP as identified as a hanging program that lacks substance focus and is running against what its chiefs believe in, that is, practice and experiential learning. This has not been brought to bear on the system. For instance, it lacks common mind principle as the chiefs have failed to communicate with HAUS to draw the curriculum as well as dissemination. Also, it signifies poor inter organisational interaction and relationship and information gathering on the program (Loveless and Bozeman 1983).

Interviewee 14's biggest fear is precisely what FLP is doing. S/he does not like to create the French elitist model where new career class with a close system is built. His reason: "We are

not elites here; we are ordinary citizens; and we are helpers. So I think there is the big change between, for example, Germany or France. I think I will emphasize the words **civil servants, servants, servants of the public**". However, uncivil masters (Vedung 2002) have been visible in this analysis. But as observed to the contrary, it is being preached at HAUS that future leadership belong to the FLP. At least, one is found to believe her/his appointment as a director-general had something to do with participating in the program. Dr. Veijo Nivala of JTO filtered from the grape vine that HAUS is to monopolize public managers training by legislation; but has it got the capacity and should this happen in a fully market economy? Consistent to this study, Veijo thinks that Finnish politicians are not doing the talking expected of them. In addition, much as he observes the need for leadership development so does he resents the American macho model. Peter Drucker's model contrary to that of the OECD (2001) which runs parallel to most human resource books on succession planning, is spread the net wide and select the best, through rigour (Pfeffer 1997). The Drucker Development model sits well with this study.

4.7 Finding: The Manager and Managements are Not Commitment to Vision 2012 policy

It was almost a decade of Vision 2012 implementation before the OECD (2010) came up with its review of the systems state of affair that necessitated collective commitment of the leadership. Boxall and Purcell (2008), Taylor (2001), and Meyer and Allen (1997) demand strong attention to commitment management in change management and HRM policies and practices. From Meyer and Allen Three-component commitment model (summarised into affective – want to; continuance – need to; and, normative – ought to), possible explanations were established for the absence of collective commitment in the Finnish Public Administration leadership (OECD 2010). The matter for most top executives are more of continuance and normative: People are trapped into becoming committed and legitimised by factors such as poor general [intra and inter] mobility. Remarkably, the continuance or cost based commitment which is easily connectable to longevity is visible and top level pay and pension, bonuses and other perquisites (Caiden 1994). It is a comfort zone matter (Colvin 2008): But this is the comfort thing; if you are used to doing things in a special manner... and then to face, let say, in the last part of your career you face new challenges; they are a little bit uneasy (Interviewee 14).

Top level expert managers are therefore uneasy and unwilling for this change process. To wit, from 1991 Interviewee 22 had been a head of department in the Ministry. Not according to any known official plan but personal interest[*/value/will*] as told. S/he has shattered within the same ministry and between the courts. Concluding that “I think also in a relatively small country like ours we don’t have so many high positions; so if somebody in this group of this very professionals for a certain time, what after and where would he/she be put later on?” Glaringly are the interviewee’s resistance justifications: fear of Vision 2012 pooling system, lack of understand and its future direction which is never discussed and communicated by the reformers and politicians. Normatively as a fairly young officer frustration is the case with no new directions and opportunities. Such professional executives ought to hang on the system for their survival not due to affective commitment; particularly, with over 30 years of continuing service.

As a result of frustration and survival issue against fear of Vision 2012 some Ministerial leading positions have been taken out as “protectorates” to be left solely for the expert manager to continue with the status quo. This undermining process could not be verified from the reformers as the communication had stalled already. Another underminer of commitment moral is the NPM (Taylor 2001) hard run performance management and contracting practiced in the Finnish system cutting on numbers instead of developing capabilities (OECD 2010). Others such as professional commitment rather than public good and its insular culture (Sennett 2008; Riggs 1994; Lovelace and Bozeman 1983) resist collective commitment as “a kind of the easy self-defensive or the answer and criticism towards that kind of approach” (Interviewee 22).

Leadership is a collective commitment process of marrying top-down pressures and bottom-up concerns as well as to the purposive networks (Pettigrew, Ferlie and Mckee 1992; Rhodes 1997; 2006). But in this case it is fragmentation galore. Picking again on the opposite comments from the 2 core members of Vision 2012 strategic group and interpreted on generational differences of young and old respectively: “They are not committed to our programs” (Interviewee 6); the director-general implementer and beneficiary retorts, “No; it’s not binding. It’s not binding anymore” (Interviewee 7) (Finding 2.2). The latter’s comments as an older generation may spell memory sift between former collegialism and present day independence which is what the new generation is well aware of.

The OECD believes that and did later recommend it because they work better than the soft tools in Finnish Public Management (OECD 2009). Furthermore, an associate of the failed

bill contends considering the resistance of the civil servants the law was an option in that Finnish public administration is legalistic and belongs to that tradition which begun with the French (Interviewee 29). “We have been planning and planning; and, we try to implement it in 2006 by law. We made a proposal to the Parliament and it was kind of disaster because the Parliament didn’t accept the proposal”. This option failed to understand Bardach’s (1980) argument and Implementation Game Theory that even with the law enactment it is not enough a solution by itself: Game playing, massive resistance and unleashing of entropy deflecting policy goals or even stalling it await. Clearly, Simon’s willingness without rules and regulation for organisation success (Pfeffer 1997) has no room in the Finnish public administration organisation.

At the Justice Ministry: “How come you allowed this leadership bill to fail? [A]ctually, nobody was heard from Ministry of Justice, and, of course, during hearing [at Parliament] we gave our written opinion as far as I can remember. The most important topic then was the bill, the proper bill; and then there is, also, we are kind of guardians in constitutionalism here. We paid attention to whether it is in conformity with constitution and other laws of developments and other principles we have in this country and so on. So, mostly, we concentrated on that not on the other topics of leadership and so on”, retorted Interviewee 22. From another angle, the Parliamentary failure to sit on the bill rested on two unsatisfactory issues, namely, the mobility and the closed pool with no entry to outsiders according to the Focused Group Interviewees of Parliamentary Committee on Public Administration; while pointing to the very front page of the rejected bill (HE 245/2006 vp). This bounced bill, however, is a well-known issue to all interviewees unlike the original Vision 2012 (MoF 2002; 2003 Finnish and English versions respectively) policy document in both internet and hard copies. Note that the Justice Ministry was not in any way involved in the failed bill preparation. Suggesting the formal channel was once again probably circumvented. Such thinking is also visible in the quotation below but failed to connect up to the politics.

Back to the chief implementer: “What is next following your bounced bill? What we actually do I would like to tell you; at the moment, we have contact with certain persons in all ministries who are responsible for the administration in ministries. They are heads of administration or something like that because they are in a way key person when appointing new directors in the ministries or in the agencies. They are often lawyers; and, anyway, they know what formal decision you have to make and how to proceed. We have very good contact with those people. We meet every 2 months; I think and discuss all these new steps with them and listen to them. **But we don’t have that direct contact to, let say, not Ministers; they are politicians; and, not other heads of departments in ministries because they are too many. It is impossible to communicate with all of them**”. Note that the thoughts and discussions with this group have not been reflected or impacted on the discussion so far; assuming they are the best commitment ideas.

This thinking is total contradictory to the envisioned broad managerial skill and broad knowledge of government (OECD 2010; Pollitt 2003; MoF 2003) and, society as well as the very HRM strategy and goals that are being sought for and implemented. It also implies that access to leadership (Rokkan 1999), even among them at the top is problematic; and challenges bureaucratic rights (Simon 1997; Dunsire 1990), and office democracy. All together it is silo thinking and a demonstration of poor knowledge and skills in such a strategic management process. This missing link Boxall and Purcell (2008; 55) perceive as “critical goals and resource development to be a mix, impure, interactive process fraught with both intellectual and political difficulty”. One cannot therefore be blamed for non-commitment if one is not linked up to the Vision and its processes following the chief’s comment. Boxall and Purcell will challenge the chief’s own commitment knowing the task of communicating with and reaching all heads and ministers is unattainable. They see this in expectancy theory’s view of “impossible goals will frustrate rather than motivate” (Boxall and Purcell 2008; 192).

Further queries from the chief’s bolded sentences include administrative, structural and even myopic/siloic view for a Director-General at a ministry with national scope. Even in Helsinki not all heads of department in the ministries can be communicated with statement brings to the fore why all is happening in and around Helsinki and not beyond. The statement also shows how it all dribbles past the very target of the policy, senior civil servants challenging their right to decision rule. This new strategy seems not to go far enough but conforms to modern organisational perspectives; the chief implementer is tucked in his pigeon holed, silo-slab gridlock lacking the necessary information and linkages to communicate around (Mintzberg 2009; Hansen 2009).

It was noticed from the beginning of this analysis that the Education Ministry Management failed to find link to the Vision as reported in the last chapter. Yet the Administrative Director is in these bimonthly meetings. S/he failed to connect up the chief’s ‘thoughts and discussed’ to the management of his/her ministry. The only interview at the Ministry confirmed the regular bi-monthly meetings. A board member of Education and a Faculty member of JTO Management School and HAUS interviewed had no idea of Vision 2012. Therefore, his/her teaching at JPO and board contributions is neither guided by nor consistent with the Vision’s principles as a national vision.

Due to this new linkage announced by the chief implementer particular attention was since given to the administrators and the structure. It appears the chief implementer's newly found strategic link to the administrative managers is substance slighted and weak in the super expert culture lacking any influence: "we have very good administration in the ministry; they are very good in what they do, I think; but I mean none of them would get any respect from my experts" (Interviewee 16). Other interviewees including the chief recognise this assertion: "Well, there is very much appreciation on substance; at Ministry of Finance, people always think that the substance is the issue and administration, that is, something below the substance; so it is the values that we appreciate". As notice earlier their deliberations fail to filter into the individual management systems. Meaning as mere subjects with interest and powerless no matter their commitment level they have failed in their communication of Vision 2012 to their managements: players of both interest and significant power, context setter with power and minimal interest, and the crowd having both interest and power minimally (Bryson 2004; see pp. 105). This Eden and Ackermann's power-interest grid seems to explain the silo-slab gridlocks well. The comment that "**we don't have that direct contact to...**" is worthy of consideration as problem of the slighting and substance culture. To the "**heads ... they are too many. It is impossible to communicate with all of them**": Understanding this insular culture and with the requisite capability explains away how all are reachable.

The consequence of these forces are not far-fetched: Reforms and their success in Finland is determined by the personal interest of a minister (OECD 2009); so does the dictates of communication and commitment process of Vision 2012: "The biggest question is perhaps the horizontal mobility; how to do it. And I just had discussion with one permanent secretary in one ministry and his minister was interested. There is a vacancy in that ministry as a head of department; as director-general. And, they want to have a person who has been in at least three different organisations. So that was a good start. So when they are announcing that vacancy they will tell if you think you can come to this job you have to have work career in at least three organisations, minus the one vacancy. But anyway that can make the change to start. It doesn't start if we write papers, policy papers. Mobility is good. Nothing happens but those small actions; I like them". This least resistance path and chance adopted depending on individual personal interest, value and will is neither State Will (Olivecrona 1971) nor Public Interest and Public Value (Bozeman 2007; 2009; Lynn 2003). It is a failure to adapt the reform to the locality, a crafting skill (Sennett 2008); but falling prey to a personal interest. The system fails to be uniform and centralised with common committed cultural value but remains individualistic. Vision 2012 is implemented based on personal interest and chance far from

communication and collective commitment notwithstanding the well-advertised call for collective commitment at its website.

The Finnish public administration's collective commitment is challenged in both structural and governance processes. These preamble commitment types cannot be easily motivated to activate the will for apt learning for collectiveness. Vision 2012's commitment approach and the target group's aptness leave much to be desired. The preceding does suggest there is no any systematic instrument of leading, coordinating and managing behaviour for commitment. But commitment is a rational behaviour in which it is possible to induce an individual to do something and this behaviour cannot be attributed to some powerful external force such as a reward or sanction but the internal will (Pfeffer 1997). This value-willing process cannot be left to chance as the study literature demands knowing the generative and operative forces and their constructive and destructive power (Bozeman 2007; Olivecrona 1971). Vision 2012 tenure of contracting and fixed term is taken on face value leaving out the psychological aspects.

From Finding 2.2 it was established the core formulators of Vision 2012 will not understand their own work, be committed and act to implement anything. Nonetheless, 2 of them were on the pilot programs of the tenure contracting with apprehension. Even the external or extrinsic economic motivator of (Pfeffer 1997) performance pay has soured the already poor relationship between the expert and the generalist (OECD 2010). Analysis here, more importantly, show that managerial opportunities [extrinsic job security] are very limited in Finland; particularly, due to its non-sectoral crossing. As a result, survival and defensive mechanism explained by continuance (need to or cost) and normative (ought to) commitment take over. It may also explain the individualistic tendencies in management strengthening the insular culture and little or no room for collectiveness. What is obvious to this point from the practices is the dominance of the taken for granted face value of contracting and commitment over scarce and necessary affective commitment (want to) at the ministerial apex. Moreso, as it is not simply a phenomenon to know what people appreciate to elicit performance.

The theory of psychological contracting matters in the understanding of social and psychological processes. The theory implies that faith in the management process is something that needs to be developed over time between management and the employee

(Boxall and Purcell 2008). From these authors and others (example, Meyer and Allen 1997; Taylor 2001) these hierarchical processes seek higher trust, loyalty and fairness. Likewise, does this study suggest these same processes horizontally at the top (with 5 tiers from deputy director-general to the minister; see chapter IV) for the collective commitment of the management itself. This allows them to know, understand what the common values/interest and will are. The vetting of the processes of commitment for Vision 2012 found not any prepared plan and its communication and even to the extent of challenging the chief implementer's own commitment. Affective commitment and collective commitment process for gluing the management are missing in the processes.

4.8 Conclusion

Post NPM joined-up-government or governance processes would require active participation and discursive communication of all participants and stakeholders in the implementation process. This enhances collective commitment and progress. In this vain, this fourth section of the analysis has dealt with finding out the Implementation Communication conduit material and how it had been understood, packaged and communicated to the target groups and relevant implementation networks. No Implementation Communication plan is sighted; making systematic tracing paths of possible communication for implementation backwards or holographically more challenging. Vision 2012's own implementation plan played key role in this process to locate the reform core value-wills that remain cold and non-explored including communication for action. The four conduit material of implementation properties, namely, understanding, willing, capability and culture were explore one after the other and integratively; revealing no commitment to Vision 2012. The analysis also led to a new finding alleging the Finish Public Administration is run base on management by objectives. This was traced to reveal theoretically it could be correct as two interviewees attested to it importation but far from practice as observed of its silos and communication difficulties. All these finding evidence demonstrate poor understanding of the issues, poor manager extraction capability and poor communication. The processes of the reform are better described as taken for granted or a face value.

Vision 2012 and the super silo culture are not understood by its own owners who also dubs as change agents. They have never met at any point in time to retreat on it with the formulators or any other relevant group to share ideas for understanding purposes. This means right at

start the reformers failed to understand and grasp the complexities of value-will, communication and cultural issues of the reform ideas. The instrumental and intrinsic values of the core elements remain unknown. Hence political will, support and communications are not forth coming. Issues of capabilities and communication are unidentified. Competency curricula are not discussed and undeveloped with stakeholder or even initiated; as a result no new capabilities and skills are developed. The cultural weaknesses and strength have not been thought of, let alone, tackled. The operationalization of the Vision for implementation remains problematic from all angles.

The Finnish Public Administration is a super expert system and substance, therefore, matters. The resulting insular culture slights and resents the 'non-substance' groups. This insular culture further challenges the MBO communication processes. Again, the reformers are found to belong to the resented weak grouping with no power and poor capabilities including free and open communication. Informality prevails. Individual interest dominates public's and with low to nil collective commitment to the vision. The public, private and third sectors fail to mix and blend; thereby, providing narrow managerial opportunities and defensive mechanisms that frustrate management collective commitment. Tensions abound in the system. The networks of dealings show nothing futuristic about the managerial leadership. This raise questions about direction of Vision 2012.

5.0 Theory Tests

5.1: The Brunssen and Olsen models

Firstly: Brunssen and Olsen's first model of throwing the reform policy out there to implementers without any further contact with the reformers after its introduction (which was resisted in this case according to Interview 6 making them bow to the pressure). It is the "it is up to them" model of implementation observed in Government/Ministry of Finance's literature. Perhaps, with the assumption that the expert "knows it all" and, so knows what to do (chief implementer; interviewee 15); in that perspective, no true goal oriented results are observable on that point of view besides the massive resistance and outpouring of entropy stifling or killing the program and its goals (Bardach 1980).

In their other model Vision 2012's implementation suggests Finnish top managers implementation skills remain in the **past** (see Figure 9, pp. 109; Brunssen and Olsen 1993) for refusing to call for assistance, keeping to their business and protecting their turfs among others. From the analyses the Finnish manager's egotism, rivalry, fear and so on are strong enough to encourage no implementation goes on not even from the lucky chosen formulators.

5.2 Hasenfeld and Brok's modified theory

Secondly: From Hasenfeld and Brock's modified theory, pitching the input of Vision 2012 to the powers in the system suggests a **low to nil** correspondence indexes in cell 4 (see page 127). Implying that there has been poor or no communication in a highly fragmented system and poorly coordinated to yield any meaningful results. To the opposite cell 1, the expectation should have been concentrating power to mean greater commitment to a program and its mobilizations that will leads to greater results; thus structure and processes aligned.

5.3 Value-Will Management Development Model

Thirdly: The preferred economic incentive or performance pay was found to have polarised the system (OECD 2010). No development of capability and values system found pertaining to the Vision implementation. From both literature and data the system's forces including

regulatory capture theory did manage to keep the Vision in the administration's **comfort zone** (Colvin 2008) as the Permanent Under-Secretary observes and they continue to do what they know best. In other words it is also interpreted as laissez-faire approach of avoiding responsibility and leadership (Bass and Riggio 2006) by both the reformers and government managers. However, the transactional reward leadership (Bass and Riggio 2006) attempt of the reformers was observed from the OECD (2010) 'disputed' performance pay. It is more of arbitrary than appraisal approval performance.

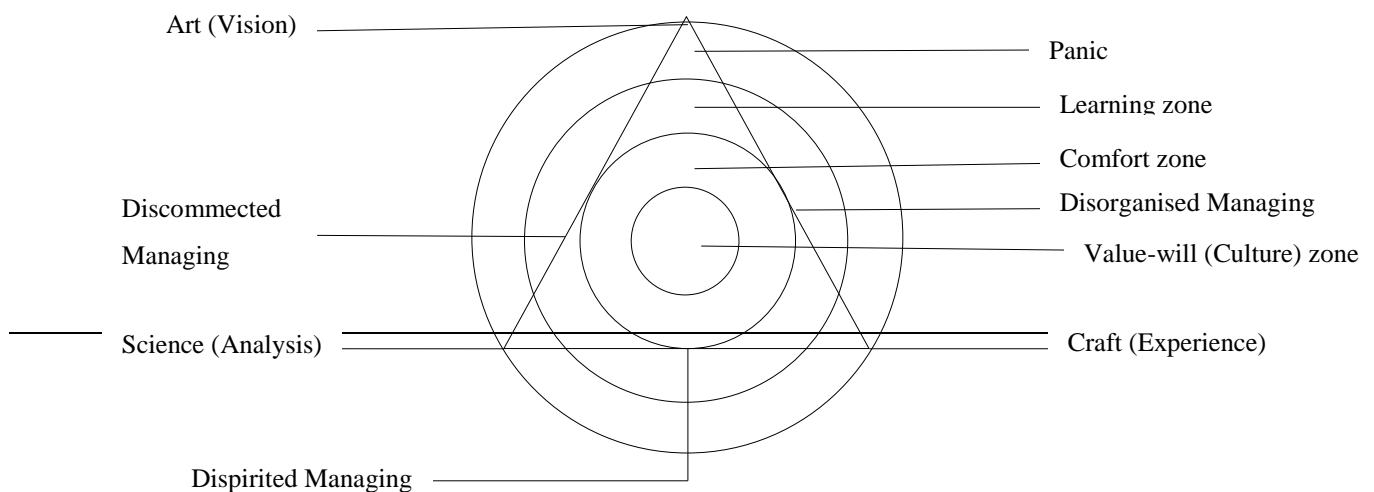

Figure 15: Proposed Value-Will Management Development Model for crafting imbedded in culture plane

Such a situation from the literature accounted for and promotes disconnected managing, disorganised managing and dispirited managing (Mintzberg 2009), between the manager and the expert, of course the politician too. This study of the comfort zone hostility permits not free open communication, generally and implementation communication, particularly. Consequently, distorting and thwarting practice toward crafting, structuring and institutionalising for nation building. Hence the proposed Value-Will Management Development model for a possible way out of the non-progressive comforts zones. It is internal forces of the people complemented by the external that are more probable to provide the solution.

This crafting development model is universal and multi-purposed. This is based on the idea that crafting belongs to any domain. It, therefore, is possible to serve the balanced scheme of the manager and professional development. It takes care of the bureaucratic excesses (Caiden

1994) and balances (Lynn 2003) of the basic individual/group drivers/motivators. As Sennett notes the trouble with craftsman's quest for quality is obsession and that can lead to isolation and loss of community as Plato identified above; but the craftsman thinks and must communicate on the work-purpose especially with the community; craftsmanship require time, reflective thinking and intuitive knowledge; as well, craftsmanship finds a home in pragmatism. In the wish of the proposed model it centres ethical values (aligning individual and organisational) and free will to curb obsession and ubiquitous motives of both the manager and the professional in crafting.

It combines with the properties of implementation to work pragmatically thus theory and regular practice well communicated. And, its philosophy is to think locally and act universally, and systematically. The model unlocks the 'black box' problem of HRM links to organisational strategies and performance (Boxall and Purcell 2008; 215). Therefore, making it compatible with appraisal systems so does it care about reform design and formulation as well as its implementation communication strategy for better alignment.

5.4 Theory of the Silo

Taking it off and to the end from where the OECD (2010) left off sweeping the silo issue under the carpet revealed the insular culture of such as system: obsessed or poor capability, fear, poor communication and lack of understanding of how these impacts on the individual as well as the organisation. Mintzberg (2009; see also Hansen 2009) observes modern day managers tucked in these silo-slabs starved of the necessary communication and ingredients for action. It is also possible to posit yet another: *theory of silo* deduced from the analysis bearing on the myopic thoughts, actions, comments and conclusions observed that failed to progress the reform beyond comfort zones for any meaningful development as well challenges office democracy and, the governance process as a whole. Both the individual manager and institutional extraction capability remain limited and poor. This is modeled to be synonymous **to a tight pack of capillary tubes tucked in a pipeline cemented by grey matter requiring major value-will reformation.**

VIII Discussion and Conclusion

1. Discussion

Democracy and governance have bureaucracy as its tool (Kovan 1994) for implementation. It incorporates the new perspectives of nation state building through crafting, structuring and institutionalisation (Lynn 2003), through the processes of building new and repairing existing institutions (Fukuyama 2005). This is evident from the European classical time of military-administrative, economic, culture, and the recent shift towards identity construction, participation and mass politics (Rokkan 1999). Through all these models runs communication the mode of influence that this study has recognised necessary for any meaningful crafting, structural and institutional development. Classically, argument for this need suggests that voice cannot be studied without the internal barriers to communication involving boundary reduction and boundary building in this mass process (Rokkan 1999).

The study is back to where it started from (chapter II) to acknowledge the ‘separation of powers’ at the ministerial top, individualisms, and poor communication (OECD 2009; 2010). It is truly super expert system froth with tension at the top that frustrates the already weak communication culture. In such an expert culture horizontality will always be a reform factor to contend with and driven away from the joined-up government (JUG) or governance processes. This is synonymous to the knowledge that the quality of a leader depends on the quality of the advisors (Fukuyama 2005). This need officially identified a decade ago as *Towards Professional Management in Central Government: A Strategy for Management Development 2002-2012/Ammattimaiseen Johtamiseen Valtionhallinnossa: Johdon Kehittämisen Strategia 2002-2012*; Vision 2012, so dubbed for this study, due to its ultimate goal over a decade: For a smart responsive, flexible and broad viewed government manager in a centralised managerial pool of common culture for government; readily accessed and fixed contracted, and appraised for further managerial challenges or dropped off for non-performance.

The non-existent Communication and Implementation Communication are used to assess the decade (2002-2012) long implementation process of the Vision. To the question of achievements/outputs and outcomes the Chief Implementer responded: 1. successfully

negotiated for new emoluments. This is an NPM/HRM individual performance pay and economic values (Brown 2008; Reichard/PUMA 2002; Taylor 2001) and external force (Pfeffer 1997); 2. Bringing together for the first time all the 140 top government managers in the country; 3. Piloting contracts agreements and, of course, 4. The 'deviated' Future Leaders Program. "What of a rough grading of the whole program successes? May be on two; from zero to ten [scale], two or three, so far!" For emphasis sake: "So far? So far!!! But "the big question is perhaps the horizontal mobility; how to do it." And, consistent with Interviewee 14, perhaps, the key owner thinks that "Sometimes I lack the resources and ideas". These comments are a mirror reflects of the implementation process analyses and syntheses. Evidently, the reformers lack of ideas was observed to be consistent with the problematic operationalization processes and the failure to identify and carry through with their original idea. Furthermore, it was noticed that even those who are aware of Vision 2012 have no usage, no commitment. And, no championship or sponsorship (Bryson 2004) for any aspect of the implementation processes found from the political, or any of the sectors; but games of goal stall or deviation abound (Bardach 1982).

For better understanding and consistency the process of analysis has followed a funnel-like pattern from the source design and formulators small group through the Ministry of Finance and finally, to the entire system plethora of implementers of the ministerial top management. This top government ministerial apex leadership is responsible for the leading roles of the Finnish system while the Parliamentary leadership plays a watch dog of its bills, statements and possible trouble shooting. It is simply from narrow to broad level seeking for understanding, communication and the subsequent actions and inactions of this leadership. By this funnel-like strategy analyses certain consistent patterns emerge that includes non-action based on non-understanding from the formulators through the Finance Ministry/owners to the entire system and the difficulty of operationalization. These further led to the data sources falling into two categories of four groups that inform of some reasonable order although not mutually exclusive. It follows: 1) On Vision 2012, its data [mainly history and information] came from the (a) formulators and designers; (b) the owners and (c) the HAUS graduates (recently appointed director-generals and below) told of the Future Leaders Program/Vision 2012. 2) (d) The last category was the director generals and permanent secretaries [already in position before or soon after the Vision's inception] providing mostly the data on nature of the top most level.

These demonstrate the divisions, subordination and extent of dissemination and integration of the Senior Civil Servants Vision and Strategies among different generational as well as hierarchical actors. It also tells how it has been and continues to be accepted or rejected. The study establishes neither the reformers did provide nor the reformees (particularly, the category 2(d) noted above) had received any of its training on the Vision; even the 2009 all government top leadership conference failed to connect up the knots to the vision. Therefore, the top corps of the ministerial management remains the same without any infusion from elsewhere although Vision 2012 and NPM advocate for change from policy to pragmatic manager. Interviewee 10 argues that it may happen after their “generation is gone”; as well taking note that could be difficult to attain because of “lack of ministerial” or “government insight”. This hints on the neglected future and its educational curriculum material.

The Finnish Public Administration is examined to be broadly an expert system and based on expertise rather than an integrated management and administration reflecting anything of Hood’s Perfect Administration theory (Younus and Davidson 1990) and Drucker’s (2008) Management by Objectives: that aligns people, resource availability, political acceptability and perfect communication and coordination amongst all the administrative units. In this manner managers at all levels grasp and are of common minds of the needed principles for action. In particular, Findings 4.1 and 4.3 accounts more for the rare politics-administration mix and the non-sector mixes; as well as the structural analysis of the Finnish phenomenon’s (OECD 2009) poor synergy construction even among civil servants. Singapore (Jones 2002) and France (Rouban 1997) have both centralisation and great mixes and blends of sectors and professions especially for the former.

Furthermore, in the data “substance”, “management/leader” and “expert” were the most competing and antagonistic words. Perhaps, these driving forces supported by the literature and empirical findings such as poor communication, poor manager/professional development and poor social pressure management, political apathy to reforms and, of course, management incompetence have moved the Administration towards the silo systems position of the opposite end of Hood’s Perfect Administration theory/Drucker MBO; thus Caiden’s J-Curve of excesses: The Parliamentary Focus Group Interview noticed with time most experts have grown into leaders of their department and sectors without the capability and understanding of leading and managing people. The Finnish traditional preference for expert to generalist (OECD 2010) [might have been taken too far]; experts are obsessed with their

profession (Sennett 2008; Fukuyama 2005; Lynn 2003); that the expert does not want to be led and their leadership results with insular culture (OECD 2010; Schein 2004; Sennett 2008; Riggs 1994). In addition, it slights others such as the generalists and politics based on non-substance and incompetence. More importantly, it is traditional ownership that stands up to expertise; this tool, for example, blocks the management theory base of Vision 2012 for understanding and focus for both the policy and implementation.

In traditional Weberian bureaucracy promotions have been longevity and seniority based in the public service generally rather than NPM performance base (Brown 2008). Appraisals are neglected in this case in point, Vision 2012 implementation. A more recently Government document (MoF 2011; 1) puts emphasis on what the Vision has failed to seek and develop of a silo-culture solutions; but to the contrast demanding it “leadership and executive management skills” as the selection criteria for Central Government top posts. Evidenced from this publication contents of selection criteria and this study finding demonstrate non-systematic, non-uniform and central appraisal based but more of individual and personal interest based for Cabinet approval. Thus corroborating on-going reforms strengthen the status quo (OECD 2010).

The senior generation of experts noted above spoke neither of Vision 2012 nor do they attend any more training since the 1990s. As one interviewee puts it that s/he was at the end point of the civil service and about to cross into the political zone where they were above training and development. Clearly, it is a case of the expert going above their authority by their science (Lynn 2003); and owing allegiance to their craft/profession/organisation rather than the community and common good (Sennett 2008; Fukuyama 2005; Koven 1994; Lovelace and Bozeman 1983).

“Never have the expert leadership been challenged in Finland”, observed the Parliamentary Committee Focus Group but for Vision 2012. However, the expert factor remains silent in the Vision documents or never voiced out in the implementation processes. It might have been taken for granted or not recognised at all or recognised but due to the tension, slighting and weak position of the reformers although a key issue to contend with at both individual and institutional Management Development levels (Drucker 2008; Sennett 2008; Lynn 2005; Lovelace and Bozeman 1983). The absurdity is whose responsible it is to develop the experts

in the system if that of the manager is to the Government as Employer; and where do the two align?

Interestingly, some heads of the civil service in their attempt to be responsive to their political elites (Halligan 2003) and generally, the administrator may also deviate to go along with the regular elites by doing away with democratic principles (Koven 1994). Putting behind their baggage in this case, it was noticed the administrator and expert together as civil servants accuse the politician for fear of their better capability hence the lack of or poor support for Vision 2012 and its implementation. It is hard to accept this accession verbatim although the Parliamentary group interviewed did not exonerate the politician from this insular culture development. Other factors abound (See Finding 4.4).

But as it was found, communication of the policy never got nation-wide coverage or even well established in the capital at any point in time. Moreover, the analyses also pointed to no systematic and consistent facility for management and leadership development in the entire system but for the ad hoc and, modular runners (Pollitt 2003) and for MBAs (Mintzberg 2009) that may have little or no relevance to government and governance processes. Poor to no evidence of lifelong learning developments of the leadership (Yukl 2010; Hackman and Johnson 2009) is observed from Vision 2012 failure to understand and pursue the development of (national) curriculum on its model core value-“will to lead and develop” (MoF 2003; 16). Figure 14 (pp. 182) systematically illustrates this phenomenon clearly in analysing government reform and the role of the change agents non-visible and non-functional. Thus a bounded top management not getting things done due to poor communication for capability, understanding and value-wills in a government set up.

Good governance values includes participatory, consensus, accountable, transparent, responsive, effective and efficient, equitable and inclusive and follows the rule of law (Sheng 2011). Sheng also observes it is also responsive to the present and future needs of society. The European Union level values noted earlier are openness, participation, accountability, effectiveness and coherence with the assumption that a “more coherent Union will be stronger at home and a better leader in the world” (EC 2001; 1). The Nokia values, Nokia Code of Conduct, and Investing in People (IIP) at Nokia with Both the human resource department and top line managers deeply and actively involved including the chief executive led to the organisation’s success (Hakkarainen 2009). Such practices are not observed in this

study. Again, the study model's 10 core values as follows: trust, efficiency, quality, impartiality, independence, accountability, expertise, service mindedness, transparency and sense of responsibility (MoF 2003; State Civil Servants Act 750/94) remain contradictory to even Vision 2012's own shared envisioned culture. Comparing the classical precepts of management (Bertelli and Lynn 2001 in Lynn 2003) - accountability, judgment, balance and rationality - to Vision 2012 values and the others cited raise both quantitative and qualitative questions on the State Civil Servants Act 750/94 (Valtion virkamieslaki 1994/750). Besides being self-conflicting they fail to synchronise with the EU and good governances'. A review for precise Finnish precepts of Management based on society needs, interests and values is a necessity.

The study finds and acknowledges economic individualism (Bozeman 2007) drawing conflict between traditional and economic values (Ikola-Norrbacka and Jokipii 2010; Bozeman 2007) posing a challenge to the "new" Finn and the changing mentality (Finnish Literature Society 1997). The awareness and recognition of such differential generational [individual/public] values/interests at the core of nation building and its management development becomes necessary for a balanced direction. Emphasis is, therefore, placed on Meier and Hill's (2005) determinant element of the failure of the elected official to set the pace and nurturing the requisite connecting value[-wills] i) for the bureaucrat manager, that is, between them; and, ii) among the politico-administrator-governed. The principle of "national development strategies based on assessments of need and capacity, combined with strong national leadership are the basis for successful development that strengthens the rule of law, and that such national ownership is a prerequisite for sustainable human development" (UNDP 2010; 1).

The very much desired ethical managerial leadership craft or charisma (Mintzberg 2009; Bass and Raggio 2006; Sennett 2008; Shafritz and Russell 2003; Selznick 1957) imbued with values, particularly, wills are rare. John Bonner (1986; 6) argues that rather than the betterment of society or the individual, welfare should be judged by deserving; this determines the well-being of society "because they more closely satisfy a system of natural law, a moral code or because they obey the Commandments of the Almighty". The public manager must have both political and intellectual skills (Boxall and Purcell 2008; Lovelace and Bozeman 1983); but other literature (Bower and Weinberg 1988; Pfeffer 1972) has taken for granted that public managers unlike their private sector counterparts possess political

skills automatically. This automation is false: In a decade of implementation, Vision 2012 failed to acquire political will, support and communication for its processes. This questions the qualitative capability of the lead administrative reform institution of the Ministry of Finance (Temmes 2004).

The political aloofness is too obvious to this point. Both the Presidency and Prime Minister's Office are distorted structurally and weak. Political leadership speeches on management and leadership developments are rare. The President (constitutionally appoints and promotes top government managers), Prime Minister, other individual politician including the Second Minister of Finance directly associated with Vision 2012 policy contacted will not grant this study an interview. Tiili observes it is politics over management as "no evidence was found to overrule this general statement by Pollitt and Bouckaert (2004, 156) [that] 'There is an absence of evidence concerning the willingness or ability of executive politicians to become the 'strategic managers' of their portfolios'" (Tiili 2008; 130). This finding sets a management dichotomy and passivity befitting an interviewee's description of the very top as having their "hands off the management". In this light, more is revealed of the distorted structural politico-bureaucratic interface; and, along this line, the Finnish Presidency is severed from the rest of the public administration system to support and ferment any constitutionally prescribed centralised government (Finnish Constitution 1999/2007; MoF 2003; see chapter IV) and any unity of purpose leadership development process. A suggestion to enlarge and strengthen the Prime Minister's Office to enable it coordinate the ministerial functions is offered.

The OECDs (2010) other point of coordination in the system, namely, the Ministry of Finance was found not to be so, at least with Vision 2012 (see Finding 3.3). At the lead agency of the Ministry of Finance, for instance, it was observed that nobody is interesting him/herself with the leadership substance; that is, "only doing what nobody else does. Trying to gather all the issues and looking at how they fit together and how they should sort of fit together better. Nobody is doing that. It's done every 4 years in the government program but that is not enough". No linkage was also found to any political office. Note that the government program evaluation is self-reported (OECD 2010). Although evaluation is a regular exercise (Pollitt and Bouckaert 2004) as have been done for the so-labelled FLP (MoF 2011) there is lack of monitoring and, evaluation utilization (Pollitt and Bouckaert 2004; Patton 2002).

Even more complicated are the **sensitivity and non-discursive nature** of the Finnish managerial leadership but merely played “silently but rough”; warranting hard tools for effectiveness (OECD 2009; 2010). Vision 2012 failed bill (HE 245/2006) was to solicit this tool for its implementation; perhaps, as the last resort against the resistances and non-cooperation of other managers and experts [and, to the politician and the governed?] Obviously not the solution as new set of games and entropy emission ensue following the law enactment (Bardach 1980). This sensitivity and silence are exacerbated on the one hand; to the other, it fails to be consistent with democracy or mass politics and voice (Rokkan 1999), governance and management values that Habermas (1986; 2008) assert to be discursive.

For the bureaucracy-democracy debate to be on-going; and, taking it from classical theorists (Weber 1974; Mosca 1939; Michel 1915) point of view, Koven illuminates the inherent tension between bureaucratic and democratic values and principles: while bureaucratic assumptions emphasises hierarchy, chain of command and a top-down approach to problem solving; democratic values necessitate inputs from all stratum of society as a guide to proper function; and, these are necessary for their harmonious co-existence (Koven 1994; 92-3). And, for good governance promotion and effective management: Governance process is based on discursive communication (Habermas 1984; 2008) and the chief tool for managerial and business leadership (Yukl 2010; Mintzberg 2009, 1979; Hackman and Johnson 2009; Brunson 2008; Simon 1997; Selznick 1957). Open and direct Communication, the necessary basic managerial tool is found missing in this study. From the fore discussions comes the question on the reformers/change agents’ activism role and understanding of the definition of reform as deliberate change (Pollitt and Bouckaert 2004; see pp. 123) and its necessity (Kickert 1997).

Intentions are to match activism (Bozeman 2007). Good intention is not an excuse for non-performance (Drucker 2008). Such intentions and activism as noticed already of European Monarchs have resulted into today’s public spheres. One such intention statement is that “Everything exist for the state; this word contains everything, so all who live in it should come together to promote its interests” and owner activism (Blanning 2002; 340). This is consistent with the System Resource Model (Nigro 1983): That all human organisations are open systems that must continuously transact with their environment for survival. Nigro argues that external extraction capability from the organisation-environment relationships is a

plane with different strategies used for convincing outsiders for political support, finance, and other resources on regular basis. Strong Communication and information management ties with the external system facilitate innovation (Loveless and Bozeman 1983). Amidst this background are the following of Vision 2012's attempts at innovation in a super silo culture:

- The reform input is flawed in content and methodology; as it did not incorporate its environment;
- The input lacks theory and Implementation Communication plan;
- Weak ownership, poor perception at reform home and questionable qualitative capability of the lead agency;
- The reform core values are challenged for both quality and quantity, alignment and consistency with the broad environmental values and interests;
- The piloting of the fixed contract assignments is tensed and not appraisal based;
- Formal communication and coordination for coherence is absent in the system;
- The reform is deviated and fizzled out into future leaders program (FLP) while still avoiding the true future leaders although so-called. and,
- Finally, and not the least, but perhaps the most difficult is the operationalization

Following these observations and findings of the implementation evaluation, it is plausible to accept the OECD (2010) standing tall silos despite failure to further seek the causes and effects; but reject the ambiguous report of the Ministry of Finance's (2011; 57-61) assessment results of the FLP (Tulevaisuuden johtajat - valtion johtaja – politiikan). FLP is not the original Senior Civil Servant Vision 2012. It is a deviated version. The deviated modular FLP is a middle level invention as the bosses look away (Caiden 1994; Mintzberg 2009). However, by hermeneutics/Constructivists principles it is considered another version of the same context and at the same timing but interpreted from a different point of view. Importantly, and, similar to the original vision the report's 25 recommendations still recognises the apex and top middle managers as future leaders rather than the primary true future leader, the young and unborn. The paucity of literature (Examples Finnish Literature Society, Finnish Cultural Foundation), therefore, calls for the interpretation of the Finnish concept of 'future leader'.

Management Development is about the future, its needs and demography (Drucker (2008). The public managerial leadership development models such as the Chinese Mandarin process

(Riggs 1994), and the Ottoman-Turkish model (Heper 1994) have been bottom-up development approach. Riggs argued political resistance (and to a large extent failure of implementation) led to the hybrid senior executive services (SES), an extract of outstanding professionals which is not about future leading. In this study, the approach is none of the above and lacks clarity with any outstanding output/outcome model description. However, the policy document beams onto the middle top. Practically, amidst the political apathy and expert resistance the middle becomes the obvious target emitting the output: the FLP. The bottom, the nation community and the very future are totally cut off completely from all the processes perused in the study.

Above all, **the core value-wills** are missing totally from both the reports and processes investigated. It implies a neglect of its own original ideas. Reform ideas in a vision are adaptable (Behn 1991) or best practices (Fukuyama 2005) are not easily transferable due to context. Or, simply it is forgotten as this is typical of reforms (Brunssen and Oslen 1993). They are both cultural futures but not understood hence the slippage. Also, there is no communication plan and no Implementation Communication. Considering Fukuyama's ideas of change the reform did not impact on education, leadership and societal interaction leaving the silos tall in standing ten years of implementation of Vision 2012. The Parliamentary Public Administration Committee's FGI recognises that "the civil servants in their palaces and if you are going to educate them to new ideas it takes time; and, perhaps, it takes new civil servants in the leading places when the old ones are retiring". This important recognition has not been an observable happenstance as the problem is poorly defined and understood.

2. Grand Conclusion

Going by *Towards Professional Management in Central Government* policy the Finnish Public Administration is in transition since 2002 to 2012 from believe in super expert rule with insular culture to match the new governance or JUG system. The focus of the study had been how the core of the reform values backed "will to lead and develop" the 'professional' manager had been communicated over the last decade. It reveals characteristics such as frustrating free and open communication; promotes individualism over public values, public interests and public will. As a result, it causes the obsession of the expert going over his/her science to the detriment of the nation community. The obsessed exhibits the inability to understand themselves, their own behaviour and those of others including the community.

They resist control and refuse to play second fiddles. As managers they are mostly poor leaders and resist collaborators as a result of misinterpretation and misunderstanding of the [managerial] job with the continuance specialism attitudes. They know it all and nobody tells them what to do; and, they issue out orders to be obeyed without resistance. Longevity, seniority and immobility add to the management weakness as more of the insular culture is explained.

Furthermore, there is slighting of politicians and other 'non-substance' bureaucrats. Together, the bureaucrats go at the politician for management inexperience. Age or generational gap and experience are other factors. Together, these elements split the top management into three different groupings: the politician/minister, the expert and the generalist. In such silo or pipelines system, trust and honesty are the most value-will that seems to be holding the system together is found consistent with earlier studies. This has been enough to retain the people in their individual comfort and organisational comfort zones. The zones are further viewed as tied by formality but operate purely on informal bases. It is problematic connecting the two. Consequently, the silos are tensed up and challenges office democracy.

The political and administrative classes fail to understand the insular culture and to take control [coerce, negotiate, bargain] of the fragmented top that is also separated from the bottom and the rest of the system. Leaving the latter alone in the cold the former finds a home in the Parliamentary Government and Parliament where they belong. Hard tools to support their ministerial rule are acquired from there. This option obviously had attracted the weak generalist reformers. But unfortunately an attempt at it ended in a fiasco and a consistent failing to cling at political support and will. Their weak positioned Second Minister of Finance – Public Administration and Local Government – whose jurisdiction the Vision falls failed to take the message to the ministerial colleagues neither horizontally nor vertically to the president and down to the Finnish people. Consequently, Vision 2012 had been churning out documents and acting more informally without the necessary capability, political skill and clout for formalization. It suffers from legitimacy and traditional charisma.

Considering the fore issues credit goes to the NPM reforms for bringing to the fore government manager development, performance management and appraising. These reforms have ushered in this transition to governance processes a decade ago. Despite being a recognised long time national need, at least, at the top; challenging Finnish Public Management Development with Leadership as a sensitive subject; thereby fails to be the

political priority but a few administrative civil servants' "imposition". From the study, leaders are expected to do what nobody is doing as of now: possessing broad knowledge and view of government; trying to gather all the issues under their jurisdiction and looking at how they fit together and how they should sort of fit together better; discuss, negotiate, dialogue and coerce where necessary, and together with their subordinates choose and move to the desired direction. So wholistic too is Management Development and its approach. Defining the public manager must be characterised by the individual and the (nation) community needs, values, wills and relationships in broad perspectives. The fore revelations tell the manager cannot be developed in isolation and the context of the reform is even critical. Indeed, notwithstanding these difficulties, Vision 2012 by definition is an invention of the Finnish Public Administration.

However, the study notes all the three fragmentary groups of the top management consent to the need of Finnish management Development but the processes and actions run to the contra: no individual or collective commitment at any point. This manager development has not been well sold or bought into as the reformers failed to understand their own culture and the needed political culture and other ingredients for the change. It is an isolated management development case and far under-estimated both on paper and in reality with barely a non-existent network of implementers. Perhaps, it is as a result of the tension of "know it all" that ushers in its correspondent "it's up to them" implementation model. In this vain things are observed to be taken for granted and left to chance and nobody's responsibility for the six (6) set strategies. These contradict the definitional deliberation at change. The reform owners themselves, for instance, fail to establish the only non-paper practical would-be hub or coordination unit of government managerial pool.

Tension mounts as the institutionalization of the "successes" such as the FLP, and piloting with fixed term and contracts persist since 2009. Glaring conflicts and rivalry failed to be acknowledged and resolved leaving the structure polarized and personalized. No national curricula and education, or service providers or even the exact target is known of the so-called future leader. Consequently, the Finnish Government Manager remains non-transformed manager as their fellow European public managers notwithstanding the two decades of NPM and reforms generally, and particularly, a decade of Vision 2012. This chasm and practices diverge from the present post NPM JUG. Therefore, Vision 2012 is at innovation attempt.

Policy quality and operationalization difficulty or the lack of communication plan and active communication are to blame. Also, the failure to consider and understand own culture and to identify the individual Finn's level of cooperation, commitment and action but jumping to corporate level is absolutely a structure without foundation. This study perceives collaboration/cooperation and commitment for action to the Finn to mean weakness and failure following the barriers to implementation and development in expert culture analysis. This expert insular culture is described "super" to this study due to the fact that its silos or pipelines are not easily amendable and or amenable. This means the sectors – public, private/business and the third – follow this expertise lines and fail to mix and blend for any meaningful fertilization of the system and for manager development. The sterilized ends fail to create quality managerial positions and personnel.

By this observation and reasoning, it affects both qualitative and quantitative developments. Managerial positions are limited in the line areas and even rare across lines. Chiefly, to the Finnish public manager, and probably to all others this is about the individual's survival more than any other factor. In addition to this manager's woe, Finnish traditional ownership, reform home, and leadership by example need to be seen as key factors that could affect policy and implementation positively; or negatively as applied in this study. These culminate in Vision 2012 poor and weak deterministic approach and its subsequent rejection by both the politician and the expert while the governed knows not what is going on.

The need, thence, is to first seek the individual manager's [be it administrator, professional/expert and, of course, the political master] level of collaboration, commitment and action. This establishes the beginning and direction for common mind principle practice, a move towards effective governance. The framework or the theoretical models: Analysing Government reform idea by common minds principle of communication and Value-Will Management Development hold the necessary suggestive views for both management policy development and implementation with broad scope. The framework is constructed from nation building historical/practical and theoretical bases of crafting, structure and institutionalism to arrive at this methodological **standard of Implementation Communication** to develop and enhance active communication strategy for implementation and management development.

A further investigation into the nature of the Finn as an effective manager of public interests, public values; and public will – as an institutional leader or craftsman – are the necessary

prerequisites for good governance and development; but not without the consideration of the expert and the total environmental stakeholders for leadership is a (nation) community entity. Furthermore, whereas the lack of repository for civil service affects management development; the Finnish Public Administration and its precepts of management leaves much to be desired. They require further studies. An open and free direct communication strategy with Implementation Communication as its conduit material standard tool is a need for that matter, particularly, for unity of purpose process.

Reference

- Aaltonen, P. and Ikävalko, H. (2002). Implementing Strategies Successfully. *Integrated Manufacturing Systems*, 13(6), 415-418. Retrieved from <http://www.emeraldinsight.com>. doi: 0957-6061.htm.
- Aarrevaara, T. (1999). *Restructuring Civil Service in Russian Public Administration* (Report No. 17/99). Helsinki: Department of Public Management, Ministry of Finance.
- Al-Ghamdi, S. M. (1998). Obstacles to Successful Implementation of Strategic Decisions: the British Experience. *European Business Review*, Vol. 98; 322-327.
- Alho, O., Hawkins, H. & Vallisaari, P. (Eds.). (1997). *Finland: A Cultural Encyclopedia*. Helsinki: Finnish Literature Society.
- Allison, G. (2008). Emergence of Schools of Public Policy: Reflections by a Founding Dean. In M. Moran, M. Rein, & R. Goodin (Eds), *The Oxford Handbook of Public Policy* (pp. 58-79). Oxford: Oxford University Press.
- Andrews, R., Boyne, G. A., Law, J. & Walker, R. M. (2007). Centralization, Organizational Strategy, and Public Service Performance. *The Journal of Public Administration Research and Theory, Inc.* Retrieved from: Oxford University Press. DOI: 10.1111/j.1467-9299.2007.00695.x
- Asp, E. (2009). Corporate Culture and Corporate Social Responsibility. Unpublished manuscript.
- Argyle, N. J. (1994). Public Administration, Administrative Thought, and the Emergence of Nation State. In A. Farazmand (Ed.), *Hand book of Bureaucracy* (pp. 1-16). New York: Marcel Dekker, Inc.
- Bardach, E. (2006). Policy Dynamics. In M. Moran, M. Rein, & R. Goodin (Eds.), *The Oxford Handbook of Public Policy* (pp. 337-366). Oxford: Oxford University Press.
- Bardach, E. (1980). *The Implementation Game: What Happens After a Bill Becomes a Law* (2nd ed.). Massachusetts: The MIT Press.
- Bass, B. M. & Riggio, R. E. (2006). *Transformational Leadership* (2nd ed.). Mahwah, New Jersey: Lawrence Erlbaum Associates, Publishers.
- Behn, R. D. (1991). *Leadership Counts: Lessons for Public Managers from the Massachusetts Welfare, Training, and Employment Program*. Cambridge, Massachusetts: Harvard University Press.
- Blair, T. (2010). *A Journey*. Great Britain: Hutchinson.

Blanning, T. C. W. (2002). *The Culture of Power and the Power of Culture: Old Regime Europe 1660 – 1789*. New York: Oxford University Press.

Bonner, J. (1986). *Introduction to the Theory of Social Choice*. Baltimore, Maryland: John Hopkins University Press.

Bower, J. L. & Weinberg, M. W. (1988). Statecraft, Strategy, and Corporate Leadership. *California Management Review*, 30 (2), 39-56.

Boxall, P. & Purcell, J. (2008). *Strategy and Human Resource Management* (2nd ed.). Hamsphire: Palgrave Macmillan.

Bozeman, B. (2009). Public Values Theory: Three Big Questions. *International Journal of Public Policy*, 4(5), pp. 369 - 375

Bozeman, B. (2007). *Public Values and Public Interest: Counterbalancing Economic Individualism*. Washington D.C.: Georgetown University Press.

Branson, R. (2008). *Business Strip Bare: Adventures of a Global Entrepreneur*. Great Britain: Virgin Books.

Bratton, J. (2003). *The Context of Human Resource Management. Human Resource Management: Theory and Practice* (3rd Ed.). Bath: Bath Press.

British Civil Service. (2010). The origins of the modern Civil Service: The 1850s. Retrieved from <http://www.civilservice.gov.uk/about/history/1950-60/index.aspx>

Brown, K. (2008). Human Resource Management in Public Sector. In R. S. Beattie and S. P. Osborne (Eds.) *Human Resource Management in Public Sector* (pp. 1-7). London: Routledge Taylor and Francis Group.

Brunssen, N. and Olsen, J.P. (1993). *The Reforming Organization*. London: Routledge.

Bryant, A. and Charmaz, K. (2007). Grounded Theory Research: Methods and Practice. In A. Bryant and K. Charmaz (Eds.), *The Sage Handbook of Grounded Theory* (pp. 1-28). London: Sage.

Bryson, J. M. (2004). *Strategic Planning for Public and Non-Profit Organizations: A guide to Strengthening and Sustaining Organizational Achievements* (3rd ed.). San Francisco: Jossey-Bass.

Burrell, G. & Morgan, G. (1982). *Sociological Paradigms and Organisational Analysis: Elements of Sociology of Corporate Life* (2nd ed.). London: Heinemann.

Cabinet Office. (2010). Civil Service Capability. Retrieved from <http://www.cabinetoffice.gov.uk/civil-service-capability.aspx>.

Caiden, G. E. (1994). Excessive Bureaucratization: The J-Curve Theory of Bureaucracy and Max Weber Through the Looking Glass. In A. Farazmand (Ed.), *Handbook of Bureaucracy* (29-40). New York: Marcel Dekker, Inc.

Calhoun, C. & Sennett, R. (2007). Introduction. In C. Calhoun and R. Sennett (Eds.), *Practicing Culture* (pp. 1-12). London: Routledge.

Christensen, T. (2006). Policy Networks Analysis. In M. Moran, M. Rein, & R. Goodin (Eds.), *The Oxford Handbook of Public Policy* (pp. 448-468). Oxford: Oxford University Press.

Cockman, P., Evans, B. & Reynolds, P. (1999). *Consulting For Real People: A Client-Centred Approach For Change Agents And Leaders* (2nd ed.). London: McGraw-Hill Publishing Company.

Cole, M. and Parston, G. (2006). *Unlocking Public Value: A new Model for Achieving High Performance in Public Organisations*. New Jersey: John Wiley and Sons, Inc.

Colvin, G. (2008). *Talent Is Overrated: What Really Separates World-Class Performers from Everybody Else*. New York: Penguin Group.

Creswell, J. W. (2009). *Research Design: Qualitative, Quantitative, and Mixed Methods Approaches* (3rd Ed.). Thousand Oaks, CA: Sage.

Crowther, D. & Lancaster, G. (2009). *Research Methods: A concise introduction to research in management and business consultancy* (2nd ed.). Hungary: Elsevier.

Desan, S. Crowds, Community and Ritual in the Work of E. P. Thompson and Natalie Davis. In L. Hunt (Ed.) *The New Cultural History* (25-46). Berkeley: University of California Press.

Dingwall, R. & Strangleman T. (2005). Organization Culture in the Public Service. In E. Ferlie, L. E. Lynn Jnr. & C. Pollitt (Eds.), *The Oxford Handbook of Public Management* (pp. 422-445). Oxford: Oxford University Press.

Dunsire, A. (1990). Implementation Theory and Bureaucracy. In Talib Younis (Ed.), *Implementation in Public Policy* (pp. 15-27). Aldershot: Dartmouth Publishing Co.

Drucker, P. ([1972] 2008). *Management*. Clearmont: HarperCollins.

Eddy, W. B. (Ed.) (1983). Issues and Trends in Public Management. In *Hand Book of Organization Management* (pp. 3-20). New York: Marcel Dekker, Inc.

European Commission. (2001). European Governance: A White Paper. Brussels: European Commission. Retrieved from http://europa.eu.int/comm/governance/index_en.htm

Farjoun, M. (2002). Towards an Organic Perspective on Strategy. *Strategic Management Journal* 23 (7), 561-594.

Ferlie, E. & Gerathy, K. J. (2005). Professionals in Public Services Organisations: Implications for Public Sector “Reforming”. In E. Ferlie, L. E. Lynn Jnr. & C. Pollitt (Eds.), *The Oxford Handbook of Public Management* (pp. 422-445). Oxford: Oxford University Press.

- Flynn, N. (2009). *Public Sector Management* (5th ed.). Los Angeles: Sage.
- Fuchs, D. (2007). *Business Power in Global Governance*. Boulder: Lynne Rienner Publishers.
- Fukuyama, F. (2005). *State Building – Governance and World Order in the Twenty-First Century*. Great Britain: Profile Books Ltd.
- Galbraith, J. K. (2004). *The Economics of Innocent Fraud: Truth for Our Time*. London: Penguin Books.
- Gold, J. (2003). *Appraisal and Performance Management: Human Resource Management: Theory and Practice* (3rd ed.). Bath: Bath Press.
- Golombiewski, R. T. Structuring the Public Organisation. In W. B. Eddy (Ed.), *Hand Book of Organization Management* (pp. 193-226). New York: Marcel Dekker, Inc.
- Goodin, R. E., Rein, M. & Moran, M. (2006). The Public and its Policies. In M. Moran, M. Rein, & R. Goodin (Eds), *The Oxford Handbook of Public Policy* (pp. 3-38). Oxford: Oxford University Press.
- Gummesson, E. (2000). *Qualitative Methods in Management Research* (2nd ed.). Thousand Oaks, CA: Sage.
- Haapala, P. (2009). Modernisation of Finland 1800-2000. In M. Perkkio (Ed.), *Perspectives to Global Social Development* (pp.127-138). Tampere: Tampere University Press.
- Hackman and Johnson (2009). *Leadership: A Communication Perspective* (5 ed.). USA: Waveland Press.
- Hakkarainen, A. (2009). *Behind The Screen: Nokia's Success Story in an Industry of Navel-gazing Executives and Crazy Frogs*. Jyväskylä: Gummerus Kirjapaino.
- Hall, T. E. & O'Toole Jr, L. J. (2000). Structures for Policy Implementation- An Analysis for National Legislation, 1965-1966 and 1993-1994. *Administration & Society*, 31(6), 667-686.
- Halligan, J. (2003). Leadership and the Senior Service from a Comparative Perspectives. In G. B. Peters and J. Pierre (Ed.), *Handbook for Public Administration* (pp. 98-108). London: Sage.
- Hansen, M. T. (2009). *Collaboration: How Leaders Avoid the Traps, Create Unity, and Reap Big Results*. Boston: Harvard Business Press.
- Hasenfeld, Y. & Brock, T. (1991). Implementation of Social Policy Revisited. *Administration & Society*, 22(4), 451-479.
- HAUS. (2010). Finnish Institute of Public Management Ltd Overview. Retrieved from <http://www.haus.fi/en/overview/>.

HAUS. (2010). HAUS Becomes Part of State Services for Personnel Administration. Retrieved from http://www.haus.fi/ajankohtaista/uutiset/haus_becomes_part_of_state_services_for_personnel_administration/.

HE 245/2006 vp (Finland). Hallituksen esitys Eduskunnalle laeiksi valtion johtaavista virkamiehistä sekä valtion virkamieslain 4 §:n 2 momentin 2 ja 5 kohdan kumoamisesta ja valtion virkaehtosopimuslain 5 §:n 4 momentin muuttamisesta.

Heikkinen, S. & Tiihonen, S., (2008). Finland's 200th budget - National budget has played a crucial part in the development of Finnish society. Retrieved from www.vm.fi.

Habermas, J. (2008). *Europe: The Faltering Project*. (Trans.) Cronin, C., Cambridge: Polity Press.

Habermas, J. (1984). *The Theory of Communicative Action Vol. I: Reasons and Rationalization of Society*. (Trans.) McCarthy, T. Boston: Beacon Press.

Helsinki Sanomat International Edition. (2011; March 19). Matti Vanhanen guilty of negligent dereliction of duty as Prime Minister. Retrieved from: <http://www.hs.fi/english/article/Matti+Vanhanen+guilty+of+negligent+dereliction+of+duty+as+Prime+Minister/1135263896118>.

Helsinki Sanomat International Edition. (2011; August 13). Former Croatian President defends armament deal with Finnish Patria. Retrieved from: <http://www.hs.fi/english/article/Former+Croatian+President+defends+armament+deal+with+Finnish+Patria/1135262841160>.

Heper, M. (1994). Bureaucracy in the Ottoman-Turkish Polity. In A. Farazmand (Ed.), *Handbook of Bureaucracy* (pp. 659-674). New York: Marcel Dekker, Inc.

Hill, M. & Hupe, P. (2002). *Implementing Public Policy: Governance in Theory and Practice*. London: Sage.

Holbeche, L. (2006). *Understanding Change: Theory, Implementation and success*. London: Elsevier.

Hopkins, J. W. (1994). Administration of the Spanish Empires in the Americas. In A. Farazmand (Ed.), *Handbook of Bureaucracy* (pp. 17-28). New York: Marcel Dekker, Inc.

Hood, C. (2005). Public Management: The Word, the Movement, the Science. In G. B. Peters and J. Pierre (Ed.), *Handbook for Public Administration* (pp. 98-108). London: Sage.

Hulme, D. (2001). The Internationalization of New Public Management. In W. McCourt and M. Minogue (Eds.) *The Internationalization of Public Management: Reinventing the Third World State* (129-152). Cheltenham: Edward Elger.

Hunt, L. (Ed.) (1989). Introduction: History, Culture and Text. In *The New Cultural History* (1-24). Berkeley: University of California Press.

Ikola-Norrbacka, R. & Jokipii, A. (2010). Ethical Values of Professional Investigators of White-collar Crime[abstract]. *Finnish Association for Administrative Studies*, 29(1), 53-68.

Jones, S. D. (2002). Recent Reforms in Singapore's Administrative Elite: Responding to Challenges of Rapidly Growing Economy and Society. *Asian Journal of Political Science*, 10(2), 70-93.

JPO Oy. (2011). Home page – History. Retrieved from <http://www.jto.fi>

Keeling, D. (1972). *Management in Government*. London: George Allen & Unwin Ltd.

KEPA, (2011). <http://www.kepa.fi/international/english>

Kerkhoff, T. (2009). Public values and public interest: Counterbalancing economic individualism. *Acta Politica* 44, 472-475.

Kickert W. J. M. (ed.). (1997). *Public Management and Administrative Reform in Western Europe*. Cheltenham: Edward Elgar.

Kickert, W. J. M. (2007). Public Management Reforms in Countries with a Napoleonic State Model: France, Italy and Spain. In C. Pollitt, van S. Thiel and V. Homburg (Eds.), *New Public Management in Europe: adaptations and alternatives*, (pp. 26-51). UK: Palgrave Macmillan Ltd.

Koivurinta, H. (2006). The Structure of the Finnish Public Administration. In *Finnish Public Management: Building Sustainable Quality* (pp. 3-16). Finland, Edita Prima Ltd.

Kotter, J. P. (1996). *Leading Change*. MA. Boston: Harvard Business School Press.

Koven, S. G. (1994). The Bureaucracy-Democracy Conundrum: A Contemporary Inquiry into the Labyrinth. In A. Farazmand (Ed.), *Handbook of Bureaucracy* (pp. 79-95). New York: Marcel Dekker, Inc.

Kuisma, M. (1999). Europe's Wood Basket Transformed: Finnish Economic History in a Long Perspective. In T. M. S. Lehtonen (Ed.); P. Landon (Trans.) *Europe's Northern Frontier: perspectives on Finland's Western identity* (pp. 50-85). Jyväskylä:PS-kustannus.

Kvale, S. & Brinkmann, S. (2009). *InterViews: Learning the Craft of Qualitative Research Interviewing* (2nd ed.). Los Angeles : Sage.

Linder, S. H. & Peters, G. B. (1989). Instruments of Government: Perception and Context. *International Public Policy*, 9, 35-58.

Loong, L. H. (2009). Keynote Address by Prime Minister at the PSC Scholarships Award Ceremony on Saturday, 25 July. Retrieved from: <http://www.adminservice.gov.sg/AS/TrainDev/>

Loveless, S. & Bozeman, B. (1983). Innovation and the Public Manager. In W. B. Eddy (Ed.), *Handbook of Organizational Management* (391-413). New York: Marcel Dekker, Inc.

Lundquist, L. (1987). *Implementation Steering: An Actor-Structure Approach*. Lund: Studentlitteratur.

Lynn, L. E. Jr. (2005). Public Management: A Concise History of the Field. In E. Ferlie, L. E. Lynn Jr. & C. Pollitt (Eds.), *The Oxford Handbook of Public Management* (pp. 27-50). Oxford: Oxford University Press.

Lynn, L. E. Jr. (2003). Public Management. In G. B. Peters, & J. Pierre, (Eds.), *The Handbook of Public Administration* (pp. 14-24). London: Sage Publications.

Manheim, F. T. (2009). *The Conflict Over Environmental Regulation in the United States: Origins, Outcomes, and Comparisons With the EU and Other Regions*. New York: Springer.

Marshall, C. & Rossman, G. B. (2006). *Designing Qualitative Research* (4th ed.). Thousand Oaks: Sage.

McCarthy, T. (1984). Translator's Introduction. In T. McCarthy, (Trans.) *Theory of Communicative Action Vol I: Reasons and Rationalization of Society* (pp. i-Xliv). Boston: Beacon Press.

Meier, K. J. & Hill, G. C. (2005). Public Management: A Concise History of the Field. In E. Ferlie, L. E. Lynn, C. Pollitt (Eds.) *The Oxford Handbook of Public Management* (pp. 51-71) Oxford: Oxford University Press.

Meyer, J. P. & Allen, N. J. (1997). *Commitment in the Workplace: Theory, Research and Application*. Thousand Oaks: Sage Publication.

Ministry of Finance. (2011). *Selection Criteria for Senior Management Posts in Central Government*. Helsinki: Ministry of Finance. Retrieved from <http://www.vm.fi/vm/en/hakutulos.jsp?query=Selection+Criteria&perushaku=1&hae=Search>

Ministry of Finance. (2011). Organisation Chart. Retrieved from http://www.vm.fi/vm/en/04_publications_and_documents/03_documents/organisaatio_en.pdf

Ministry of Finance. (2009). Milestones in the History of the Ministry of Finance 200th anniversary of the Ministry of Finance. Retrieved from: http://www.vm.fi/vm/en/02_ministry/04_milestones_in_history/index.jsp

Ministry of Finance. (2008). Government Resolution on Central Government Management Policy. Helsinki: Ministry of Finance. Retrieved from http://www.vm.fi/vm/en/04_publications_and_documents/02_documents_on_personnel_management/04_muut_henkilostohallinnon_asiakirjat/20080430Govern/name.jsp

Ministry of Finance. (2007). Guidelines for the Transfer of official within the Government system. Retrieved from: <http://www.vm.fi/vm/en/hakutulos.jsp?query=Guidelines+for+the+Transfer+of+official+with+in+the+Government+system.&perushaku=1&hae=Search>

Ministry of Finance, (2006). *Finnish Public Management: Building Sustainable Quality*. Finland: Edita Prima.

Ministry of Finance. (2005). *Values in Daily Job - Civil Servants' Ethics: A Handbook for the State Administration*. Helsinki: Edita Publishing Ltd.

Ministry of Finance. (6b/2004). *Values to be Part of Daily Jobs*. Helsinki: Edita Prima Ltd.

Ministry of Finance. (2003). *Towards Professional Management in Central Government: A Strategy for Management Development 2002-20012*. Helsinki: Ministry of Finance. (www.vm.fi).

Ministry of Finance. (2002). *Central Government Reforms*. Helsinki: Ministry of Finance.

Ministry of Finance. (2001). *Government Decision in Principle on State Personnel Policy Line*. Helsinki: Kirjapaino Snellman Oy.

Minogue, M. (2001). The Internationalization of New Public Management. In W. McCourt and M. Minogue (Eds.) *The Internationalization of Public Management: Reinventing the Third World State* (1-19). Cheltenham: Edward Elger.

Mintzberg, H. (2009). *Managing*. San Francisco: Berrett-Koehler Publishing.

Mintzberg, H. (1979). *The Structure of Organisations; A Synthesis of the Research*. Englewood Cliffs: Prentice-Hall.

Mohr, L. B. (1982). *Explaining Organizational Behaviour*. San Francisco: Jossey-Bass Publishers.

Mohr, L. B. (1969). Determinants of Innovation in Organisations. *The American Political Science Review*, 63(1), 111-126.

Moore, M. H. (1995). *Creating Public Value: Strategic Management in Government*. Cambridge: Harvard University Press.

Morgan, C. (1990). Pollution Controller, City of Glasgow District Council, Environmental Health Department, 23 Montrose Street, Glasgow. In Talib Younis (Ed.), *Implementation in Public Policy* (pp. 40-52). Aldershot: Dartmouth Publishing Co.

Morgan, G. (2006). *Images of Organizations: Updated edition of the international best seller*. Thousand Oaks: Sage Publications.

Myers, D. M. (2009). *Qualitative Research in Business and Management*. Thousand Oaks: Sage.

Nigro, L. G. (1983). Developing Human Resource for the Public Sector: The New Challenge to Public Management. In W. B. Eddy (Ed.), *Handbook of Organizational Management* (279-296). New York: Marcel Dekker, Inc.

Obama, H. B. (2011). President Obama Speaks to the Parliament in London: "The Time for Our Leadership is Now". Retrieved from: <http://www.whitehouse.gov/blog/2011/05/25/president-obama-speaks-parliament-london-time-our-leadership-now>

Olivecrona, K. (1971). *Law as Fact* (2nd Ed.). London: Stevens & sons.

Organisation for Economic Cooperation and Development. (2010). *Report on the Application of the Convention on Combating Bribery of Foreign Public Officials in International Business Transactions and the 2009 Revised Recommendation on Combating Bribery in International Business Transactions*. Paris: OECD.

Organisation for Economic Co-operation and Development. (2010). *OECD Public Governance Reviews Finland - working together to sustain success*. Paris, OECD.

Organisation for Economic Co-operation and Development. (2001). *Public Sector Leaders for the 21st Century*. Paris: OECD.

Organisation for Economic Co-operation and Development. (2000). *Developing Public Service Leaders for the Future – Background Papers by the Secretariat*. Paris: OECD.

Organization for Economic Cooperation and Development. (2009). *OECD Public Management Review, Finland*. Paris: OECD.

Patton, M. Q., (2002). *Qualitative Research and Evaluation Methods* (3rd ed.). Thousand Oak (CA): Sage Publications.

Peter, L. J. & Hull, R. (2011). *The Peter Principle: Why things always go wrong*. Germany: Bercker.

Peter, L. J. & Hull, R. (1966). *The Peter Principle*. London: Pan Books.

Peters, B. G. (2010). *American Public Policy: Promise and Performance* (8th ed.). Washington: CQ Press, a division of Sage.

Peters, B. G. (2006). Concepts and Theories of Horizontal Policy Management. In B. G. Peters and J. Pierre (Eds.), *Handbook of Public Policy* (pp. 115-138). London: Sage.

Peters, B. G. (2001). *The Future of Governing* (2nd ed.). Lawrence: University Press of Kansas.

Pettigrew, A. M., Ferlie, E. & McKee, L. (1992). *Shaping strategic change: Making change in large organizations: the case of the National Health Service*. London and Newbury Park: Sage Publications.

Pfeffer, J. (1997). *New Directions for Organizational Theory: Problems and Prospects*. USA: Oxford University Press.

Pfeffer, J. (1972). Inerorganizational Influence and Managerial Attitudes. *Academy of Management Journal*, 15, 317 - 330.

Pfeffer, J. & Salancik, G. R. (2003). *The External Control of Organizations: A resource dependence perspective*. California: Stanford University Press.

Polidano, C. (2001). Administrative Reform in Core Civil Services: Application and Applicability of the New Public Management. In W. McCourt & M. Minogue (Eds), *The Internationalization of Public Management: Reinventing the Third World State* (pp. 44-69). Cheltenham: Edward Elger.

Pollitt, C. (2003). *The Essential Public Manager*. United Kingdom: Open University Press.

Pollitt, C. & Bouckaert, G. (2004). *Public Management Reform: A Comparative Analysis* (2nd ed.). Oxford: Oxford University Press.

Pressman, J. L. & Wildavsky, A. B. (1984). *Implementation: how great expectations in Washington are dashed in Oakland* (3rd ed.). Berkely: University of California.

Ragin, C. C. (2007). Comparative Methods. In W. Outhwaite & S. P. Turner (Eds.), *The SAGE Handbook of Social Science Methodology* (pp. 67-81). London: Sage Publications.

Rhodes, R. A. W. (2008). Policy Networks Analysis. In M. Moran, M. Rein, & R. Goodin (Eds.), *The Oxford Handbook of Public Policy* (pp. 425-447). Oxford: Oxford University Press.

Rhodes, R. A. W. (1997). *Understanding Governance: Policy Networks, Governance, Reflexivity and Accountability*. Buckingham: Open University Press.

Riggs, F. W. (1994). A Profound Puzzle for Presidentialism. In A. Farazmand (Ed.), *Handbook of Bureaucracy* (pp. 97-148). New York: Marcel Dekker, Inc.

Rokkan, S. (1999). *State Formation, Nation Building, and Mass Politics in Europe: The Theory of Stein Rokkan*; Eds. P. Flora, S. Kuhnle & D. Urwin. Oxford: Oxford University Press.

Rosenbaum, A. and Kauzya, J-M (2006). Introduction. In A. Rosenbaum, and J-M. Kauzya (Eds.), *Excellence and Leadership in the Public Sector: The role of training* (pp. v-vii). New York: United Nations.

Rouban, L. (1997). The Administrative Modernisation Policy in France. In W. J. M. Kickert (Ed.), *Public Management and Administrative Reform in Western Europe*. (pp. 141-156). Cheltenham: Edward Elgar.

Schedler, K. (1997). The State of Public Management Reforms in Switzerland. In W. J. M. Kickert (Ed.), *Public Management and Administrative Reform in Western Europe*. (pp. 121-140). Cheltenham: Edward Elgar.

Schein, E. H. (2004). *Organizational culture and leadership* (3rd ed.). USA: John Wiley and Sons.

Scholte, J. A. (2000a). *Globalization: A Critical Introduction*. Basingstoke: Palgrave Macmillan.

Schuler, R. S. and Jackson, S.E. (1996). *Human Resource Management: Positioning for the 21st Century* (6th ed.). New York: West Publishing Company.

Selznick, P. (1957). *Leadership in Administration*. New York: Harper & Row.

Senge, P. M. (2006). *The Fifth Discipline: The Art & Practice of the Learning Organisations*. U. K.: Random House Business Books.

Sennett, R. (2008). *The Craftsman*. New Heaven & London: Yale University Press.

Shafritz, M. J. and Russell, E. W. (2003). *Introducing Public Administration* (3rd ed.). New York: Longman.

Shafritz, M. J., Hyde, A. C. & Rosenbloom, D. H. (1986). *Personnel Management in Government: Politics and Process* (3rd ed.). New York: Marcel Dekker, Inc.

Sheng, Y. K./ United Nations Economic and Social Commission for Asia and the Pacific. (2011). What is Good Governance? Bangkok 10200, Thailand: UNESCAP Research & Publications. Retrieved from: <www.unescap.org/pdd>

Simon, H. A. (1997). *Administrative Behaviour: a study of decision-making processes in administrative organizations* (4th ed.). New York: The Free Press.

Stiglitz, J. (2010). *Freefall: America, Free Markets, and the Sinking of the World Economy*. New York: W. W. Norton & Company.

[Suomi.fi/State Treasury](http://www.suomi.fi/State_Treasury). (2011). State Administration and Central Government. Retrieved from http://www.suomi.fi/suomifi/english/in_focus/functioning_of_public_administration/state_administration_and_central_government/index.html

Taylor, H. (2001). Human Resource Management: Two Sides of a Coin that has a Low Value in Developing Countries? In W. McCourt and M. Minogue (Eds.), *The Internationalization of Public Management: Reinventing the Third World State* (174-195). Cheltenham: Edward Elger.

Temmes, M. and Sootla, G. (2004). Introduction. In *Models of Administrative Reform Units: A Comparison of Finland, Estonia and Russia* (pp. 1-19). Helsinki: Department of Political Science.

The Constitution of Finland. (1999/2007). *The Constitution of Finland*. Helsinki: Ministry of Justice.

The Wall Street Journal. (2011; January 4). Corruption Currents. Retrieved from <http://blogs.wsj.com/corruption-currents/2011/01/04/finland-expands-patria-bribery-investigation-into-croatia-sales/>

Tiihonen, S. (2001) Finland Overview. Retrieved from: <http://www1.worldbank.org/publicsector/civilservice/rsFinland.pdf>.

Tiihonen, S. (2004) *From Governing To Governance: a process of change*. Tampere: Tampere University Press.

Thiel, V. S., Steijn, B. & Allix, M. (2007). 'New Public Managers' in Europe: Changes and Trends. In C. Pollitt, V. S. Thiel, & V. Homburg (Eds.), *New Public Management in Europe: adaptations and alternatives* (pp. 90-106). New York: Palgrave MacMillan.

Tiili, M. (2008). Ministers as strategic political leaders? Strategic political steering after NPM reforms in Finland. (Doctoral Thesis, University of Helsinki, Helsinki, Finland). Retrieved from <https://helda.helsinki.fi/handle/10138/21833>.

Torenlid, R. & Thomson, R. (2003), Is Implementation Distinct from Political Bargaining? *Rationality and Society*, 15(1), 64-84.

Turunen, J., Karjalainen, J. & Metsäpelto, T. (2006). [Forward] Modernising Government the Finnish Way in Finnish Public Management: Building Sustainable Quality. Finland: Edita Prima Ltd., pp. i-v.

United Nations Development Programme. (2010). 2010 Global Programme Annual Report: Accelerating Access to Justice for Human Development - A UNDP Rule of Law Initiative. New York: Access to Justice/Rule of Law/ Security Democratic Governance Group Bureau for Development Policy UNDP Research & Publications. Retrieved from http://www.beta.undp.org/undp/en/home/librarypage/democratic-governance/access_to_justiceandruleoflaw/2010_global_programmeannualreportacceleratingaccesstojusticeforh.html

Valtion virkamieslaki 1994/750 (State Civil Servants Act 750/94) Retrieved from: <http://www.finlex.fi/fi/laki/ajantasa/1994/19940750>

Van Wart, M. (2005). *Dynamics of Leadership in Public Service: Theory and Practice*. Armonk, New York: M.E. Sharpe.

Vartola, J. (1999). Some Critical Remarks on Modern Bureaucracy Especially in European Welfare States. *Social Science Review: A multi-disciplinary journal of social science*, Vol. xvi(1), 1-18.

Vedung, E. (2002). *Public Policy and Program Evaluation*. New Brunswick (USA): Transaction Publishers.

Wallin, B. K. (2003). Skills Provision in Swedish Public Administration – Some Distinctive Features: The Swedish Government's Political Objectives Strategy and Measures; Central Government Agencies' Practical Approach; Current Problems and ongoing Development Efforts. Address at the OECD/PUMA symposium *Learning Government* in Paris, 4 February.

Weiss, C. H. (1998). *Evaluation: Methods for studying Programs and Policies*. Upper Saddle River, New Jersey: Prentice Hall.

Winter S. (2006). Implementation. In G. B. Peters, & J. Pierre (Eds.), *Handbook of Public Policy* (pp. 151-166). London: Sage.

Wojciechowski, J. A. (Ed.). (1971). *Conceptual Basis of the Classification of Knowledge*. New York, K. G. Saur.

Yip, J. and Wilson, M. (2008). Developing Public Service Leaders in Singapore, Center for Creative Leadership. Retrieved from: www.ccf.org.

Younis, T. and Davidson, I. (1990). The Study of Implementation. In T. Younis (Ed.) *Implementation in Public Policy* (pp. 3-15). Aldershot: Dartmouth Publishing Co.

Yukl, G. (2010). *Leadership in Organizations* (7th ed.). Upper Saddle River, New Jersey :Prentice Hall.

Appendices

Appendix 1

Dear ...,

I would be grateful if you could have a not more than an hour interview with me.

I am a Ghanaian postgraduate student at Tampere yliopisto and studying public sector reforms and leadership. I would therefore wish to talk with you and to find out how you have been leading with or without the 2003 Ministry of Finance's Management Development Plan for top level civil servants in Suomi.

The study is hoped to add value both theoretically and practically to public management development.

My Professor is Risto Harisalo.

I look forward to hearing from you soon and counting on your cooperation.

Warm regards,

Mohammed Ibn Mukhtar

(044 032 6609)

Appendix 2

Hämeenkatu 11A 805
33100 Tampere
Mohammed.mukhtar@uta.fi
044 032 6609
09.01.11

The President of Finland
Mariankatu 2
00170 Helsinki

Dear President Tarja Halonen,
An Appointment for an Interview for a doctoral Thesis

I would wish to have the opportunity to be granted an interview for my doctoral studies. I am a Ghanaian. I study public management reforms at Tampere yliopisto. Specifically, I am looking at a Finnish Government Management Development for Senior Civil Servants reform that started in 2002 to 2012. The document is called Towards Professional Management in Central Government (Ammattimaiseen Johtamiseen Valtionhallinnossa). According to Government Resolution Paper released in 2008 the program will be evaluated this year, 2011. I am, therefore, racing time to get my report out ahead of this evaluation exercise so that it could be useful to the system already.

In one of the implementation processes you submitted to Parliament a bill that could not be passed. This bill was on the mobility and creation of “job bank” of top level government leaders for government services. I have so far interviewed 31 government managers including the Parliamentary Committee on Public Administration. Considering your role as mandated by the Constitution to appoint top level managers for the government and other state institutions, your input is vital and irreplaceable in this process.

I will, therefore, wish to know your personal contribution and involvement in this government manager development. I will, also, wish to know what your candid views about, and input for the development of best Finnish public manager. Your contributions would add up to the generation of both theory and practice for development of Finland, Ghana and the rest of the world.

Professor Risto Harisalo is my supervisor.

Thank you.
Yours Sincerely,

Mohammed Ibn Mukhtar

Appendix 3

Date: Wed, 16 Mar 2011 10:47:49 +0200 [16/03/11 10:47:49 EEST]

From: Heli.Sariola@tpk.fi <Heli.Sariola@tpk.fi>  

To: Mohammed.mukhtar@uta.fi 

Subject: Your interview request with the President

Alternative parts for this section: 



[unnamed](#) 1 KB



[Show this HTML in a new window?](#)

A/18581/2011

Dear Mohammed Ibn Mukhtar,

Thank you for your e-mail with a request for an interview to the President of the Republic of Finland for your doctoral thesis.

The theme of the thesis is interesting indeed. However, the President is unfortunately unable to agree to your request due to the tight schedule of her official duties for the forthcoming months.

On behalf of President of the Republic I thank you for your consideration and wish success with your doctoral studies.

Best regards,

Heli Sariola

Press Attaché

Office of the President of the Republic of Finland

Appendix 4

The Questions and Interview Categories

General questions to all groups:

1. Please, are you aware of the Finnish Government's Vision for the top Senior Civil Servants Development? If yes, please how did you know about it?
2. Do you use it (the policy) or not for your everyday management and leadership processes?
3. Would you have comments about the visionary values stated there?
4. What would you say to support future developments of Finnish Government Managerial and Leadership?
 - **Program Owners**
 - 5. How have you been going around putting your Senior Civil Servants Vision in place?
 - 6. Are the politicians supportive (also to beneficiaries)?
 - 7. What would you tell to be the program achievements so far?
 - **Beneficiary Participants**
 - 8. Please, explain the processes by which you use the policy; and, ii) if no, please tell how you develop yourself and your subordinates towards this top position?
 - 9. Are you in direct touch with the Program Owners/Ministry of Finance on this policy?
 - **Relevant Implementers**
 - 10. Has the Ministry of Finance/Program Owners ever invited you for something related to this Vision 2012 policy?

Thank you!!!

Appendix 5

Interviewee-List

Staff/Government Manager Beneficiary Participants

Tapio Mutikainen	Markus Sovala
Ari Holopainen	Soili Vasikainen
Katju Holkeri	Virpi Einola-Pekkinen
Teuvo Metsäpelto	Pekka Nurmi
Päivi Laajala	Håkan Mattlin
Jukka Pekkarinen	Peter Nyberg
Kari Välimäki	Juhani Turunen
Jarmo Littunen	Anne Puonti
Matti Hetemäki	Auni-Marja Vilavaara
Jussi Luomajärvi	Tiina Astola
Kohvakka Aulis	Ritva Viljanen
Hirvelä Jukka	Ari Rouhe
Leo Suomaa	

Relevant Participants/Observers

Veijo Nivala	Sirkka Hautojärvi
Ossi Lantto	Tapani Mäkinen
Tuula Sivonen	Seppo Mansukoski
Pauli Juuti	Peter Kanerva
Markku Temmes	Markku Kiviniemi
Seppo Määttä	

Appendix 6

The ministerial Structure:

- The Prime Minister's Office – Headed by The Prime Minister; deputised by a State Secretary whose appointment is linked to the Prime Minister's term of office, directs and supervises the functioning of the Prime Minister's Office; assisted by the Permanent State Under-Secretary being the highest civil servant; also, not reporting directly to an elected official as found in the president's office.
- The Ministry for Foreign Affairs – Headed by the Minister for Foreign Affairs is led by the Minister for Foreign Affairs who is in charge of the government department; Minister for Foreign Trade and Development and Minister of Housing, who also dubs as Minister for Nordic Cooperation. The Ministry's highest civil servants are the Permanent Secretary who is supported by four Permanent Under-Secretaries of State.
- The Ministry of Justice – Headed by the Minister of Justice and supported by a Permanent Secretary.
- The Ministry of Interior - Headed by the Minister of the Interior, the Minister of Migration and European Affairs, with a Permanent Secretary.
- The Ministry of Defence – Headed by the Minister of Defence, and supported by a permanent secretary.
- The Ministry of Finance – Headed by the Minister of Finance; and, the Minister of Public Administration & Local Government. The highest civil servant at the Ministry is the Permanent Secretary of State, assisted by two Permanent Under-Secretaries of State.
- The Ministry of Education and Culture – Headed by the Minister of Education, Science & Research; and the Minister of Culture & Sports. A permanent secretary assists.
- The Ministry of Agriculture and Forestry – Headed by a Minister and supported by a permanent secretary.
- The Ministry of Transport and Communications – Headed by the Minister of Transport, and the Minister of Communications. The highest-ranking permanent official at the Ministry is the Permanent Secretary.
- The Ministry of Employment and Economy – Led by Minister of Economic, and Minister of Labour; a Permanent Secretary and 3 Permanent Under-Secretaries.
- The Ministry of Social Affairs and Health – Headed by three ministers, that is, Social Affairs and Health, Health and Social Services, Gender Equality Affairs, and a permanent secretary.
- The Ministry of the Environment – Headed by the Minister of the Environment, and the Minister of Housing; with a permanent secretary.

