



TAMPEREEN TEKNILLINEN YLIOPISTO  
TAMPERE UNIVERSITY OF TECHNOLOGY

BILAL WARIS  
DEVELOPMENT AND TESTING OF SPLIT-RING ANTENNAS FOR  
WEARABLE ELECTRO-TEXTILE UHF RFID TAGS

Master of Science thesis

Examiner: Postdoctoral Researcher  
Toni Björninen and prof. Leena  
Ukkonen.

Examiner and topic approved by the  
Faculty Council of the Faculty of  
Computing and Electrical  
Engineering on 23 February 2016

## ABSTRACT

**Bilal Waris:** Development and Testing of Split-ring Antennas for Wearable Electro-textile UHF RFID Tags.

Tampere University of Technology

Master of Science Thesis, 48 pages, 00 Appendix pages

Oct 2016.

Master's Degree Programme in Electrical Engineering.

Major: Wireless Communications

Examiner: Postdoctoral Researcher Toni Björninen and Professor Leena Ukkonen.

Keywords: RFID, Wearable antennas, Split ring antenna, Body area networks, Electro-textile.

Wireless body area network(WBAN) is developed from personal area network that helps different sensors to communicate while being worn on human body. The passive UHF (Ultra-high frequency) RFID (Radio frequency identification technology) is one of the fundamental technology used for tracking animals, people and objects. Currently, an emerging area of development is the use of wearable RFID tags in health care systems. The personal healthcare systems demand information about sensed or measured biological parameters to be reliable and rapidly sent over a wireless communication link for investigation purposes. Furthermore, the communication system must be absolutely flexible, low-power, maintenance-free and low-cost in order to be utilized on different parts of the patient's body for continuous monitoring of physiological parameters such as blood pressure, body temperature, glucose level, and respiration system.

Therefore, due to the extensive need for the implementation on flexible and conformal material, researchers have been working on textile based RFID tags. One of the hottest topics is the development of electro-textile based RFID tags for body area networks. In this thesis, to measure the performance of wearable split ring antennas on electro-textile material, different split ring antennas have been developed that are materialized with two different kinds of materials such as copper and electro-textile.

The development of wearable antenna is quite challenging task due to antenna material properties, environmental issues and radiation absorbing nature of human body at higher frequencies. By considering these factors, 85% antenna-IC power transfer efficiency at 915MHz has been achieved in body-worn configuration. Furthermore, to analyze the near body performance of developed antenna, distance between antenna and the human body has been varied, for example 2 mm, 3mm, 5mm and air. Moreover, to measure the performance of antenna on clothes, EPDM (Ethylene-Propylene-Diene-Monomer) substrate of different thicknesses i.e 2mm and 5mm have been used.

From the simulated and measured results, it has been noticed that copper based split ring UHF RFID tag shows excellent match between measured and simulated results in body-

worn configuration. Furthermore, provides excellent tag performance at variable antenna-body separations down to two millimeters and also in the air. Interestingly, this is novel feature of wearable antennas based on a single conductor layer.

On the other hand, it has been analyzed that electro-textile based split ring RFID tag shows some variation between simulated and measured on-body/off-body results.

## PREFACE

The master thesis, “Development and Testing of Split-Ring Antennas for Wearable Electro-Textile UHF RFID Tags” was carried out in partial fulfilment of requirement for the Master of Science degree in Electrical Engineering at the department of Electronics and Communication Engineering, Tampere University of Technology, Finland. All the research covered under this work is done at Wireless Identification and Sensing Systems (WISE) research group at Tampere University of Technology, under the kind supervision of Postdoctoral Researcher, Dr. Toni Björninen.

I would like to express heartiest thanks for my supervisor Toni Björninen, who helped me a lot during my thesis work. I would like to thank to Johanna Virkki, it was an enormous pleasure to work under her supportive supervision.

I would like to thank to prof. Leena Ukkonen. I studied almost 50 credits of RFID (including master’s thesis) under her kind supervision and I really learned a lot.

I would really like to thank to my parents for their tremendous support. Especially, I would like to thank to my late father who always bolstered me through each conceivable way.

Tampere, 12.10.2016

Bilal Waris

# CONTENT

1.	<b>INTRODUCTION</b> .....	1
2.	<b>ELECTROMAGNETISM AND ANTENNA THEORY</b> .....	3
2.1	Electric field .....	3
2.2	Magnetic field .....	3
2.3	Plane wave properties.....	3
2.4	Radiation mechanism.....	5
2.5	Antenna parameters .....	7
2.6	Types of antennas.....	13
2.6.1	Wire antennas.....	12
2.6.2	Aperture antennas.....	14
2.6.3	Antenna array.....	16
2.6.4	Microstrip antennas.....	16
2.7	Propagation.....	17
2.8	Multipath propagation.....	18
2.9	Path loss and link budget.....	20
3.	<b>RADIO FREQUENCY IDENTIFICATION TECHNOLOGY (RFID)</b> .....	21
3.1	Introduction .....	21
3.2	Frequency bands for RFID.....	22
3.3	Passive, semi-passive and active tags.....	23
3.4	UHF RFID microchip.....	25
3.5	The art of UHF RFID antenna design.....	26
3.5.1	Methods for conjugate impedance matching.....	26
3.5.2	Methods for size reduction.....	26
3.5.3	Other designing techniques.....	26
4.	<b>WEARABLE ANTENNAS</b> .....	28
4.1	Body area networks(BAN).....	28
4.2	Body-centric communication systems.....	28
4.3	History of wearable antennas.....	29
4.3.1	Fundamental challenges of wearable antenna development.....	29
4.3.2	Solving the issues of wearable antenna design.....	30
4.4	Development of wearable electro-textile split ring RFID tag.....	30
4.4.1	Simulation steps.....	36
4.4.2	Simulation results and wireless testing of copper based RFID tag .....	37
4.4.3	Electro-textile RFID tag.....	40
5	<b>PUBLICATIONS</b> .....	43
6.	<b>CONCLUSION</b> .....	44

**REFERENCES**.....45

## LIST OF FIGURES

<i>Figure 2.1 . A Propagating plan wave.....</i>	<i>3</i>
<i>Figure 2.2. Polarization states.....</i>	<i>4</i>
<i>Figure 2.3 . Cylinder wire of circular cross section.....</i>	<i>6</i>
<i>Figure 2.4. Electric field lines through antenna.....</i>	<i>7</i>
<i>Figure 2.5 . Radiation from an ideal dipole.....</i>	<i>8</i>
<i>Figure 2.6. Circuit of transmitting antenna.....</i>	<i>9</i>
<i>Figure 2.7. Basic dipole antenna.....</i>	<i>13</i>
<i>Figure 2.8 . Different length of dipole.....</i>	<i>14</i>
<i>Figure 2.9. Circular loop antenna.....</i>	<i>15</i>
<i>Figure 2.10 . Aperture antenna.....</i>	<i>15</i>
<i>Figure 2.11. Rectangular patch antenna.....</i>	<i>16</i>
<i>Figure 2.12 . Reflection.....</i>	<i>17</i>
<i>Figure 2.13. Diffraction.....</i>	<i>18</i>
<i>Figure 2.14 . Scattering.....</i>	<i>18</i>
<i>Figure 2.15. Multipath Propagation.....</i>	<i>19</i>
<i>Figure 2.16 . Fading.....</i>	<i>20</i>
<i>Figure 3.1. RFID system.....</i>	<i>22</i>
<i>Figure 3.2 . RFID frequency bands.....</i>	<i>22</i>
<i>Figure 3.3. Passive backscatter RFID system.....</i>	<i>24</i>
<i>Figure 3.4. UHF tag reader.....</i>	<i>25</i>
<i>Figure 4.1. Developed split ring antenna.....</i>	<i>30</i>
<i>Figure 4.2. Copper based Split ring antenna (a)EPDM substrate(b)Split ring RFID tag. .....</i>	<i>32</i>
<i>Figure 4.3 . Radiation pattern of split ring antenna.....</i>	<i>33</i>
<i>Figure 4.4. IC Power transfer efficiency.....</i>	<i>33</i>
<i>Figure 4.5. Directivity.....</i>	<i>34</i>
<i>Figure 4.6. Radiation efficiency.....</i>	<i>34</i>
<i>Figure 4.7 . On body impedance.....</i>	<i>35</i>
<i>Figure 4.8. Off-body impedance.....</i>	<i>35</i>
<i>Figure 4.9 . Radiation boundary.....</i>	<i>36</i>
<i>Figure 4.10 . Voyantic tagformance measurement system .</i>	<i>38</i>
<i>Figure 4.11 . Simulated and measured attainable read range of copper based RFID tag.....</i>	<i>39</i>
<i>Figure 4.12 . On-body simulated attainable read range. ....</i>	<i>39</i>
<i>Figure 4.13 . Electro-textile split ring RFID tag.....</i>	<i>40</i>
<i>Figure 4.14. Simulated and measured results of e-textile and copper based tags in air.....</i>	<i>41</i>
<i>Figure 4.15 . On-body simulated results of RFID tag based on electro-textile and copper material. ....</i>	<i>41</i>

## LIST OF SYMBOLS AND ABBREVIATIONS

LHCP	Left Hand Circular Polarization
RHCP	Right Hand Circular Polarization
CP	Circular Polarization
WBAN	Wireless Body Area Network
RFID	Radio Frequency Identification Technology
UHF	Ultra-high Frequency
BAN	Body Area Network
dB	Decibel
IEEE	Institute of Electrical and Electronics Engineers
HFSS	High Frequency Structure Simulator
PIFA	Planar Inverted F Antenna
EPDM	Ethylene Propylene Diene Monomer
WPAN	Wireless Personal Area Network
WLAN	Wireless Local Area Network
SRR	Split Ring Resonator
IC	Integrated Circuit
EIRP	Isotropic Radiated Power
EM	Electromagnetic
mm	Millimeter
C	Coulomb
Q	Electric Charge
Wb	Weber
N	Newton
B	Magnetic Flux Density
$\mu_0$	Magnetic Permeability
J	Current Density
M	Magnetization Vector
E	Electric Field
H	Magnetic Field
R	Real
X	Imaginary
Z	Impedance
$\Gamma$	Reflection Coefficient
$\mu$	Permeability of the Medium
D	Directivity
$\delta$	Tangent Loss
$\Omega$	Ohm
GHz	Giga Hertz
%	Percentage
MHz	Mega Hertz



# 1. INTRODUCTION

Recently, wireless body area network (WBAN) that incorporates different sensor devices for wireless communication has become an incredible source of investigation in military, health and environmental application [1]. The most demanding area of implementation is the continuous monitoring of patient's health. Therefore, WBAN systems can be characterized in two wearable body area networks. One that could be implantable inside human body and other that could be worn on human body to monitor physiological parameters such as blood pressure, glucose level and heart activities [2-3]. The fundamental approach in designing and development of these wearable sensors for WBAN is the use of passive UHF (ultra-high frequency) RFID tags [4-5].

In this thesis, split ring antenna has been developed that is based on single-layer in body-worn configuration. There are fundamental challenges during construction of wearable antennas, one of them arises due to the direct placement of antennas on human body. The reason is that, antennas that are close to the human body generally show a dramatic change in radiation efficiency in comparison to the antennas in space because human body absorbs some of the radiated energy of antenna based on different dielectric properties of biological tissues at different UHF frequencies. In a result, the antenna efficiency and radiation pattern are greatly affected. Furthermore, the movement of person or change in position results in change in geometry of wearable antennas, that also affects the antenna performance [6][8].

Secondly, rigid and hard materials are normally used for the manufacturing of antennas which are not advisable for wearable antennas. Wearable antennas have their own requirements because these antennas are used while being worn. Therefore, wearable antennas should be light weight and should have good conductor properties. In this regard, textile material for the development of wearable antennas can be used but textile material can badly affect the performance of antennas due to the moisture in the air which in turn badly affect the resonance frequency of antenna. Furthermore, the dielectric and electrical properties of textile material are not good enough to meet the requirement. Hence, to overcome the problem, a better textile material has been used in this project, for example, textile material (conductive nickel and copper-plated Less EMF Shieldit Super Fabric, Cat. #A1220, sheet resistance of  $0.16 \Omega/\text{sq}$ ) gives better results in comparison to copper conductive sheet [7-8].

This document is structured as follows. Chapter 1 starts with the introduction of thesis, chapter 2 discusses briefly, the background history and some basics of electromagnetism, antenna theory,

and wave propagation, chapter 3 starts with some basics of RFID systems and covers, the UHF passive tags. Finally, the last and the most important chapter 4, initially introduces background theory of wireless body area networks and wearable antennas that later develops into split ring antenna development, fabrication and measurements.

## 2. ELECTROMAGNETISM AND ANTENNA THEORY

### 2.1 Electric field

Electric field ( $V/m$ ) is defined as force ( $N$ ) per unit charge ( $C$ ). The strength of electric field is dependent on the amount of charge and distance from it. It is given as,

$$E = \frac{F}{Q} = \frac{Q}{4\pi\epsilon r^2} \vec{r} \quad (2.1)$$

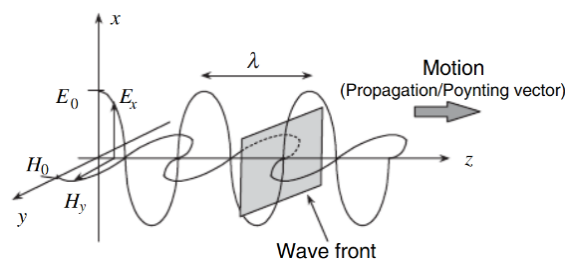
where,  $Q$  is the electric charge,  $\epsilon$  is the electric permittivity of the medium and  $r$  is the distance from the electric charge [16].

### 2.2 Magnetic field

Magnetic field is generated by electric current (measured in amperes) that is, by the movement of electrons. Magnetic flux density  $B$  ( $\frac{Wb}{m^2}$ ) is defined using curl and divergence in magneto statics due to time invariant currents [16].

### 2.3 Plane wave properties

Solution of Maxwell's equations represent sum of plane waves which demonstrates the simplest possible time varying solution.



**Figure 2.1** A propagating plan wave [13].

The electric and magnetic fields shown in Figure 2.1 are perpendicular to each other and to the direction of propagation of the wave. Wave propagates along the  $z$  axis, the vector in this direction is known as pointing vector. Both fields are in phase at any point in time or in space. Their

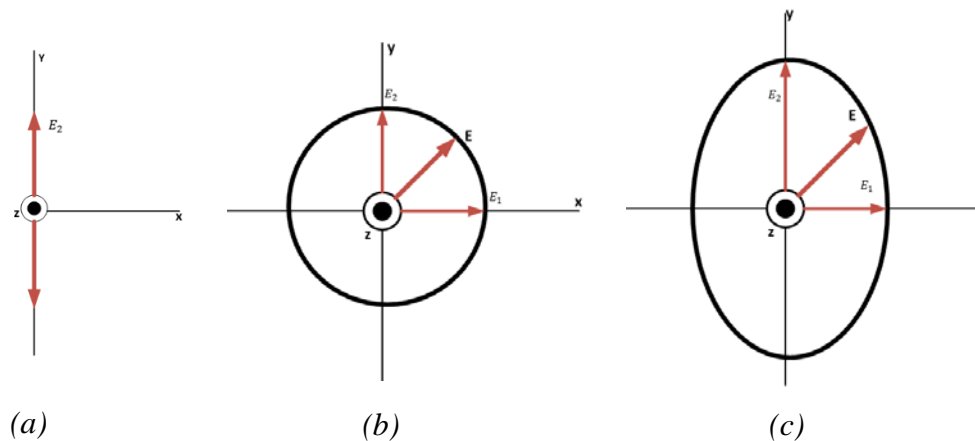
magnitude is constant in xy plane, and a surface of constant phase (wave front) forms a plane parallel to the xy plane. The oscillating electric field produces a magnetic field which itself oscillates to recreate an electric field and so on. This interplay between the two fields stores energy hence, carries power along the pointing vector. Variation or modulation of the properties of the wave (amplitude, frequency or phase) then allows information to be carried in the wave between its source and destination which is the central aim of wireless communication system [13].

- **Polarization**

“The alignment of the electric field vector of a propagating electromagnetic wave relative to the direction of propagation defines the polarization of the wave” [13]. A propagating electromagnetic wave consists of electric field and magnetic field vectors. Therefore, the electric field for the wave can be written as [11].

$$E = E_1 \cos \omega t \hat{x} + E_2 \cos(\omega t + \delta) \hat{y} \quad (2.2)$$

where,  $E_1$  and  $E_2$  are the peak values of electric field  $E$  along x and y-axis and  $\delta$  is the phase by which the y-component leads the x-component.



**Figure 2.2** Polarization states

When  $E_1$  or  $E_2$  is zero in equation 2.2, then the wave is linearly polarized that is vertical or horizontal polarization respectively, as shown in the Figure 2.2(a).

When  $E_1 = E_2$  and  $\delta = \pm 90^\circ$  then the polarization is circular ( $+90^\circ$  is left-hand circular which means electric field vector rotates clockwise and the direction of wave is out of page and  $-90^\circ$  is right-hand circular which means electric field vector rotates anti-clockwise), as shown in the Figure 2.2 (b).

When  $E_1 \neq E_2$ , and  $\delta \neq 0$  it means electric field and magnetic field both have different magnitude and  $E$  field vector varies in both  $x$  and  $y$  planes. Therefore, such kind of polarization is known as elliptical polarization as shown in 2.2(c)

The polarization of an antenna is same as radiated wave polarization. Normally, the polarization of wave radiated by an antenna changes with direction. However, it remains the same over its main beam. Therefore, the polarization at main beam is used to describe antenna polarization. Hence, it is very important that polarization of transmitting antenna should match the polarization of receiving antenna for example, right hand circularly polarized receiving antenna is only matched to right hand circularly polarized wave [11].

## 2.4 Radiation mechanism

The guided and free space electromagnetic waves through antenna behave exactly the same as we create a disturbance by throwing a stone in water. Due to the disturbance in water, water waves are created that move away from the disturbing point. Hence, if disturbance is removed, the waves still remain there and keep continue their journey in upward direction. However, if disturbance is persisted, then new water waves are generated and follow the waves that were generated earlier.

Now let us consider, a conducting wire. Due to the physical properties of conductor, current flows through it as a result of motion of charges. Figure 2.3 shows a conductor having an electric charge density  $q_v$  ( $C/m^3$ ) that is distributed uniformly over the cross-sectional area  $A$  and volume  $V$ . The total charge  $Q$  within volume  $V$ , moving in the  $z$  direction with a uniform velocity  $v_z$  ( $\frac{m}{s}$ ) over the cross section of wire is given by,

$$J_z = q_v v_z \quad (2.3)$$

If the wire is very thin, then current through the wire can be given as,

$$I_z = q_l v_z \quad (2.4)$$

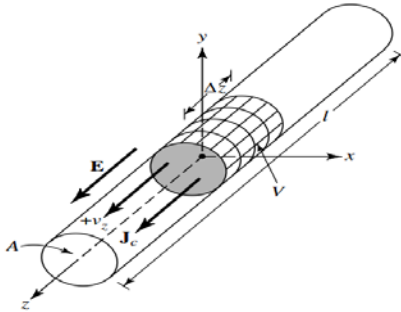
where,  $q_l$  ( $\frac{C}{m}$ ) is the charge per unit length.

If the current through wire is time varying, then the derivative of current can be given as,

$$\frac{dI_z}{dt} = q_l \frac{dv_z}{dt} = q_l a_z \quad (2.5)$$

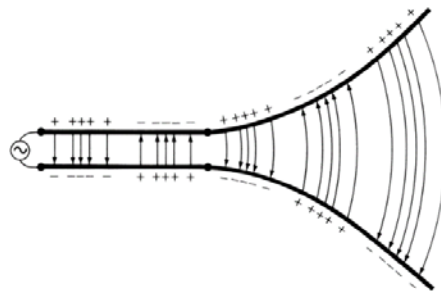
where,  $\frac{dv_z}{dt} = a_z \left(\frac{m}{s^2}\right)$  is the acceleration.

Equation 2.5 represents the basic relation of electromagnetic radiation that simply means, the radiations are produced due to time varying current or an acceleration or deceleration of charges and the charge acceleration is only produce, when the wire is curved, bent or discontinuous.



**Figure 2.3** Cylinder wire of circular cross section [10].

However, in case of transmission lines. Figure 2.4 shows transmission line of two conductors that are connected to an antenna. The conductors are connected with a voltage source that creates electric field between the conductors. Due to this electric field, electric lines of force depending on the strength of electric field are created which are tangent to electric field. These electric lines of force act on free electrons and force them to move. Therefore, due to the motion of charges, current is generated that results in magnetic field intensity and that ultimately creates magnetic lines of force that are also tangent to magnetic field. Now if a sinusoidal voltage source is applied, then it means the electric field between the conductor is also sinusoidal which results in the time varying electric and magnetic fields that move along the transmission line. These electromagnetic fields enter to antenna and cause the flow of current. Finally, these guided electromagnetic waves move away from antenna to form free space waves. Hence, the new waves are generated continuously as long as sinusoidal voltage source is connected.



**Figure 2.4** Electric field lines through antenna [10].

## 2.5 Antenna parameters

- **Radiation pattern**

An antenna radiation pattern or antenna pattern is defined as “a mathematical function or a graphical representation of the radiation properties of the antenna as a function of space coordinates”. The radiation pattern is usually plotted on a logarithmic scale or more commonly in decibels (dB) [10]. Radiation pattern of antenna can be represented by equation,

$$U = r^2 S \quad (2.6)$$

where,  $U$  is radiation intensity measured in watts per unit solid angle,  $S$  is power density measured in watts per square meter and  $r$  is the distance from antenna [13].

The simplest radiation pattern at far field for an isotropic antenna can be obtained that is, if the total power radiated by the antenna is  $P$ , then the power spreads over a uniform sphere of radius  $r$ . Therefore, the power density at this distance in any direction can be given as,

$$S = \frac{P}{\text{area}} = \frac{P}{4\pi r^2} \quad (2.7)$$

So, the radiation intensity can now be written as,

$$U = r^2 S = \frac{P}{4\pi} \quad (2.8)$$

where  $P$  is the poynting vector (directional flux density) that removes the effect of distance and ensures that the radiation pattern is same at all distances from the antenna [13].

In case of ideal dipole antenna, the time-averaged poynting vector is given as,

$$S_{av} = \frac{1}{2} E_{\theta} H_{\phi}^* \hat{r} \quad (2.9)$$

where  $*$  denotes the complex conjugate,  $\theta$  is vertical variation of electric field and  $\phi$  is the horizontal variation of magnetic field. Hence, the radiation pattern can be written as,

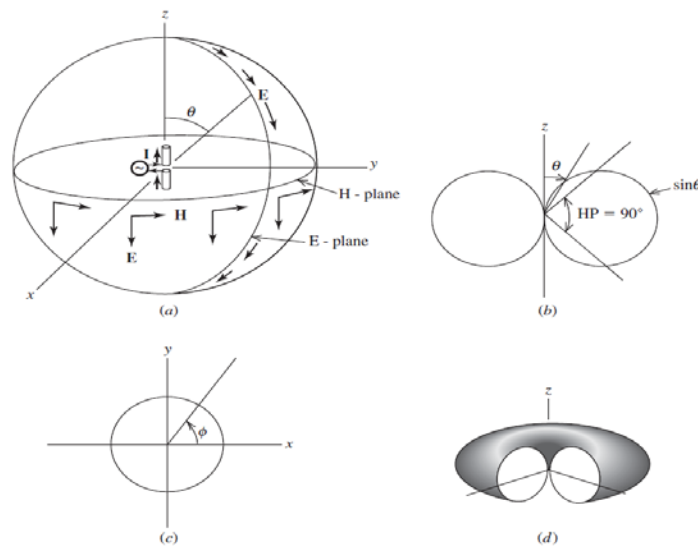
$$U = r^2 \times \frac{1}{2} \frac{|E_{\theta}|^2}{Z_0} = \frac{Z_0}{2} \left( \frac{KI(0)L}{4\pi} \right)^2 \sin^2 \theta \quad (2.10)$$

where,  $L$  is the length of wire,  $I (0)$  is the uniform current along the wire,  $\theta$  is the variation of electric field and  $K$  is the wave number.

Finally, radiation pattern is usually referred by its maximum value, and the maximum value can be obtained at  $\theta = \frac{\pi}{2}$ , so the above equation can be rewrite as [13],

$$\frac{U}{U_{max}} = \frac{\frac{Z_0(KI(0)L)^2}{2} \sin^2 \theta}{\frac{Z_0(KI(0)L)^2}{2}} = \sin^2 \theta \quad (2.11)$$

The radiation pattern of an ideal dipole is given as,

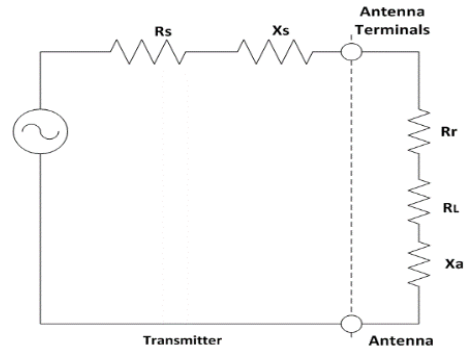


**Figure 2.5** Radiation from an ideal dipole (a) Field components (b) E-plane radiation pattern polar plot of  $|\mathbf{E}_\theta|$  or  $|\mathbf{H}_\phi|$  (c) H-plane radiation pattern polar plot of  $|\mathbf{E}_\theta|$  or  $|\mathbf{H}_\phi|$  (d) Three-dimensional plot of radiation pattern [11].

- **Radiation resistance and efficiency**

The equivalent circuit of a simplest transmitter and its antenna can be drawn as,





**Figure 2.6** Circuit of transmitting antenna.

It can be seen that, antenna resistive part consist of two impedances that is radiation resistance  $R_r$  and loss resistance  $R_l$ . Loss resistance is simply the power lost within the antenna itself due to the losses in conducting or dielectric parts of the antenna while radiation resistance provides the actual power radiated by the antenna. Therefore, radiation efficiency  $e$  of the antenna is given as [13],

$$e = \frac{\text{Power radiated}}{\text{Power accepted by antenna}} = \frac{R_r}{R_r + R_l} \quad (2.12)$$

Antenna with high radiation resistance has high radiation efficiency in comparison to the losses. Antenna impedance matching is the practice of designing the input impedance of an electrical load or the output impedance of its corresponding signal source to maximize the power transfer or minimize signal reflection from the load. Therefore, a maximum power is delivered to antenna if source and total antenna impedances are complex conjugate that is [13],

$$Z_s = Z_a^* \quad (2.13)$$

where,  $Z_s = R_s + jX_s$ ,  $Z_a = R_r + R_l + jX_a$

If the match is not ideal, then the level of mismatch can be found by the reflection coefficient  $\rho$ , that is defined as,

$$\rho = \frac{V_r}{V_i} = \frac{Z_a - Z_s}{Z_a + Z_s} \quad (2.14)$$

where,  $V_r$  and  $V_i$  are the amplitudes of the reflected waves from the antenna to the transmitter and incident from the transmitter onto the antenna terminals respectively [13].

- **Antenna effective aperture**

Generally, antennas are not lossless devices. The power received by receiving antenna is reduced to the fraction  $e_r$  of what it would be if the antenna were lossless. This is represented by defining the effective aperture.

$$A_e = e_r A_{em} \quad (2.15)$$

where,  $e_r$  is the radiation efficiency and  $A_{em}$  is maximum effective aperture which is the lossless case. Hence, the available power at receiver antenna is given as,

$$P_A = S A_e \quad (2.16)$$

where  $S$  is the incident power density at receiver antenna. This equation 2.16 states that, the receiver side antenna act to convert the incident power density to power delivered to the load. It is important to note that the relationship developed for receiving antenna is also applicable to transmitting antenna.

According to the equations developed in [11], the received power  $P_r$  by receive antenna which is placed at distance  $R$  from transmission antenna is given as,

$$P_r = P_t \frac{G_t G_r \lambda^2}{(4\pi R)^2} \quad (2.17)$$

where  $P_t$  is the transmitted power by transmitter antenna,  $G_t$  and  $G_r$  are the power gain of transmit and receive antenna respectively and  $\lambda$  is the wavelength. This equation 2.17 is called Friis transmission equation and is very useful to calculate the signal power levels in communication link. This equation assumes that, the transmitting and receiving antennas are matched in impedance to their connected transmission lines and have the identical polarization in both transmit and receive antennas.

- **Radar cross-section**

Radar cross-section (RCS) is a measure of object's detection level with a radar. A larger RCS demonstrates that an object will be detected easily.

Let us consider an airplane is the target of a radar and transmitting and receiving antennas are forming monostatic radar system, and are pointed such that the pattern maxima is directed toward the target. The power density incident on the target has been derived in [11],

$$S^i = \frac{P_t}{4\pi R^2} G_t = \frac{P_t A_{et}}{\lambda^2 R^2} \quad (2.18)$$

The power intercepted by the target is proportional to the incident power density, so

$$P^i = \sigma S^i \quad (2.19)$$

where,  $\sigma$  is the radar cross section in  $m^2$

The incident power  $P^i$  does not scatter isotopically but for the simplicity, only the power scattered in the direction of receiver has been considered. It is also considered that, the target scatters isotopically. Hence, the power density arriving at the receiver can be written as,

$$S^s = \frac{P^i}{4\pi R^2} \quad (2.20)$$

The power available at the receiver according to 2.16 is given as,

$$P_r = A_{er} S^s \quad (2.21)$$

Combining the above four equations (2.18), (2.19), (2.20), (2.21) gives,

$$P_r = A_{er} \frac{\sigma S^i}{4\pi R^2} = P_t \frac{A_{er} A_{et} \sigma}{4\pi R^4 \lambda^2} \quad (2.22)$$

which is known as radar equation, this equitation can be written as,

$$P_r = P_t \frac{\lambda^2 G_t G_r \sigma}{(4\pi)^3 R^4} \quad (2.23)$$

If transmitting and receiving antennas are identical then,  $G_r G_t = G^2$

$$\sigma = \frac{4\pi R^2 S^s}{S^i} \quad (2.24)$$

That is, the ratio of  $4\pi$  times the radiation intensity  $R^2 S^s$  in the receiver direction to the incident power density from the transmitter direction.

- **Directivity**

Antenna does not radiate uniformly in all directions, the variation of the intensity with direction in space is described by the directivity function  $D(\theta, \phi)$  for the antenna. Therefore, directivity can be defined as, "The ratio of the radiation intensity in a given direction from the antenna to the radiation intensity averaged over all directions". Therefore, it can be expressed as [15],

$$D(\theta, \phi) = \frac{\text{Power radiated per unit solid angle}}{\text{average power radiated per unit solid angle}} \quad (2.25)$$

- **Gain**

The gain of an antenna is defined in similar manner as directivity except that the total input power to the antenna rather than the total radiated power is used as the reference. The difference is the measure of efficiency of the antenna that is,

$$P_r = \eta P_{in} \quad (2.26)$$

where  $\eta$  is the efficiency,  $P_{in}$  is the total input power, and  $P_r$  is the total radiated power. Following this, the gain of antenna can be expressed as,

$$G(\theta, \phi) = 4\pi \frac{\text{Power radiated per unit solid angle}}{\text{input power}} \quad (2.27)$$

Gain of an antenna is more important parameter in practice than directivity because the gain describes how well the antenna converts input power into radio waves headed in a specified direction [15].

- **Input impedance**

The input impedance of an antenna is defined as the ratio of the voltage to current at pair of terminals of the antenna. The imaginary part of the impedance represents power that is stored in the near field of the antenna while the real part of the antenna impedance represents the power that is either radiated away or absorbed within the antenna [17].

$$Z_A = R_A + jX_A \quad (2.28)$$

- **Return loss**

The input impedance of antenna should be matched to the source impedance. If both the impedances are 100% matched then total input power is transferred to the output but if both are not matched, then some part of the transmitted power will be reflected back. This reflected power with respect to the input or incident power is called the return loss of the antenna [17].

$$RL(dB) = -20 \log |\Gamma| \quad (2.29)$$

where,  $\Gamma$  is the reflection coefficient.

## 2.6 Types of antennas

There are several kinds of antennas. These can be broadly classified into different categories but in general, antenna is a passive component that can radiate and receive EM waves from the space

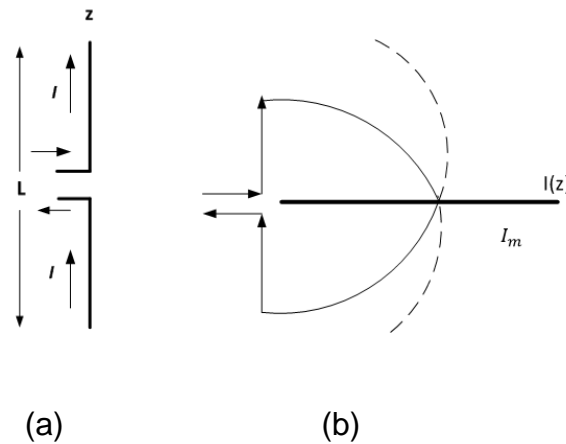
surrounding it. Antennas have the same kind of properties whether in transmit or in receive mode. Following section will explain some basic type of antennas.

### 2.6.1 Wire antennas

Wire antennas are the oldest and most common kinds of antennas because these can be commonly seen in automobiles, buildings, ships, aircraft, and spacecraft. There are numerous shapes of wire antennas such as dipole, folded dipoles, loop, and helix [10].

- **Straight wire dipoles**

The most common form of dipole is, two symmetrical straight rods or metal wires oriented end to end on the same axis. Dipoles are resonant antennas meaning that, the elements serve as resonators that is standing wave flows back and forth between their ends. The length of the dipole elements is determined by the wavelength of the radio waves. Figure 2.7(a) shows a straight wire dipole antenna. A signal with equal but opposite magnitude is provided at the center of antenna through a two-wire transmission line [12].



**Figure 2.7** Basic dipole antenna(a) structure (b) Current distribution.

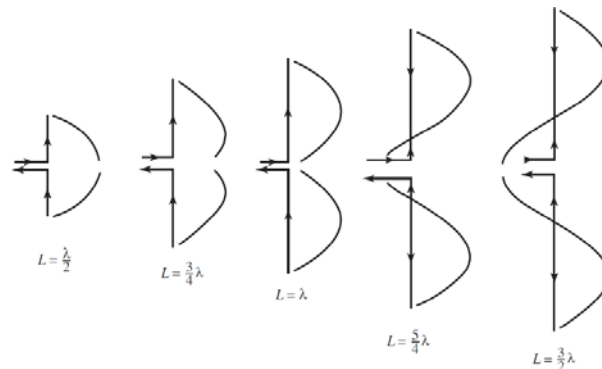
Current flows along the antenna can be represented by the following sinusoidal equation.

$$I(z) = I_m \sin \left[ \beta \left( \frac{L}{2} - |z| \right) \right] \quad (2.30)$$

where,  $|z| < \frac{L}{2}$ ,  $\beta$  is the phase constant in free space and  $I_m$  is the maximum current.

The solid lines in Figure 2.7(b) demonstrates, the factual current in the wire while the dotted lines represent the sine function. The currents in both half of antenna are flowing in the same direction that results in the radiation in space.

Figure 2.8 shows the numerous dipoles with their current distribution pattern. The superimposed sinusoidal represents the intensity of current on wire at the point  $z$ .

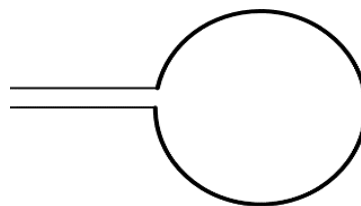


**Figure 2.8** Different lengths of dipole [12]

- **Loop antenna**

Loop antenna consists of a loop of wire with its ends connected to transmission line. There are various shapes of loop antennas that is, they may take the form of a rectangle, square, ellipse, or any other configuration. The circular loop is the most common because of its simplicity in construction.

There are small loop antennas (or magnetic loop) with a size much smaller than a wavelength. These antennas have low radiation resistance and high reactance because of that their impedance is difficult to match to a transmitter. As a result, these antennas are most commonly used as receive antennas where impedance mismatch loss can be tolerated because in receiving mode, antenna efficiency is not that important as the signal to noise ratio.



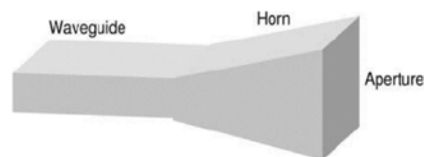
**Figure 2.9** Circular loop antenna.

As loop antennas get larger, they become better antennas because small loop antenna circumference is much smaller than one tenth of wavelength so as a result there will be constant current along the conductor. A loop antenna will be resonant (with a purely real impedance) as the perimeter of the loop approaches one wavelength in size.

As radiation and loss resistance of an antenna determine the radiation efficiency. The loss resistance of small loop antenna is generally larger than its radiation resistance that results in low radiation efficiencies in comparison to resonant antenna that has higher radiation efficiency [10,14].

### 2.6.2 Aperture antennas

Recently, aperture antennas have become more popular because of the rising demand of high frequency usage. Aperture antennas are directional antennas used at microwave frequencies and above. Aperture antenna usually consists of a waveguide and a horn. Since the antenna structure itself is not resonant, they can be used over a wide frequency range by replacing or tuning the feeding part of the antenna.



*Figure 2.10 Aperture Antenna [13].*

There are different kinds of aperture antennas, for example parabolic and horn antenna [10,14].

- **Slot antenna**

Generally, slot antenna consists of a flat surface with a slot cut out of it. The radiation pattern of slot antenna is quite similar to that of dipole antenna except the  $E$  and  $H$  fields are interchanged. These kinds of antennas can be fabricated and integrated with metallic objects with hidden appearance. Therefore, that is the reason these antennas provide reliable communication by using small transmitter [10].

- **Parabolic**

This is the most widely used high gain antenna at microwave frequencies and above. It consists of a dish-shaped metal parabolic reflector with a feed antenna at the focus. It can have some of the highest gains of any antenna type that is, up to 60 dBi but the dish must be large compared to a

wavelength. These antennas are used in point-to-point data links, satellite communication, radar applications, and radio telescopes.

- **Reflective array antenna**

In reflective array antenna, multiple directive antennas are mounted in front of a flat surface. It is done to reflect the radio waves in desired direction. This technology greatly enhances the gain. Generally, these kinds of antennas are designed to operate at VHF and UHF frequency bands.

- **Horn**

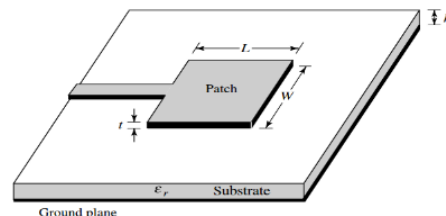
Simple antenna with moderate gains of 15 to 25 dBi consists of a flaring metal horn attached to a waveguide. These are used in radar guns, radiometers and as a feed antennas for parabolic dishes.

### 2.6.3 Antenna array

An antenna array consists of two or more antennas. The signals from different antenna elements are combined so to achieve desired performance from single antenna. Antenna arrays can be developed to increase gain, to receive the better signal (Diversity reception) and to obtain the desired radiation pattern by combing different elements having different phases. Generally, the performance of antenna is greatly increased by adding a set of antenna elements but on the other side, it increases the cost and size of antenna [13].

### 2.6.4 Microstrip antennas

Microstrip antennas or patch antennas are popular because of ease of analysis and fabrication at UHF and higher frequencies. These antennas consist of a flat rectangular sheet or "patch" of metal, mounted over a larger sheet of metal called a ground plane. The size of the antenna is usually designed according to the size of the wavelength at resonant frequency. The microstrip antennas are low profile, comfortable to planar and nonplanar surfaces, simple and inexpensive to fabricate by using modern printed-circuit technology [10,14].



**Figure 2.11** Rectangular patch antenna [10]



## 2.7 Propagation

When waves move through space, they always experience some losses in the form of reflection, diffraction and scattering due to the obstacles or different propagation media in space. These propagation losses have great impact on signal power. Therefore, to enhance the communication system, these losses are always considered in calculations so that the exact amount of power can be received at the receiver end.

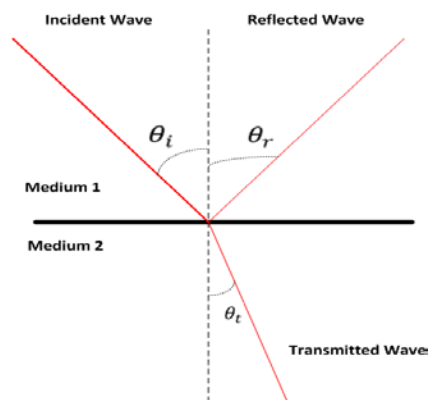
- **Reflection**

Whenever a plane wave incident onto a plane boundary between two media with different permittivity and permeability as shown in Figure 2.12, it always experiences some reflection. Incident of wave results in generation of two new waves, each wave has the same frequency as that of incident wave. The first wave reflects back into the same medium making an angle  $\theta_r$  to the normal and is called reflected wave. The second wave moves into medium 2 making an angle  $\theta_t$  to the surface normal and is called transmitted wave for example, when the wave is incident on concrete wall, the maximum wave will be reflected back and small portion of it will be transmitted but when wave is incident on conductor, the maximum wave will be transmitted while the minimum portion of it will be reflected back.

Snell's law of reflection states that,

$$\theta_i = \theta_r \quad (2.31)$$

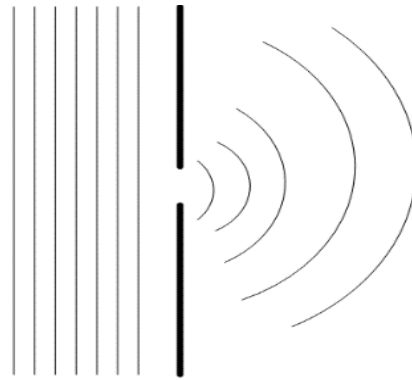
which means that, the incident angle of wave is always equal to the reflected wave [13].



*Figure 2.12 Reflection*

- **Diffraction**

Diffraction happens when a wave encounters an obstacle or a slit. It is defined as the bending of wave around the edges of an obstacle. It can only be possible, when a wave encounters an obstacle or a slit that is equivalent in size to wavelength of wave as illustrated in Figure 2.13.

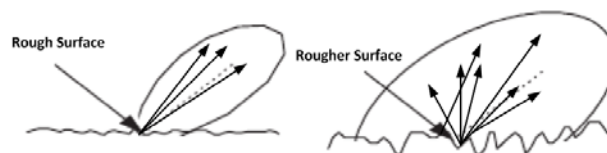


*Figure 2.13 Diffraction*

The Huygens's principle of diffraction states that every point on a wave front is a source of new spherical wave front [18].

- **Scattering**

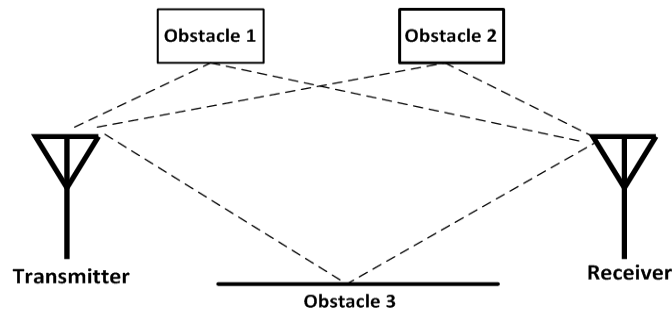
If the plane of incident surface is rough, then the incident wave will be scattered into greater number of directions depending on the level of surface roughness and the angle of incident wave in comparison to the size of wavelength. Scattering attenuates the signal energy into different scattered signals [13].



*Figure 2.14 Scattering*

## 2.8 Multipath propagation

The radio channel is the transmission medium between the transmitter and receiver in wireless communication system. Hence, the propagating signal is received at the receiver end through diffraction and reflection due to the houses, mountains, trees or any kind of obstacle between the transmitter and receiver. Due this, signal get to the receiver from transmitter through a number of different propagation paths known as multipath propagation shown in Figure 2.15. Each signaling path has different delay, phase shift and amplitude. Therefore, sometime it becomes very hard to receive the exact signal at the receiving end [18].



*Figure 2.15 Multipath propagation*

- **Delay spread**

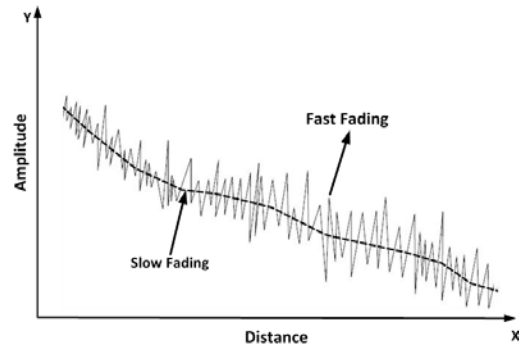
It is the delayed spreading (delayed on time scale within the specific time period) out of the received signal due to multipath fading. It is caused when same signal received by the receiver on different time intervals and delays appear due to multipath propagation [19]

- **Fading**

Fading is the attenuation of signal over propagation media due to different kinds of losses. Therefore, due to fading, less signal power level is received at the receiver end. Fading greatly depends on given radio frequency and geographical location of the propagating signal. Fading can be divided into different categories such as slow fading and fast fading [18] [19].

**Slow Fading:** Slow fading is the variation of the local mean signal level over a large area. It is also called as long normal fading.

**Fast Fading:** It is a rapid fluctuation of radio signal amplitude during a short period of time. It happens due to multipath propagation.



*Figure 2.16 Fading*

## 2.9 Path loss and link budget

The difference between the power delivered to the transmitting antenna and that obtained from the receiving antenna is known as the path loss. It includes all kinds of losses that a wave experiences during propagation from transmitter to receiver.

The amount of power that is required to deliver to a receiver across a wireless link in order that the transmitted data be successfully received is known as the link budget. Link budget calculates all kinds of losses that a wave experiences during propagation so that, the required amount of power can be received at the receiver end [18] [19].

## 3. Radio Frequency Identification Technology (RFID)

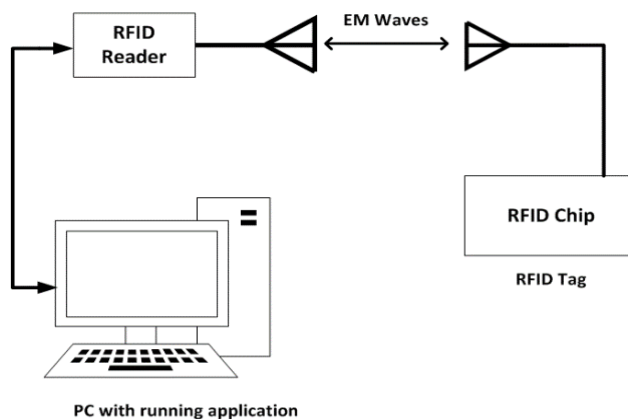
### 3.1 Introduction

In RFID system communication between tag and reader happens through electromagnetic waves. Normally, in passive UHF RFID system, each object is labelled with a tag that consists of an antenna and integrated circuit (IC) that has the object information inside memory. The reader sends a signal to make the tag active and then the information stored inside the tag is backscattered to reader and is passed to a host computer for processing [21].

The idea of radio frequency identification technology (RFID) came from the development of radar during the second world war [45]. Harry stockman was the man who first time gave the idea of communication by means of reflected power in 1948 but still work was not enough to implement the technology [45-46]. Furthermore, 1950 to 1970 many institutions and laboratories worked on it to produce a significant amount of work especially, many applications were developed for animal tracking, vehicle tracking and factory automation. Later on, tolls collecting remained the hottest area of application [45]. Hence, the development keeps continue until today, RFID has grown up for short range radio communication in health care, welfare and security purposes [1][4][5]. In this regard, passive UHF RFID tags are the most demanding area of development because of its simplicity that ultimately results in low cost. The reason is that, passive UHF tags have no battery, no crystal frequency reference, no synthesizer to create a high frequency signal, no power amplifier to amplify the synthesizer signal and no low noise amplifier to capture the reader signal. These functions are relatively expensive. Hence, their reduction greatly reduces the cost of tag manufacturing [21].

- **Components of RFID systems**

RFID system uses wireless radio communication technology to uniquely identify the tagged objects. RFID system consists of three components [24]. A tag, reader and a computer.

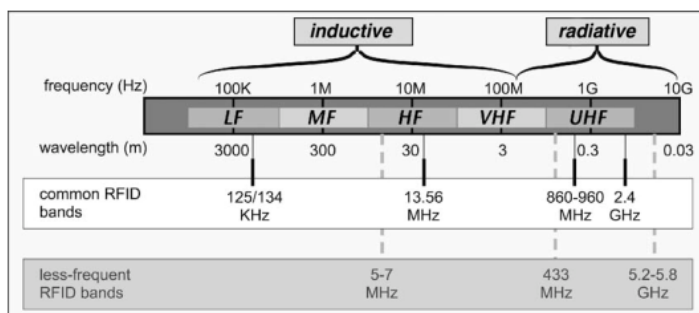


*Figure 3.1 RFID system*

RFID tags can be categorized according to frequency, power, and protocols [21]. These are extremely important implementations because the choice of frequency, power source, and protocol has fundamental effects on range, cost, and features offered to user.

### 3.2 Frequency bands for RFID

The most fundamental consideration for RFID system is the operating frequency. RFID system has different frequency bands as shown in Figure 3.2.



*Figure 3.2 RFID frequency bands [21]*

RFID data rate is directly proportional to the frequency that is low frequency bands usually have very low data rate while it increases at higher frequency bands because at high frequency, higher level of modulation can be applied to transmitting data [18] [24].

- **Read range**

Tag read range is defined as the maximum distance at which tag can be read. It could be directly

measurable either manually by installing the whole setup or through the anechoic chamber. It depends on environmental path loss through which the wave propagates, tag sensitivity and EIRP transmitted by the reader.

If the maximum read distance is limited only by the tag sensitivity, then the tag range can be calculated in an arbitrary propagation environment by solving the following link budget equation that equalizes the signal strength at the tag location to the tag power sensitivity [47].

$$P_t G_t L_{path}(d) = P_{tag} \quad (3.1)$$

where,  $P_t$  is transmitter power,  $G_t$  is transmitter gain,  $L_{path}$  is the distance and  $P_{tag}$  is the tag power sensitivity. Equation 3.1 can be derived for free space where the path loss is proportional to  $d^{-2}$  and tag range can be obtained as [47],

$$r_{tag} = \frac{\lambda}{4\pi} \sqrt{\frac{P_t G_t G_p \tau}{P_{th}}} \quad (3.2)$$

This is the fundamental tag range equation which states that tag range is directly dependent on chip threshold, power sensitivity, tag antenna gain and impedance matching between microchip and tag antenna [47].

### 3.3 Passive, semi-passive and active tags

RFID tags can be classified into different categories based on the power supplied to tag. Active tags use their own power supply to activate the microchip and that power supply can be obtained from solar cell or battery. Therefore, electromagnetic field received from reader is not necessary for the power supply to chip. These types of tags can enormously enhance the communication range if the transponder is good enough to detect the weaker signals. Semi-passive tags use both battery and backscattered signals to activate the tag's microchip [20].

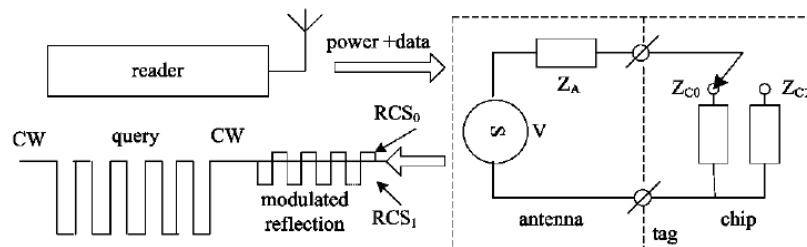
Passive tags don't have their own electrical power source. Therefore, passive tags depend on the power received from the reader [21].

- **Backscatter radio links in passive tags**

In a typical radar application, the radiation returned from the target carries the target information [48]. The communication between passive UHF RFID tag and reader follows the same procedure and starts communication by backscattering the modulated signal from the tag [50].

Passive UHF RFID systems are different from traditional wireless systems which involve active transceivers on both side of the link while on the other hand, tags are powered only by the signal from reader. Therefore, RFID readers must be intelligent enough to transmit and receive simultaneously, so that it should be able to communicate with tag. The signal from the reader carries power and command for tag and the response from tag to reader is known as backscattered signal [50].

The backscatter signal from RFID tag uses ASK (amplitude shift keying) or PSK (phase shift keying) modulation technique for communication with the reader [49]. The communication starts when the reader emits continuous wave to activate the tag. Therefore, when the tag has got enough power to run the IC, then it sends data back to the reader using its own modulation. The tag sends data back by switching its input impedance between two states and thus modulating the backscattered signal as shown in the Figure 3.3. Actually, at each impedance state, the tag presents a certain radar cross section (RCS) as a result, one of the impedance states is generally high and other is low to provide a significant difference in the backscattered signal. The variation of these impedance with power and frequency can lower down the performance of the tag. Therefore, proper impedance match between the antenna and the chip is very important in RFID systems. When impedances are matched, the power is transferred from the tag to the chip and little portion of transmitted power is backscattered [50].



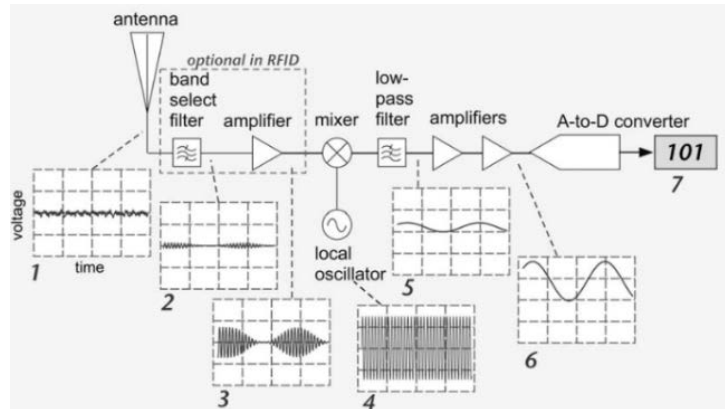
**Figure 3.3** Passive backscatter RFID system [50].

- **Reader**

RFID reader consists of a radio transmitter and receiver that work together for a reliable communication between tag and reader. Reader communicating with a passive RFID tag must always operate in full-duplex mode means that it should send a signal to tag for backscatter while listening the tag at the same time. The internal components of RFID reader consist of amplifier, oscillator, mixer, filter and analog to digital converter as shown in Figure 3.4. When the signal is fed to the RFID reader, first it passes through the band select filter that filters the signals outside of the required band and passes only the required frequency band. After the amplification of the



selected frequency band, the signal is provided to mixer from one side while another signal coming from oscillator is provided from the other side. The mixer creates the sum and difference of the two provided frequencies. Then the signal is provided to low pass filter which passes lower required frequencies to amplifier for amplification which is then converted to digital form by the analog to digital converter [21].



*Figure 3.4 UHF tag reader [21]*

### 3.4 UHF RFID microchip

RFID microchips are very important in construction of RFID tags. Impedance matching of chip with antenna, memory space, read/write sensitivity, read distance and serialization play a key role in RFID tag construction for a certain application [51]. One of the fundamental challenge in development of RFID tag is the impedance matching, so the impedance of RFID microchip and its function in different environments should be analyzed.

Unfortunately, the measurement of the IC impedance is challenging because it requires some advance equipment also the data processing with this is quite complex. To resolve the issue, some equivalent circuit model for RFID IC based on wireless measurement has been developed. Furthermore, some manufacturers, for example Alien technology, Iminj and NXP have proposed some models.

In this project NXP UCODE G2iL series RFID IC with wake-up power of  $-18\text{dBm}$  ( $15.8\ \mu\text{W}$ ) has been used that is based on parallel connection of the resistance ( $2.85\ \text{k}\Omega$ ) and capacitance ( $0.91\ \text{pF}$ ). These components enable the prediction of the realized tag antenna gain to a good degree of accuracy over the UHF frequency range of  $800\text{-}1000\ \text{MHz}$  [52].

## 3.5 The art of UHF RFID antenna design

UHF RFID tag's antenna plays a key role in overall RFID system performance factors such as overall size, read range and the compatibility with the tag objects. The design aim is to achieve the inductive input reactance required for the microchip conjugate impedance matching also to miniaturize the antenna shape. Many methods have been used some of them are listed below [53].

### 3.5.1 Methods for conjugate impedance matching

Microchip impedance depends on the input power and because the transponder includes an energy-storage stage and its input reactance is strongly capacitive. Therefore, to achieve the conjugate matching, antenna impedance should be inductive. Hence, to achieve the conjugate matching, the matching mechanisms have to be embedded within the tag's antenna layout. There are many of methods that have been developed such as T-Match, inductively coupled loop and nested slot [53].

### 3.5.2 Methods for size reduction

Most of UHF RFID tags are attached onto small objects. Therefore, the antenna geometry should be as small as possible without unacceptable degradation of radiation efficiency. Two size reduction techniques, meandering and Inverted-F structures have been successfully deployed to design RFID tags. Both structures require a single or even multiple folding of the radiating body, but the Inverted-F antennas additionally include a finite approximation of a ground plane [53].

### 3.5.3 Other designing techniques

There are some other classifications for the UHF RFID designs those include dual band, dual polarized and the new near-field UHF RFID tags [53].

- **Dual-band tags**

Multi-band operation has been deployed in antennas by using several resonant elements or by producing high order harmonics. The main target during the construction is to avoid size increase, and the tuning elements should be embedded inside the radiating element.

Recently, some dual-band design solutions have been proposed to achieve 870 MHz and 2.45 GHz or 2.45 GHz and 5.8 GHz compact multifunction transponders. The main idea is to load a

traditional tag antenna with parasitic tuning elements such as inner slots or a tuning stub.

- **Dual polarization tags**

Dual polarized tag antennas are manufactured to either decrease the reading distance by mutual orientation between the reader and tag or to receive energy and transmit back the identification information through different polarized antennas. Orthogonal slots, driving conventional patch tag and crossed dipoles are the most common deployed methods [53].

## **4. Wearable Antennas**

### **4.1 Body area network(BAN)**

IEEE 802.15 defines body area network (BAN) as:

“A communication standard optimized for low power devices and operation on, in or around the human body (but not limited to humans) to serve a variety of applications including medical, consumer electronics / personal entertainment and other” [25].

The recent standardization of WBANs (IEEE 802.15.6) provides an international standard for short range, low power and extremely reliable wireless communication within the ambient area of the human body [26].

### **4.2 Body-centric communication systems**

The growth in world's population and increment in patients with fatal diseases is becoming a fundamental problem for all health care systems around the world. On the other hand, millions of people die from diabetes, asthma, obesity, cancer, cardiovascular disease and numerous more chronic or fatal diseases every year [27] [44]. The most common issue with all current diseases is that, many people experience the symptoms and get diagnosed when it is too late. Due to these challenges, it is expected that the individual health care cost in future will drastically rise to out of common man reach.

To counter the situation, recently, wireless body area network (WBAN) consisting of various sensors has become an extremely important technology. It aims to provide health care to each individual at the advance level of personalization including diagnosis of various disease and monitoring of certain health care parameters [28] [29] [44]. WBANs may collaborate with the internet and other existing wireless technologies like, wireless sensor network (WSN), Bluetooth, wireless local area network (WLAN), wireless personal area network (WPAN), video surveillance systems and cellular networks to wirelessly communicate the immediate information [30]. Finally, it helps to monitor person's health continuously without disturbing individual's daily life activities. Moreover, individuals are free to move anywhere that is, they are not forced to stay at home or hospitals.

### **4.3 History of wearable antennas**

Wearable antennas are designed and developed to operate while being worn. In recent research, different kinds of wearable antennas have been introduced those include monopoles, planar dipoles and planar Inverted-Fs (PIFAs). Later on, a wearable patch antenna was introduced, that was based on dual band antenna designed for GSM and Bluetooth 2.4 GHz band application. The placement for antenna on the human body was on the sleeve. The antenna was fabricated on a rigid substrate but because of its small size and placement on human body, it was known as a wearable antenna. To reduce the effect of human body, manufacturer used a ground plane as an isolation between human body and antenna [31] [32].

Later on, wearable antenna technology got great importance in the consumer market. Therefore, to meet the requirement, a new type of wearable antenna made of fabric material was first time introduced in 2001 [33]. Development remained continue for the latest applications like military and safety during 2004-2007 [34] [35], so different kinds of flexible materials including electro-textile were tested and introduced. Textile study opened the door of new world where RFID tags and sensors can be made of different kinds of textile materials. Currently, embroidery and fabric based wearable antennas for UHF passive RFID tags are very popular [4][9]. Furthermore, people are also working on inkjet-printing for the fabrication of antennas on leather and different paper substrates by using silver nanoparticles as an ink material [42] [43].

### **4.3.1 Fundamental challenges during wearable antenna development**

- **Human body**

There are fundamental challenges during construction of wearable antennas. One of them arises due to the direct placement of antenna on human body because antennas that are close to the human body generally show a dramatic change in radiation efficiency in comparison to the antennas in space as human body absorbs some of the radiated energy of antenna based on different dielectric properties of biological tissues at different UHF frequencies. In a result, antenna efficiency and radiation pattern are greatly affected. Furthermore, the movement of person or change in position results in change in geometry of wearable antennas that also affects the antenna performance [6].

- **Materials**

Normally, rigid and hard materials are used for the manufacturing of antennas which are not suitable for wearable antennas. Wearable antennas have their own requirements because these antennas are used while being worn. Therefore, the wearable antennas should be light weight and should have good conductor properties. To counter the situation, textile material can be used but

still dielectric and electrical properties of textile material are not good enough to meet the requirement [36].

- **Environmental issues**

Textile features of textile antennas can readily take some moistures from air. Therefore, water can severely affect the resonance frequency and impedance of wearable antennas [8].

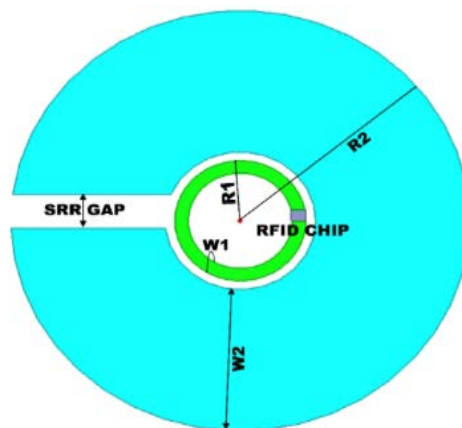
#### 4.3.2 Solving the issues of wearable antenna design

Wearable antennas when placed on human body their performance is greatly reduced. Therefore, the performance can be enhanced by giving a good isolation space between antenna and human body. Good isolation can be provided by adding conductive layer between antenna and human body [37].

Wearable antennas based on textile material can badly affect the performance of antennas due to the moisture in air which in turn badly affect the resonance frequency of antenna. Hence, the performance of antenna can be improved by choosing a better textile material for example, the studied textile material (conductive nickel and copper-plated Less EMF Shieldit Super Fabric, Cat. #A1220, sheet resistance of  $0.16 \Omega/\text{sq}$ ) gives better results in comparison to copper conductive sheet [8].

#### 4.4 Development of wearable electro-textile split ring RFID tag

Figure 4.1 shows the split ring antenna, which is developed as antenna at 915MHz frequency by using split ring structure proposed by Pendry et al. in 1999 [38].



*Figure 4.1 Developed split ring antenna.*

The smaller ring is the feed loop where RFID IC has been installed and larger one is the main radiating body where the split gap is introduced. The principle operation of the split ring antenna is that, a time varying magnetic field polarized perpendicular to the plane of the split ring resonator (SRR) induces circulating current on the feeding part resulting in the magnetic field that goes out from the inside of the feeding loop to the outside of the feeding loop. Finally, in order to cancel this magnetic field, new magnetic field is induced near the radiating part. Hence, due to the split gap in SRR an opposite directional current is generated in the radiating part. It is actually the source to radiate into the free space [38]. The SRR gap provides rather larger capacitance and together with the inductance of the ring resonates at a wavelength much longer than the size of the resonator.

At first, antenna was optimized by using copper (thickness 35  $\mu\text{m}$ ) as antenna conductor and EPDM (Ethylene-Propylene-Diene-Monomer) cell rubber foam as a substrate (thickness: 2 mm and 5mm). To measure the impact of the human body on the antenna performance, three large rectangles representing the dielectric properties of skin, fat, and muscle were introduced under the antenna structure. In the simulation, the dielectric properties of all of the biological tissues were based on the frequency-dependent four-term Cole-Cole dispersion model with the parameters provided in [39]. Table 4.1 lists the dielectric properties of the tissues at 915 MHz.

**Table 4.1** Biological tissues properties at 915MHz

Tissue	Skin	Fat	Muscle
$\epsilon_r$	41.33	5.46	55.00
$\tan\delta$	0.414	0.185	0.339

By using this model, antenna impedance and radiation efficiency were estimated in body worn configuratin. The development of the structure was based on electromagnetic (EM) modelling in ANSYS High Frequency Structure Simulator (HFSS) with the target of maximum read range at 915 MHz. Normally, the read range of passive tags is limited by the forward link operation, i.e. the efficiency of the wireless power transfer from the reader to the tag IC. Assuming free-space conditions for site-independent comparison, the obtainable tag read range at the spatial observation angles  $\phi$  and  $\theta$  of a spherical coordinate system centered at the tag is given by,

$$d_{tag}(\phi, \theta) = \frac{\lambda}{4\pi} \sqrt{\frac{\tau e_r D(\phi, \theta) EIRP}{P_{ic0}}} \quad (4.1)$$

$$\tau = \frac{4\text{Re}(Z_A)\text{Re}(Z_{ic})}{|Z_A + Z_{ic}|^2} \quad (4.2)$$

where  $\lambda$  is the wavelength of the carrier tone emitted by the reader, EIRP is the regulated equivalent isotropic radiated power,  $P_{ic0}$  is the wake-up power of the tag IC,  $e_r$  is the tag antenna radiation

efficiency,  $D$  is the tag antenna directivity, and  $\tau$  is the antenna-IC power transfer efficiency determined by the antenna and IC impedances  $Z_A$  and  $Z_{IC}$ , respectively. Equation (4.1) is a direct implication of Friis' simple transmission equation whereas (4.2) follows from simple circuit analysis where generator with internal impedance of  $Z_A$  is connected to a load  $Z_{IC}$ .

In this project, all the read range results correspond to  $EIRP = 3.28$  W (emission limit e.g. in European countries) in the direction perpendicular to the antenna surface away from the body. Since the directivity of the split ring antenna remains relatively constant regardless of the exact antenna geometry, the main target in the antenna optimization was good complex-conjugate impedance matching between the antenna and the IC and as high as possible radiation efficiency in the body-worn configuration. The dimensions of the developed antenna are listed in Table 4.2 and Figure 4.2. shows the fabricated copper based split ring RFID tag.

**Table 4.2** Geometrical dimensions of antenna in mm.

R1	R2	W1	W2	SRR gap	Chip gap
22.9	80	2.4	26.9	6.5	2



(a)



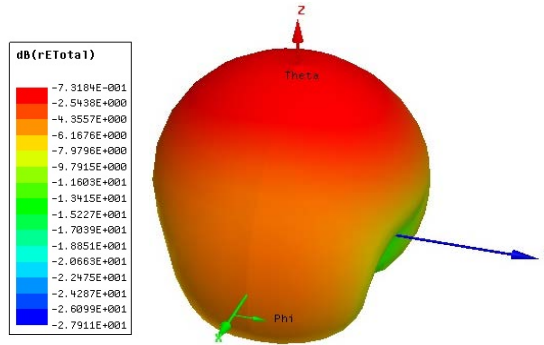
(b)

**Figure 4.2.** Copper based split ring antenna (a)EPDM substrate (b) split ring RFID tag.

- **Polarization**

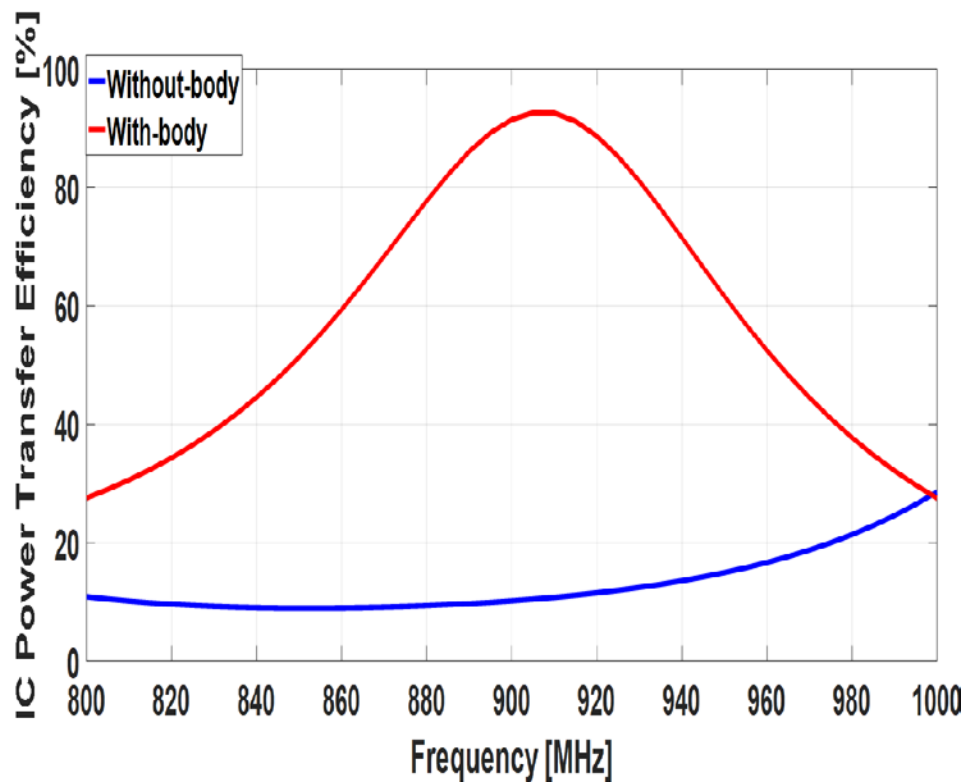
The radiation pattern of split ring antenna shows that the maximum power is in the  $z$  direction, so this antenna is linearly polarized in vertical direction.



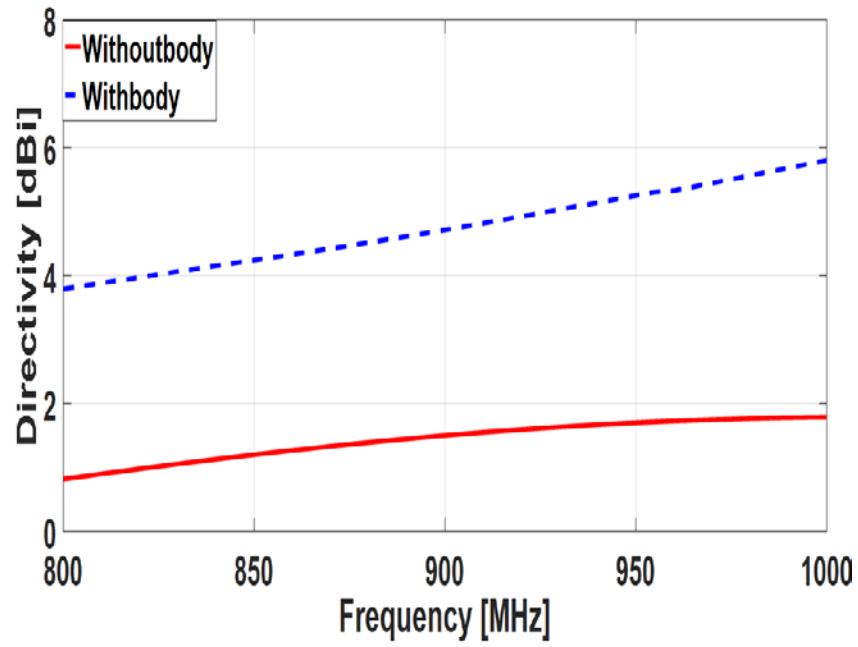


*Figure 4.3 Radiation pattern of split ring antenna.*

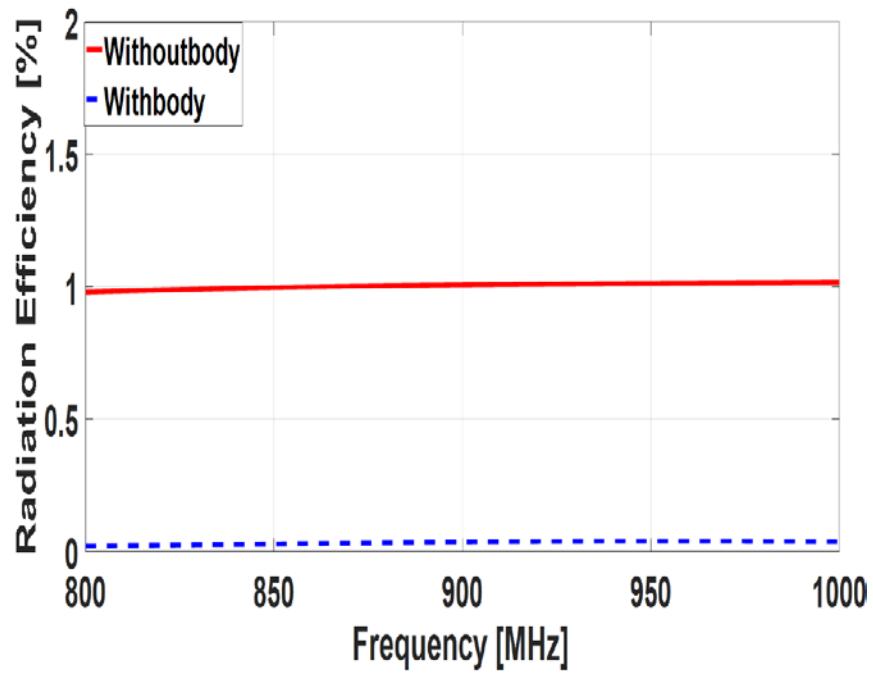
- Simulated EM properties of the tag.



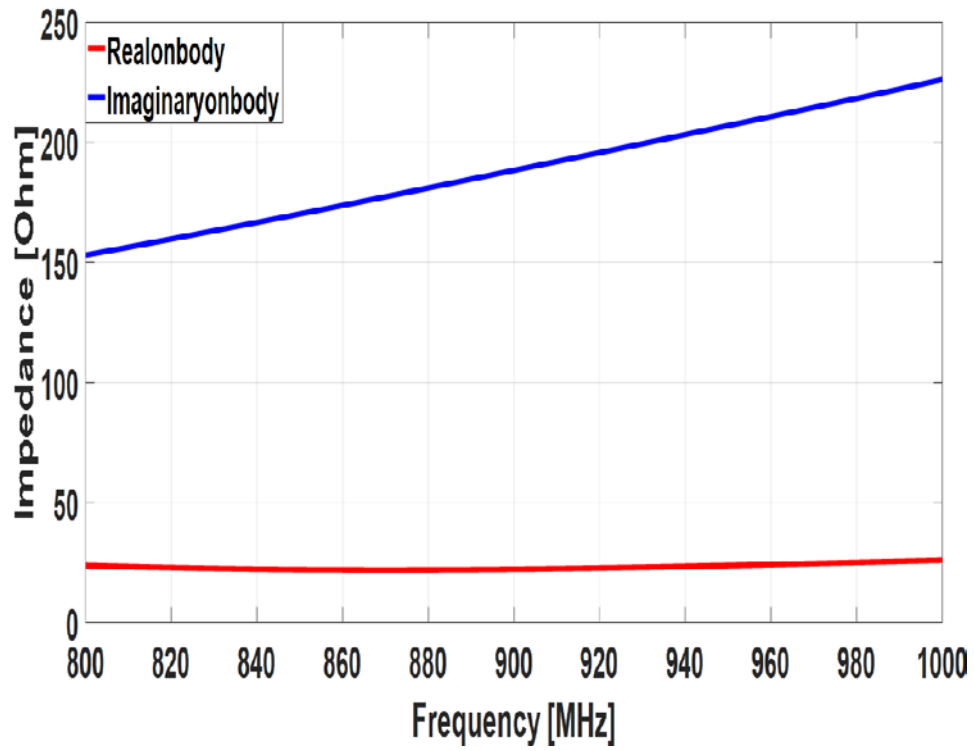
*Figure 4.4 IC power transfer efficiency*



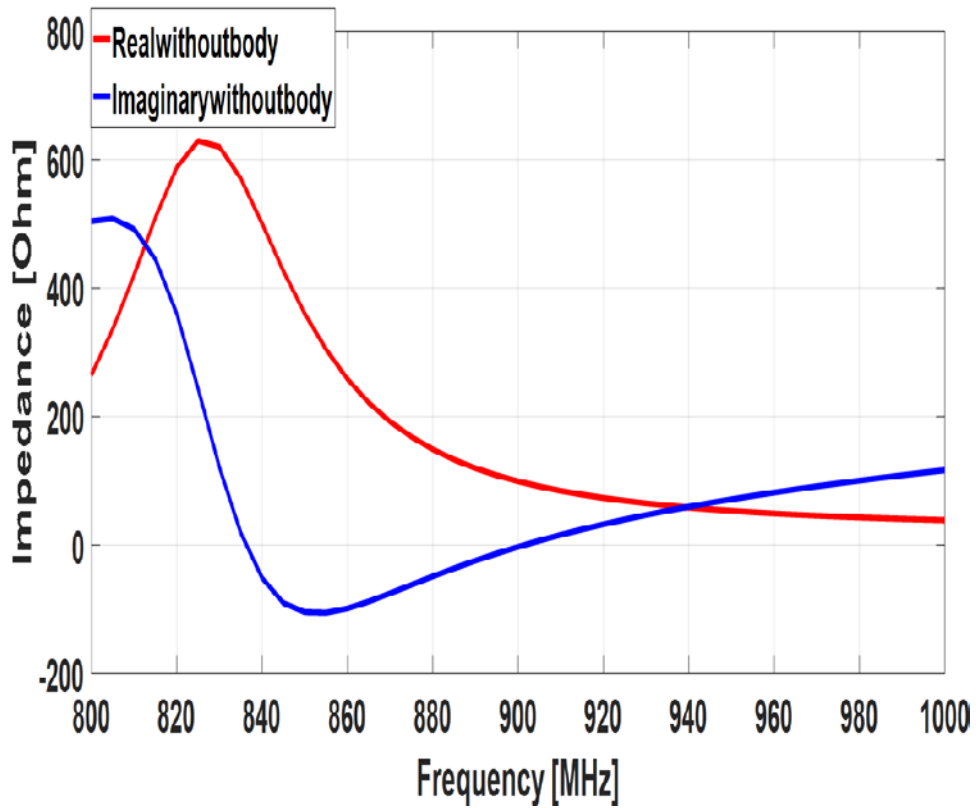
*Figure 4.5 Directivity*



*Figure 4.6 Radiation efficiency*



*Figure 4.7 On body impedance.*

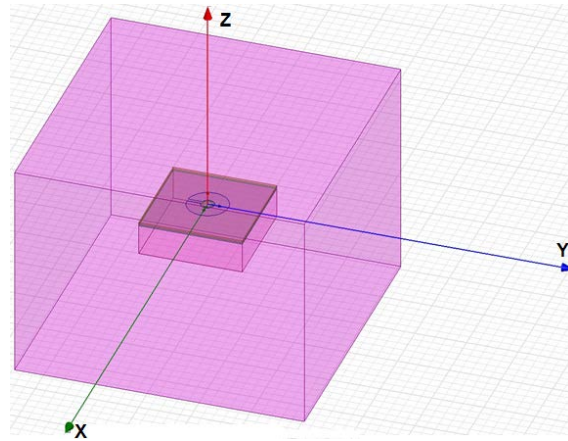


*Figure 4.8 Off-body impedance.*

Overall, the results at 915MHz frequency show that in the body-worn configuration, the antenna-IC power transfer efficiency is high, because the antenna impedance was tuned specifically in this case. However, the radiation efficiency is low due to the energy dissipation in the biological tissue. In comparison, in air the antenna-IC power transfer efficiency is low due to mistuned antenna impedance, but this negative impact is compensated by the elevated radiation efficiency. Finally, it can be noted that the presence of the body increases the antenna directivity by approximately 1.5 dB, which enhances  $d_{tag}$  in the body-worn configuration.

#### 4.4.1 Simulation steps

The outer box shown in Figure 4.9 is the radiation boundary inside which the EM field equations are solved.



*Figure 4.9 Radiation boundary.*

- **Modeling**

In order to start the modelling, an EPDM cell rubber foam substrate was created by drawing a 3D box of 2mm thickness. To incorporate the impact of body, three similar 3D boxes of skin, fat and muscles were created. On the top of substrate, split ring geometry was created by using the circular drawing blocks of ANSYS HFSS. Radiation boundary was then created by using 3D region, dimensions of this region were chosen to be half wave length wide equal in all directions.

- **Materials**

Following the modelling, the material properties were assigned. Dielectric material ( $\epsilon_r = 1.26$ ,  $\tan \delta = 0.007$ ) was assigned to EPDM substrate. The dielectric properties of biological tissues were assigned to blocks related to the human body. Vacuum material from the ANSYS HFSS material library was assigned to the boundary box of radiation.

- **Ports**

A lumped port was assigned to the rectangular box that was drawn as port at feed loop. A source impedance of  $50 \Omega$  is applied. The integration line of the lumped port is drawn in the direction of x axis.

- **Boundaries**

Layered impedance boundary (thickness of  $35\mu\text{m}$ ) was assigned to both feed loop and split ring resonator. Radiation boundary was assigned to all the faces of region.

- **Solution setup**

A driven model solution setup was used to compute the full wave solution for the created model, 915MHz was set as a solution frequency.

- **Output variables**

Custom output variables related to equivalent parallel RC circuit model of RFID chip mentioned above in equation 4.1 and 4.2 were used to calculate the read range. Finally, simulation results were plotted using these output variables.

#### 4.4.2 Simulation results and wireless testing of copper based RFID tag

The tags were tested wirelessly using Voyantic Tagformance measurement system as shown in Figure 4.10. It contains RFID reader with an adjustable transmission frequency (0.8...1 GHz) and output power (up to 30 dBm) and provides the recording of the backscattered signal strength (down to  $-80$  dBm) from the tag under test. During the test, the lowest continuous-wave transmission power (threshold power:  $P_{th}$ ) was recorded.  $P_{th}$  is the lowest power at which a valid 16-bit random number from the tag is received as a response to the *query* command in ISO 18000-6C communication standard. In addition, the wireless channel from the reader antenna to the location of the tag under test was characterized using a system reference tag with known properties, that enabled to estimate the attainable read range of the tag ( $d_{tag}$ ) versus frequency from,

$$d_{tag} = \frac{\lambda}{4\pi} \sqrt{\frac{EIRP P_{th^*}}{\Lambda P_{th}}} \quad (4.3)$$

where  $d_{tag}$  is the measured threshold power of the tag,  $\Lambda$  is a known constant describing the sensitivity of the system reference tag,  $P_{th^*}$  is the measured threshold power of the system reference tag and  $EIRP$  is the emission limit of RFID reader given as equivalent isotropic radiated power.



(a) Anechoic chamber [41].



(b) Tagformance [40].

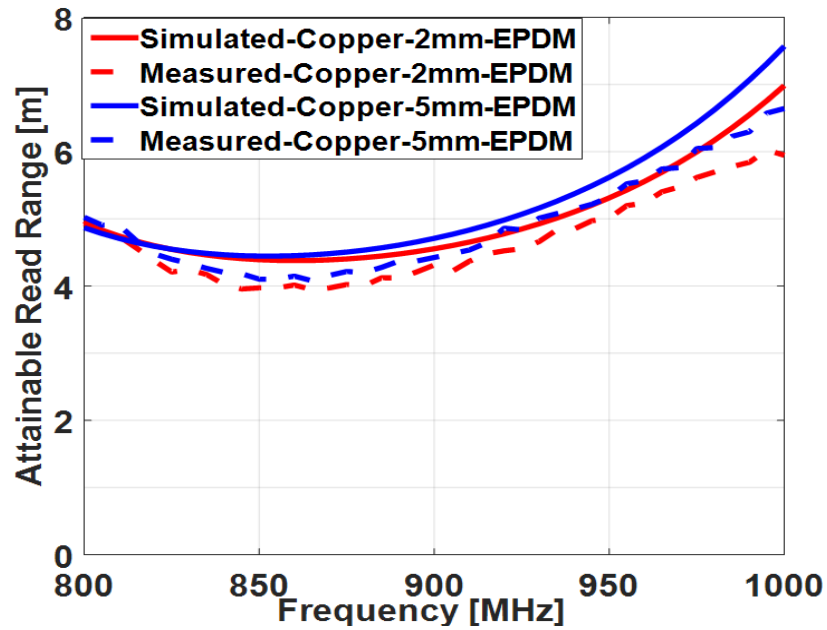


(c) Linear reference tag.

**Figure 4.10** Voyantic Tagformance measurement system.

- **Performance of copper based RFID tag in air**

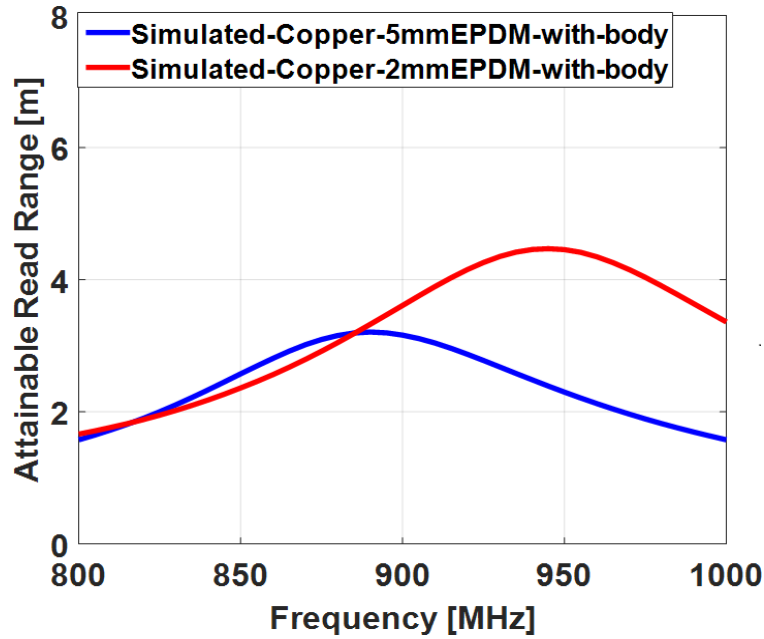
Initially, the antenna was optimized in the body-worn configuration with maximum read range at 915MHz. However, as shown by the results in Figure 4.11, the tag shows excellent results and good read range also in air. This is novel feature for wearable antennas based on a single conductor layer. As can be seen from the results, in air the substrate thickness had negligible impact on the tag's performance. Moreover, the simulated and measured results are in excellent agreement with small variations due to hand-made tolerance.



*Figure 4.11. simulated and measured attainable read range of copper based RFID tag.*

- **On-body performance of copper based RFID tag**

To confirm the performance of the tag in body-worn configuration, measurements were conducted with the tag attached to the upper back of human body. The results are shown in Table 4.3. The comparison of these results with the simulation results in Figure 4.12 confirms a good match between the measured and simulated results, also that the tag achieved a high read range in the body-worn configuration. This correlates with the fact the tag antenna was optimized on the 2 mm substrate. However, the good performance was also achieved on the 5 mm substrate, as well as in air, as explained earlier. This confirms that the tag can be attached to clothing with various thicknesses.



*Figure 4.12 On-body simulated attainable read range.*

*Table 4.3 On-body measured attainable read range [m].*

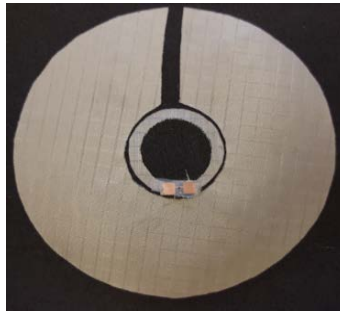
UHF Band	800	820	860	880	900	920	940	1000
2mm EPDM	1.5	2	2.3	2.7	3.8	4	4.1	3
5mm EPDM	1.2	1.9	2.5	2.9	3	2.8	2.3	1.9

#### 4.4.3 Electro-textile RFID tag

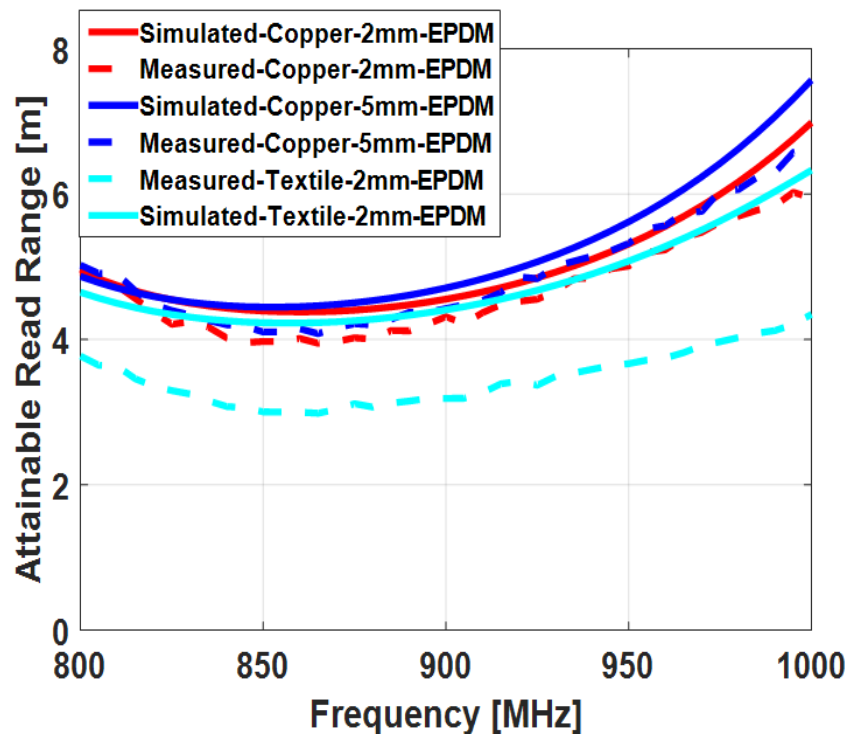
- **Performance of electro-textile based RFID tag in air.**

Finally, after analyzing the successful agreement between simulated and measured results of split ring RFID tag based on copper (thickness 35  $\mu\text{m}$ ) material. The simulated and measured results based on electro-textile (conductive nickel and copper-plated Less EMF Shieldit Super Fabric, Cat. #A1220, sheet resistance of 0.16  $\Omega/\text{sq}$ ) split ring RFID tag were analyzed. Therefore, the Figure 4.13 shows the fabricated electro-textile RFID tag and Figure 4.14 shows simulated and measured results of electro-textile based RFID tag in comparison to the copper based RFID tag in air. It can be seen that, tag based on electro-textile material has shown some variation between simulated and measured results.





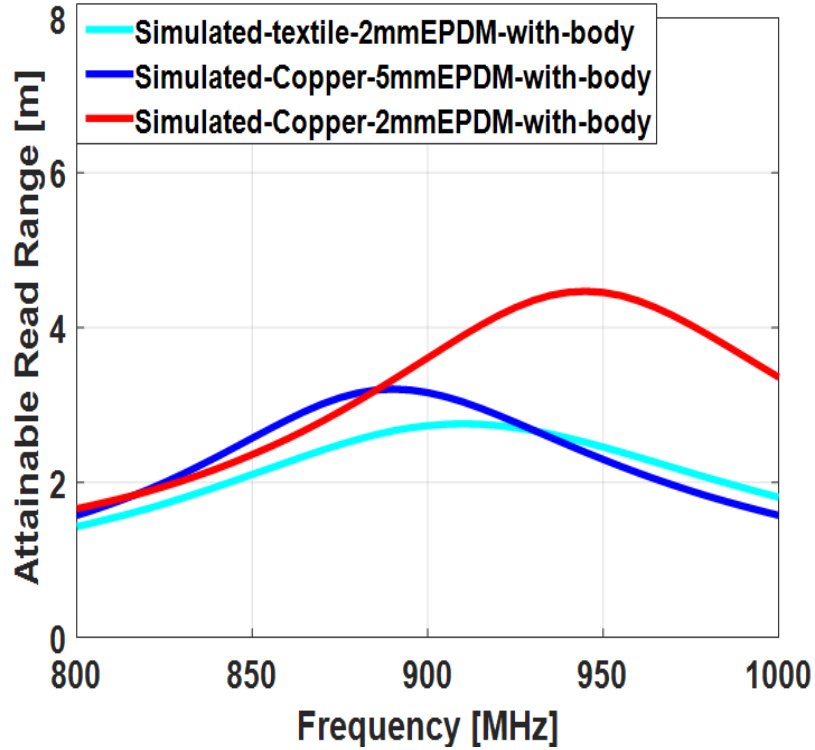
*Figure 4.13 Electro-textile based split ring RFID tag.*



*Figure 4.14 Simulated and measured results of electro-textile and copper based tags in air.*

- **On-body performance of electro-textile based RFID tag**

Then on-body performance of electro-textile tag was analyzed. Figure 4.15 shows on-body performance of electro-textile tag in comparison to copper based tag and table 4.4 shows the on-body measurement results based on electro-textile RFID tag.



*Figure 4.15 On-body simulated results of RFID tag based on electro-textile and copper material.*

**Table 4.4** On-body measured results of electro-textile RFID tag.

UHF Band	800	820	860	880	900	920	940	1000
Electro-Textile	1.8	2.5	2.4	2.3	2.5	2.8	3	3

It can be seen quite clearly from the on-body measured and simulated results of electro-textile based RFID tag that, the measured and simulated results are not in good agreement.

## PUBLICATIONS

- 1- Wearable passive UHF RFID tag based on a split ring antenna (**1<sup>st</sup> co-author**).
- 2- Comparison of wearable passive UHF RFID tags based on electro-textile dipole and patch antennas in body-worn configurations (**2<sup>nd</sup> co-author**).

## CONCLUSION

In this Master's thesis, the performance evaluation of split ring antennas using electro-textile material has been studied. Development of wearable antenna is quite challenging task due to the environmental issues, material and conductive properties of human body. So to keep that under consideration, 85% antenna IC power transfer efficiency in body-worn configuration has been achieved. Furthermore, to test, the performance in air, the influence of human body was removed and then the antenna performance was measured. It was noted from the simulated and measured results that tag based on copper material shows excellent match between measured and simulated results. Furthermore, provides excellent tag performance at variable antenna-body separations down to two millimeters. Interestingly, this is the novel feature of wearable antennas based on a single conductor layer.

Finally, to measure the performance both copper (thickness 35  $\mu\text{m}$ ) and electro-textile (conductive nickel and copper-plated Less EMF Shieldit Super Fabric, Cat. #A1220, sheet resistance of 0.16  $\Omega/\text{sq}$ ) material based split ring antennas have been analyzed by using 2mm and 5mm EPDM (Ethylene-Propylene-Diene-Monomer) cell rubber foam substrate. To proceed with, first antenna was optimized by using copper material, then an electro-textile material based antenna was manufactured. From the simulated and measured on-body/off-body results, it was noted that antenna based on copper material shows excellent match between simulated and measured on-body/off-body results. However, the simulated and measured on-body/off-body results based on electro-textile material are not in good agreement.

In future, the performance of the antenna based on different electro-textile material can be analyzed with more suitable experimental techniques. One option could be, to study the dielectric properties of different textile materials and implement them in more suitable way.

## REFERENCES

- [1] A. Plawiak-mowna, A. krawczyk, "Wireless body sensor networks -Fundamental concepts and application".
- [2] A. Arya, N. Bilandi, "A review: Wireless body area networks for health care", *International Journal of Innovative Research in Computer and Communication Engineering*, vol.2, no 4, Apr 2014.
- [3] G. V. Crosby, T. Ghosh, R. Murimi, C. A. Chin, "Wireless body area networks for healthcare: A survey", *International Journal of Ad hoc, Sensor and Ubiquitous Computing.*, vol.3, no.3 June 2012.
- [4] F. Long, X. Zhang, T. Björninen, J. Virkki, L. Sydänheimo, Yan-Cheong Chan, L. Ukkonen, "Implementation and wireless readout of passive uhf rfid strain sensor tags based on electro-textile antennas," in *Proc. European Conf. Antennas Propag.*, Lisbon, Portugal, 5 pages, 12–17 Apr.2015.
- [5] S. Amendola, G. Bovesecchi, P. Coppa, G. Marrocco, "Thermal characterization of epidermal rfid sensor for skin temperature measurements," *Proc. IEEE AP-S International Symp. Antennas Propag.*, Fajardo, Puerto Rico, USA, pp. 461–462, 26 Jun. – Jul. 1, 2016
- [6] A. Tsolis, W. G. Whittow, A. A. Alexandridis, J. C. Vardaxoglou, "Evaluation of human body phantom for wearable antenna measurements at the 5.8GHz band", *Loughborough Antennas and Propag. Conf.*, Nov 2013.
- [7] N. H. M. Rais, P. J. Soh, F. Malek, S. Ahmad, N.B.M. Hashim, P. S. Hall. "Review of wearable antenna", *IEEE - Loughborough Antenna & Propag. Conf.*, Nov 2009.
- [8] M. A. R. Osman, M. K. A. Rahim, N. A. Samurai, M. K. Elbasheer, M. E. Ali. "Textile uwb antenna bending and wet performances", *International Journal of Antennas & Propag.*, vol. 2012.
- [9] J. H. Choi, Y. Kim, K. Lee, Y. Chung, "Various wearable embroidery rfid tag antenna using electro-thread," in *Proc. of the IEEE Antennas & Propag. Society International Symp.*, San Diego, Calif, USA, pp. 1–4, July 2008.
- [10] C. A. Balanis, "Antenna Theory: Analysis and Design", 3rd ed. John Wiley & Sons, May 2005.
- [11] W. L. Stutzman, G. A. Thiele, "Antenna Theory and Design", 2nd ed. John Wiley & Sons, 1998.

- [12] W. L. Stutzman, G. A. Thiele, "Antenna Theory and Design" 3rd ed. John Wiley & Sons,
- [13] S. R. Saunders, A. Aragón-Zavala, "Antennas and Propagation for Wireless Communication Systems", 2nd ed., 2007.
- [14] J. D. Kraus, "Antennas for All Applications", 3rd ed., USA, McGraw-Hill. 2002.
- [15] R. E. Collin, "Antennas and Radio Propagation", McGraw-Hill 1985.
- [16] J. D. Kraus, D.A. Fliesch, "Electromagnetics with Applications", 5th ed., USA, McGraw-Hill.1999.
- [17] D. M. Pozar, "Microwave Engineering", Wiley, 2004.
- [18] A. F. Molisch, "Wireless Communications", 2<sup>nd</sup> ed., John Wilay & Sons. 2011.
- [19] A. Goldsmith, "Wireless Communications", Cambridge University Press, 2005.
- [20] K. Finkenzeller, "RFID Handbook" 2nd ed., 2003.
- [21] D. M. Dobkin, "The RF in RFID, Passive UHF RFID in Practice", Elsevier Inc., USA, 2008.
- [22] M. k. Lim, M. Winsper, "Exploring value-added applications of rfid systems in industry and service sectors".
- [23] L. Catarinucci, R. Colella, L. Mainetti, L. Patrono, S. Pieretti, I. Sergi, L. Tarricone "Smart RFID antenna system for indoor tracking and behavior analysis of small animals in colony cages", *IEEE Sensors Journal*, vol.14, no.4, Apr. 2014.
- [24] V. D. Hunt, A. Puglia, M. Puglia, "RFID: A Guide to Radio Frequency Identification", 2007
- [25] P. S. Hall, Y. Hao, "Antennas and propagation for body-centric wireless communications", 2006.
- [26] "IEEE standard for local and metropolitan area networks: Part 15.6: Wireless body area networks," *IEEE Submission*, Feb. 2012.
- [27] S. Movassaghi, M. Abolhasan, J. Lipman, D. Smith, A. Jamalipour, "Wireless body area networks: A survey", *IEEE Communications Surveys & Tutorials*, vol. 16, no. 3, 2014.
- [28] M. Chen, S. Gonzalez, A. Vasilakos, H. Cao, V. Leung, "Body area networks: A survey," *Mobile Networks & Applications*, vol. 16.

- [29] L. Filipe, F. Fdez- Riverola, N. Costa, A. Pereira, “Wireless body area networks for healthcare applications: Protocol stack review”, *International Journal of Distributed Sensor Networks*, Jun 2015.
- [30] G. V. Crosby, T. Ghosh, R. Murimi, C. A. Chin, “Wireless body area networks for healthcare: A survey”, *International Journal of Ad-hoc, Sensors & Ubiquitous Computing*, vol. e, no. 3, Jun 2012.
- [31] P. Salonen, J. Rantanen, “A dual band and wide-band antenna on flexible substrate for smart clothing”, *27th Annual Conf. IEEE*, vol.1, 2001.
- [32] P. Salonen, L. Sydanheimo, M. Keskilammi, M. Kivikoski, “A small planar Inverted-F antenna for wearable applications”, *The Third International Symp. on the Wearable Computers*, pp. 95-100, 1999.
- [33] P. Massey, “Mobile phone fabric antennas integrated within clothing”, *International Conf. on Antennas and Propag*, vol. 1, pp. 344-347, Apr. 2001.
- [34] C. Cibir, P. Leuchtman, M. Gimersky, R. Vahldieck, S. Mosciroda, “A flexible wearable antenna”, *International Symp. on Antennas and Propag.*, vol. 4, pp. 3589-3592, Jun 2004.
- [35] A. Jafargholi, “VHF-LB vest antenna design”, *International Workshop on Antenna Technology: Small and Smart Antennas Metamaterials and Applications*, pp. 247-250, Mar. 2007.
- [36] N. H. M. Rais, P. J. Soh, F. Malek, S. Ahmad, N.B.M. Hashim, P.S. Hall. “Review of wearable antenna”, *IEEE - Loughborough Antenna & Propag. Conf.*, Nov 2009.
- [37] T. Tuovinen, M. Berg, E. Salonen, M. Hämäläinen, J. Iinatti, “Conductive layer under a wearable uwb antenna: trade-off between absorption and mismatch losses”, *ISMICT*, 2014.
- [38] J. B. Pendry, A. J. Holden, D. J. Robbins, W. J. Stewart,” Magnetism from conductors and enhanced nonlinear phenomena”, *IEEE Trans. Microw. Theory Techn.*, vol. 47, pp. 11, Nov. 1999.
- [39] S. Gabriel, R. W. Lau, C. Gabriel, “The dielectric properties of biological tissues: III. parametric models for the dielectric spectrum of tissues,” *Phys. Med. Biol.*, vol. 41, no. 11, pp. 2271–2293, Nov. 1996.
- [40] Tagformance lite <https://voyantic.com/tagformance>.
- [41] RFID measurement cabinet [https://voyantic.com/rfid\\_meas\\_cabinet](https://voyantic.com/rfid_meas_cabinet).

- [42] H. He, L. Sydänheimo, J. Virkki, L. Ukkonen, "Experimental study on inkjet-printed passive uhf rfid tags on versatile paper-based substrates", *International Journal of Antennas & Propag.*, vol. 2016.
- [43] M. F. Farooqui, A. Shamim, "Dual band inkjet printed bow-tie slot antenna on leather," in *Proc. of 7th European Conf. on Antennas and Propag.*, Gothenburg, Sweden, pp. 3287–3290, April 2013.
- [44] J. Arboleda, J. Aedo, F. Rivera, "Wireless system for supporting home health care of chronic disease patients", *IEEE Colombian Conf. on Communications and Computing, IEEE Colcom* 2016.
- [45] J. Landt, "The history of RFID," *IEEE Potentials*, vol. 24, no. 4, pp. 8-11, Oct.-Nov. 2005.
- [46] H. Stockman, "Communication by means of reflected power," *Proc. IRE*, vol. 36, no. 10, pp. 1196-1204, Oct. 1948.
- [47] P. V. Nikitin, K. V. S. Rao, "Antennas and propagation in uhf rfid systems," *Proc. IEEE RFID International Conf.*, Las Vegas, NV, USA, pp. 277-288, 16-17 April 2008,
- [48] H. Stockman, "Communication by means of reflected power," *Proc. IRE*, vol. 36, no. 10, pp. 1196-1204, Oct. 1948.
- [49] EPC Radio-Frequency Identity Protocols, Class-1 Generation-2 UHF RFID, Version 1.1.0 (2005).  
[http://www.gs1.org/gsmp/kc/epcglobal/uhfclg2/uhfclg2\\_1\\_1\\_0-standard20071017.pdf](http://www.gs1.org/gsmp/kc/epcglobal/uhfclg2/uhfclg2_1_1_0-standard20071017.pdf)
- [50] Z. Tang, Y. He, Z. Huo, B. Li, "The effects of antenna properties on read distance in passive backscatter rfid systems", in *Proc. International Conf. on Networks Security, Wireless Communication and Trusted Computing*, 2009.
- [51] Alien technology, <http://www.alientechnology.com/products/ic/>
- [52] T. Björninen, L. Sydänheimo, L. Ukkonen, "Development and validation of an equivalent circuit model for uhf rfid ic based on wireless tag measurements", *34<sup>th</sup> Annual symp. of Antenna Measurement Techniques Association*, pp. 480-485, Oct 2012.
- [53] G. Marrocco, "The art of uhf rfid antenna design: impedance-matching and size-reduction techniques," *IEEE Antennas Propag. Mag.*, vol. 50, no. 1, pp. 66-79, Feb. 2008.