



TAMPEREEN TEKNILLINEN YLIOPISTO  
TAMPERE UNIVERSITY OF TECHNOLOGY  
*Julkaisu 535 • Publication 535*

Abdelmonaem Lakhzouri

## **Channel Estimation and Mobile Phone Positioning in CDMA Based Wireless Communication Systems**



Tampereen teknillinen yliopisto. Julkaisu 535  
Tampere University of Technology. Publication 535

Abdelmonaem Lakhzouri

## **Channel Estimation and Mobile Phone Positioning in CDMA Based Wireless Communication Systems**

Thesis for the degree of Doctor of Technology to be presented with due permission for public examination and criticism in Tietotalo Building, Auditorium TB104, at Tampere University of Technology, on the 3rd of June 2005, at 12 noon.

Tampereen teknillinen yliopisto - Tampere University of Technology  
Tampere 2005

ISBN 952-15-1368-3 (printed)  
ISBN 952-15-1826-X (PDF)  
ISSN 1459-2045

## ABSTRACT

One of the most popular techniques for accurate mobile positioning is based on the Time of Arrival (TOA) as a ranging metric. The accuracy of measuring the distance using TOA is sensitive to the multipath condition between the mobile station and the network access point. Generally speaking, multipath delays caused by distant reflectors have a relatively large delay spread, with more than one chip interval between different paths. Paths may also arrive at sub-chip delay intervals, generating closely spaced multipaths that introduce significant errors to the Line-Of-Sight (LOS) path delay and gain estimation. In 3G mobile communication systems where the Code Division Multiple Access (CDMA) technique is used as multiple access method, the need to estimate different arriving paths is a crucial task not only for the proper functioning of the CDMA receivers, but also for different emerging applications based on mobile phone positioning.

When the radio signal is transmitted through a wireless channel, the wave propagates through a physical medium and interacts with physical objects and structures, such as buildings, hills, trees, moving vehicles, etc. The propagation of radio waves through such an environment is a complicated process that involves diffraction, refraction, and multiple reflections. Therefore, the mobile channel can be divided into LOS signal and Non-Line of Sight (NLOS) components depending on the physical obstruction between the transmitter and the receiver. Also, the speed of the mobile impacts how rapidly the received signal level varies as the mobile terminal moves.

The results presented in this thesis are focused around three main themes. The first theme considers the development of signal processing techniques for channel estimation in downlink Wide-band CDMA (WCDMA) system. The estimation of both delays and channel coefficients of all detectable paths is considered. Many of the studied algorithms are derived from the Maximum-Likelihood (ML) theory. Nevertheless, these algorithms can be classified into two categories. The first one is based on the Bayesian theory where prediction and estimation stages are used such as the case of Kalman filtering based algorithms. The second category is based on a feedforward approaches such as the deconvolution methods, and the nonlinear operator based estimation. The scenarios of overlapping paths are emphasized and several solutions are presented to treat this situation. Enhancement of the estimation of the first arriving path via interference cancellation schemes is also discussed.

The second theme treats the problem whether the first estimated arriving path corresponds to the LOS or NLOS component. Here different approaches are used. First, the channel-statistics-based decision is explored. This approach uses the history of the range measurements to draw the amplitude distribution of the first arriving path. The second approach is based on estimating the Rician distribution parameters.

The third theme considers the analysis of real measurement data collected in typical urban environment. This part is tended to the understanding of the mobile channel behavior when mobile positioning applications is kept as the key issue.

The first part of this thesis is dedicated to signal processing algorithms for channel estimation in downlink WCDMA systems. In this part two classes of algorithms are presented. The first one is based on the feedback approach where Kalman filtering theory is extensively used. The focus here is on the joint estimation of multipath delays and complex channel coefficients. The second class of algorithms is based on the feedforward approach where different algorithms such as the deconvolution algorithms are presented and studied.

Here the focus is more on the multipath delay estimation and on the impact of bandlimiting pulse shapes, such as the Root Raised Cosine (RRC) filter used in WCDMA system. These techniques are also used for deriving different schemes for interference cancellation, which help in resolving the multipath components. In this part, several important enhancements to existing algorithms are introduced, and the performance of different channel estimation methods are investigated in the WCDMA downlink context, where the RRC pulse shaping poses difficult challenges to accurate channel estimation.

The second part of this thesis is directly related to the mobile positioning applications, where the delay of the direct line-of-sight signal is generally used to compute the mobile position. Here, two important topics are investigated. The first one is related to LOS detection based on the link-level channel estimation between the Mobile Station (MS) and the Base Station (BS). Two novel techniques are presented to decide whether the first arriving path is the LOS or NLOS component. The second topic is the analysis of real measurement data collected in typical urban environment, that can be helpful for choosing the positioning methods in cellular systems.

The thesis includes a collection of eight original publications that contain the main results of the author's research work.

# Preface

**In an interview with C. E. Shannon, the father of information theory, published in IEEE Comm. Magazine, 1984, Shannon speaks to R. Price about his thoughts on Pseudo Code Division Multiple Access:** *"...it seemed like a very democratic way to use up the coordinates that you have, and to distribute the cost of living, the noise, evenly among everyone. The whole thing seemed to have a great deal of elegance in my mind, mathematically speaking, and even from the point of view of democratic living in the world of communications."*

**R. Price commented :**

*"...But, in those days, I guess nobody was interested that much in "democracy". Now that the spectrum has gotten more crowded, I can see what you mean by "democracy".*

**... Shannon adds:**

*"I love that part of the idea. More and more people can come, and they would all pay equally, so to speak..."*

The research work for this thesis has been carried out during the years 2000-2004 at the Institute of Communications Engineering (formerly Telecommunications Laboratory) of Tampere University of Technology in the research projects "Advanced Transceiver Architectures and Implementations for Wireless Communications", "WCDMA Channel Estimation for Positioning" and "Advanced Techniques for Mobile Positioning".

I always feel that I am a lucky person, and I am grateful to be able to work with my adviser, Prof. Markku Renfors to whom I express my sincere and deep gratitude for his permanent guidance, valuable support, patience, and encouragements throughout many years of this research.

I would like to express my thanks to Prof. Jari Iinatti from the Telecommunications Laboratory, University of Oulu and Prof. Risto Wichman from the Signal Processing Laboratory, Helsinki University of Technology, the reviewers of this thesis, for their valuable and constructive feedback.

I owe special thanks to my colleague and co-author Dr. Elena-Simona Lohan for the fruitful and numerous technical discussion and for all the work done together. Also I want to express special thanks to Dr. Ridha Hamila for his continuous technical support and his friendship.

Distinguished thanks goes to all my present and former colleagues at ICE for the great work atmosphere. In particular, I want to thank Dr. Djordje Babic, Dr. Jukka Rinne, Tero

Ihalainen, Tobias Hidalgo Stitz, Juha Suviola, Adina Burian, Elina Pajala, Yang Yuan, Ali Hazmi, and Tuomo Kuusisto.

I am also grateful to Prof. Moncef Gabbouj, Prof. Jarmo Takala, Prof. Jari Nurmi, Prof. Tapani Ristaniemi, and Prof. Jarmo Harju for their various technical comments and help. I want to thank also all the group in the project "Advanced Techniques for Mobile Positioning" for the fruitful discussions and comments.

I would like to express my thanks to Seppo Turunen, Ilkka Kontola, Dr. Jari Syrjärinne, Harri Valio, and Samuli Pietilä from Nokia Mobile Phones, Tampere for their valuable discussions and comments during the course of "WCDMA Channel Estimation for Positioning". I would like to thank also Kennett Aschan from Nokia Research Center, Helsinki for his help and support with WCDMA measurement data analysis. Special thanks goes also to Juha Roström, Ilkka saastamoinen and all the other staff of u-Nav Micro-electronics for their help and support during the measurement campaigns for indoor channel modeling in the project "Advanced Techniques for Mobile Positioning".

Special thanks are also due to Tarja Erälaukko, Sari Kinnari, Elina Orava, and to Ulla Siltaloppi for their kind help with practical things.

This thesis was financially supported by the Academy of Finland, Tekes, Nokia Foundation and by Tampere Graduate School in Information Science and Engineering (TISE), which are gratefully acknowledged. I also wish to express my thanks to Dr. Pertti Koivisto, the TISE coordinator, for his help in practical matters.

I am grateful to all my friends in Finland, in Tunisia, in France, in Germany and in Honk-Kong, and to the small Tunisian community in Tampere for their support and care. Distinguished thanks goes to Mohamed Maala, Faouzi Alaya Cheick, Mejdi Trimeche, Satu Lassila, family Gabbouj, and family Hammouda.

And finally, I want to express my deepest gratitude to my parents, to my brothers and sisters, and to the small kids for their love and endless support. Warm thanks goes to Dija Jaabiri who lighted my way with her support and love.

ABDELMONAEM LAKHZOURI

*Tampere, May 17, 2005*

# Contents

<b>Preface</b>	<b>iii</b>
<b>List of Publications</b>	<b>ix</b>
<b>List of Symbols and Acronyms</b>	<b>xi</b>
<b>1 Introduction</b>	<b>1</b>
1.1 Scope of the thesis . . . . .	3
1.2 Thesis organization . . . . .	4
<b>2 Radio Channel and Signal Models</b>	<b>7</b>
2.1 Radio Channel model . . . . .	7
2.2 DS-CDMA Signal model . . . . .	10
<b>3 Mobile Positioning</b>	<b>13</b>
3.1 Motivation . . . . .	13
3.2 Overview of Existing Position Location Systems . . . . .	13
3.2.1 Satellite-Based Positioning Technology . . . . .	14
3.2.2 Cellular Network-Based Positioning . . . . .	16
3.2.3 Problems and Challenges in Mobile Positioning . . . . .	17
3.3 Fading distributions in LOS/NLOS propagation . . . . .	18
<b>4 Channel Estimation Algorithms</b>	<b>21</b>
4.1 Introduction . . . . .	21
4.2 Bayesian Approach For Channel Estimation . . . . .	22
4.2.1 Joint Channel Estimation . . . . .	23
4.2.2 Extended-Kalman-Filter Based Estimation . . . . .	24
4.2.3 Particle Filter Based Estimation . . . . .	25



4.3	Feedforward Approach . . . . .	26
4.3.1	Deconvolution-Based Multipath Delay Estimation . . . . .	27
4.3.2	Subspace Based Multipath Delay Estimation . . . . .	27
4.3.3	Teager-Kaiser Based Multipath Delay Estimation . . . . .	28
4.4	Inter-cell Interference Cancellation . . . . .	29
4.5	Implementation Aspects of CDMA Receivers . . . . .	31
4.5.1	Structure of Wireless Transceiver . . . . .	31
4.5.2	DSP Based Implementation of Channel Estimation Algorithms . . . . .	32
<b>5</b>	<b>LOS Detection and Channel Modeling Studies</b>	<b>35</b>
5.1	Introduction . . . . .	35
5.2	Link-Level LOS Detection . . . . .	36
5.2.1	Curve Fitting Based Approach . . . . .	36
5.2.2	Rician Factor Based Approach . . . . .	37
5.3	Mobile speed estimation . . . . .	38
5.4	Measurement data analysis for Mobile positioning . . . . .	39
5.5	Related work . . . . .	40
<b>6</b>	<b>Summary of Publications</b>	<b>45</b>
6.1	General . . . . .	45
6.2	Overview of the publication results . . . . .	46
6.3	Author's Contributions to the Publications . . . . .	47
<b>7</b>	<b>Conclusions and Further Work</b>	<b>49</b>
7.1	Further Work and Directions . . . . .	51
	<b>References</b>	<b>53</b>

# List of Figures

2.1	The wireless channel multipath phenomenon. . . . .	8
3.1	GPS and Galileo Frequency Baseline . . . . .	14
3.2	Assisted-GPS concept. . . . .	15
3.3	Examples of Rician PDFs for different Rician parameters. Rayleigh distribution for $K \sim 0$ . . . . .	19
3.4	Examples of Nakagami- $m$ PDFs for different $m$ parameters. Rayleigh distribution for $m \sim 1$ . . . . .	19
4.1	Block diagram of recursive Bayesian estimation algorithms. . . . .	22
4.2	Teager-Kaiser energy for two closely-spaced paths when rectangular a and RRC pulse shaping was used. Noise free case. . . . .	29
4.3	Block diagram of intercell interference cancellation scheme. . . . .	30
5.1	Four snapshots of the wireless channel impulse response from the city center of Helsinki. . . . .	40
5.2	Baseband PSD of two BOC-modulated signals. . . . .	41
5.3	Examples of the autocorrelation functions of BOC waveforms with 2 closely spaced paths for $N_{BOC} = 2$ . . . . .	42
5.4	Deformation of an Early-minus-Late discriminator by the influence of an overlapping multipath. Left: BPSK modulation, the correlator spacing between early code and late code is 0.5. Right BOC modulation with $N_{BOC} = 2$ , the correlator spacing between early code and late code is 0.05. . . . .	42
5.5	Snapshot of the correlator output at 2 time instants in indoor propagation. Signal coming from GPS satellite. Case of 2 distant paths. . . . .	44
5.6	Snapshot of the correlator output at 2 time instants in indoor propagation. Signal coming from GPS satellite. Case of 2 overlapping paths. . . . .	44



# List of Publications

- [P1] A. Lakhzouri, E. S. Lohan, R. Hamila and M. Renfors, "Solving Closely Spaced Multipaths Via Extended Kalman Filter in WCDMA Downlink Receivers," in *Proc IEE European Personal Mobile Communications Conference, EPMCC'03*, Glasgow, UK, March 2003, pp. 271–275.
- [P2] A. Lakhzouri, E. S. Lohan and M. Renfors, "EKF Based LOS Estimation With Intercell Interference Cancellation for WCDMA Positioning," in *Proc. IST Mobile and Wireless Communications Summit, IST'03*, Aveiro, Portugal, June 2003, pp. 573–577.
- [P3] A. Lakhzouri, E. S. Lohan and M. Renfors, "Estimation of Closely Spaced Paths Via Particle filters for WCDMA Positioning," in *Proc IEEE International Symposium on Control Communications, and Signal Processing, ISCCSP'04*, Hammamet, Tunisia, March 2004, pp. 791–794.
- [P4] A. Lakhzouri, E. S. Lohan and M. Renfors, "On the Programmable Implementation of Particle filters in WCDMA Positioning," in *Proc. IST Mobile and Wireless Communications Summit, IST'04*, Lyon, France, June 2004, pp. 248–252.
- [P5] A. Lakhzouri, E. S. Lohan and M. Renfors, "Constrained Deconvolution Approach With Intercell Interference for LOS Estimation in WCDMA Positioning," in *Proc. IEEE International Conference on Communications, ICC'04*, Vol. 5, Paris, France, June 2004, pp. 2563–2567.
- [P6] R. Hamila, A. Lakhzouri, E. S. Lohan, and M. Renfors, "A Highly Efficient Generalized Teager-Kaiser-Based Technique for LOS Estimation in WCDMA Positioning," in *EURASIP Journal on Applied Signal Processing*, Vol. 5, April 2005, pp. 698–708.
- [P7] A. Lakhzouri, E. S. Lohan, R. Hamila and M. Renfors, "EKF Channel Estimation for LOS Detection in WCDMA Mobile Positioning," in *EURASIP Journal on Applied Signal Processing*, Vol. 13, December 2003, pp. 1268–1278.
- [P8] S. Lohan, A. Lakhzouri, and M. Renfors, "Statistical Properties of Urban WCDMA Channel for Mobile Positioning Applications", " *Re-submitted to the International Journal on Wireless & Optical Communications* , (IJWOC), also published as a Technical report 2 – 2005, Institute of Engineering, Tampere University of Technology, ISBN 952 – 15 – 1354 – 3.



# List of Symbols and Acronyms

## SYMBOLS

$a_l(\cdot)$	Channel path amplitude
$B_{min}, B_{max}$	Thresholds for Rician factor
$c$	The speed of light, $3 * 10^8$ m/s
$c^{(m)}$	Chips of the PN sequence, for example $c_{k,u}^{(m)}$ is the $k^{th}$ chip of BS $u$ during symbol $m$
$E_b$	Energy of a bit
$E\{\cdot\}$	Statistical expectation
$f$	Frequency
$f_D$	Maximum Doppler spread
$f_n$	System equation
$g(\cdot)$	Pulse shaping function, after the matched filtering
$g_T(\cdot)$	Transmitter filter
$g_R(\cdot)$	Receiver matched filter
$h(\cdot)$	Channel impulse response
$h_n(\cdot)$	Measurements equation
$H(\cdot)$	Frequency response of the channel
$i$	Sample index
$I_0(\cdot)$	The zero-th order modified Bessel function of the first kind
$\text{Im}\{\cdot\}$	Imaginary part
$j$	Imaginary unit ( $j = \sqrt{-1}$ )
$K$	Rician parameter
$l$	Channel index

$L$	Number of channel paths
$m$	Nakagami factor, symbol index
$n_x$	Size of $x$
$N$	Number of observation samples
$N_0$	Single-sided noise PSD
$N_{BS}$	Number of base stations
$N_s$	Number of samples per chip (oversampling factor)
$p(\cdot \cdot)$	Conditional probability density function
$p(x_0)$	Initial probability density function
$P_{LOS}$	Probability of having LOS situation
$\text{Re}\{\cdot\}$	Real part
$r(\cdot)$	Received signal
$\mathcal{R}_{u,v}(\cdot)$	The cross-correlation between the signature of the $u$ -th base station and the signature of the $v$ -th base station
$S_F$	Spreading factors
$s_u(\cdot)$	BS signature, for example $s_u^{(m)}$ is the signature of BS $u$ during symbol $m$
$t$	Continuous time variable
$T_c$	Chip interval
$T_s$	Sample interval
$T_{symp}$	Symbol interval
$\mathbf{v}$	BS index, mobile velocity
$x_k$	State parameter
$y(\cdot)$	Output of the matched filter
$y^{(n)}(\cdot)$	Measurement signal
$\delta(\cdot)$	Dirac delta function
$\delta t$	Time spacing
$(\delta\tau)_c$	Coherence time
$\beta_d$	Doppler spread
$\Omega$	Average fading power
$\Phi_{\mathbf{h}}(\cdot)$	Fading autocorrelation function
$\Phi_{\mathbf{H}}(\cdot)$	Spaced-time spaced-frequency correlation function
$\Psi_{\mathbf{h}}(\cdot)$	Delay-Doppler-spreading function
$\Upsilon_{\mathbf{H}}(\cdot)$	Doppler Power Spectrum

$\Gamma(\cdot)$	Gamma Function
$\tau(\cdot)$	Time delay (used both in continuous-time and discrete-time domains)
$\hat{\tau}(\cdot)$	Estimated time delay
$\theta_l(\cdot)$	Channel path phase
$\theta_l^s(\cdot)$	Complex channel coefficients at sample level
$\theta_l(\cdot)$	Complex channel coefficients at symbol level
$\tau_{max}(\cdot)$	Maximum delay spread of the channel
$\eta(\cdot), \tilde{\eta}(\cdot)$	Additive noises
$\mu \in [0, 1)$	Fractional interval
$(\cdot)^*$	Complex conjugation
$ \cdot $	Absolute value

## ACRONYMS

2G	2 <sup>nd</sup> Generation Wireless System
3G	3 <sup>rd</sup> Generation Wireless System
3GPP	3rd Generation Partnership Project
ACF	Autocorrelation Function
ADF	Average Duration of Fades
AFLT	Advanced Forward Link Trilateration
AGPS	Assisted Global Positioning System
ANSI	American National Standards Institute
AoA	Angle of Arrival
ARIB	Association of Radio Industries and Businesses
AWGN	Additive White Gaussian Noise
BPSK	Binary Phase Shift Keying
BOC	Binary Offset Carrier
BS	Base Station
CDMA	Code Division Multiple Access
cdma2000	IS-2000
cdmaOne	IS-95, One of the 2 <sup>nd</sup> generation systems, mainly in Americas and in Korea
CI	Cell Identity
CIR	Channel Impulse Response



CPICH	Common Pilot CHannel
CSP	Closely Spaced Paths
DL	Down Link
DLL	Delay Locked Loop
DPCH	Dedicated Physical CHannel
DSP	Digital Signal Processor
DS-SS	Direct Sequence - Spread Spectrum
DMA	Direct Memory Access
EKF	Extended Kalman Filter
EM	Expectation Maximization
E-OTD	Enhanced Observed Time Difference
ETSI	European Telecommunications Standards Institute
FCC	Federal Communications Commission
FIR	Finite Impulse Response
GNSS	Global Navigation Satellite System
GPS	Global Positioning System
GSM	Global System for Mobile Communication
GTK	Generalized Teager Kaiser
IC	Interference Cancellation
IM	Interference Minimization
IPDL	Idle Period Down Link
LCR	Level Crossing Rate
LOS	Line Of Sight
MAP	Maximum A Posteriori Probability
ML	Maximum Likelihood
MLE	Maximum Likelihood Estimation
MS	Mobile Station
MUSIC	Multiple Signal Classification
NLOS	Non-Line Of Sight
OTDOA	Observed Time Difference Of Arrival
PDF	Probability Density Function
PF	Particle Filter
PLL	Phase Locked Loop
PPS	Precise Position Service
POCS	Projection Onto Convex Sets

PRN	Pseudo Random Noise
PTS	Pearson Test Statistic
RF	Radio Frequency
RRC	Root Raised Cosine
sec	Second
SMC	Sequential Monte Carlo
SMG	Standard Mobile Group
SNR	Signal-to-Noise Ratio
SPS	Standard Position Service
SVD	Singular Value Decomposition
SWR	Software Radio
TDMA	Time Division Multiple Access
TDOA	Time Difference Of Arrival
TI	Texas Instruments
TK	Teager Kaiser
TOA	Time Of Arrival
TOT	Time Of Transmission
UKF	Unscented Kalman filter
US	United States
VLSI	Very Large Scale Integration
WCDMA	Wide band Code Division Multiple Access
WSSUS	Wide Sense Stationary with Uncorrelated Scattering



# Chapter 1

## Introduction

In the early 1970s, telecommunication was virtually synonymous to the old telephone service. The technology primarily consisted of copper wires and electro-mechanical switches. In the 1980s, telecommunication services expanded to include voiceband data modems, facsimile machines, and analog cell phones. Today, through digitization and technological convergence, telecommunication involves the transfer of a wide variety of information, such as data, speech, audio, image, video, and graphics, over wireless and wire-line channels.

Communication is the transmission of information from one point to another. The three basic elements in a communication system are a transmitter, channel, and receiver. The transmitter and receiver are usually separated in space. A channel is the physical medium that connects the transmitter to the receiver, and it distorts the transmitted signals in various ways, such as reflections, diffractions, and scattering [1]. The signal obtained at the receiver is the overlapping of multiple signals, each with different delay, phase, and attenuation that are different from one instant to another. Therefore, the transmission path between the transmitter and the receiver can vary from simple Line-of-Sight (LOS) signal to the one that is severely obstructed by buildings, mountains, or any object present in the environment. This scenario generates what is known as multipath fading.

In most terrestrial cellular communication systems, where the environment is basically urban, the LOS signal between the transmitter and the receiver is very rare or completely absent [1].

Different propagation models have been proposed in the literature to describe each situation [1], [2], [3], [4]. When the multipath fading has no direct Line-of-sight (LOS) signal, the Rayleigh model is often used. This model is used to characterize dense urban area or indoor environments. However, when direct component exists between the transmitter and the receiver, the Nakagami- $n$  distribution (also known as Rice distribution) is often used [3]. Different other models have been presented in the literature to describe specific situation of the fading propagation. We mention here the Nakagami- $q$  and Nakagami- $m$  models that have been widely used in the literature [3], [5], [6], [7]. The Nakagami- $m$  distribution, which has been used to model the indoor-mobile multipath propagation [6], [7] as well as the scintillating ionospheric radio links presented, spans the range from one sided Gaus-

sian fading ( $m = 1/2$ ) to the non-fading Additive White Gaussian Noise (AWGN) channel ( $m \rightarrow \infty$ ).

An emerging application of wireless communications, which has received a lot of attention in both media and engineering science is the tracking of mobile phones. The possibility to make reliable position estimates triggered new services, called often as location based services (LCS), that can be offered to the public with high added value.

A step towards mobile phone positioning is the channel estimation. Here, we understand by channel estimation the estimation of all relevant path delays and channel coefficients. Positioning technologies have recently been devised using either cellular network-based, mobile-based, or hybrid approaches [8], [9], [10], [11]. In Wide-band CDMA (WCDMA) networks, mobile positioning is performed based on signal delay measurements from three or more base stations (BSs). In downlink transmission, the received signal strength, when coming from a remote BS, can be quite weak, especially when the mobile terminal is close to the serving BS [3]. This situation is usually referred to as the *hearability* problem. One idea to overcome this problem, initially proposed in [12], is that each BS turns off its transmission for a well-defined period of time to let the terminals measure the other BSs within its coverage. This technique is known as Idle Period-Down Link transmission (IPDL) [13]. Hence, the estimation of the first arriving path of the distant BSs is done during these idle periods.

At the mobile terminal side, typical received WCDMA signal is composed of a sum of multiple propagation paths that may arrive at sub-chip delay intervals, generating closely spaced multipaths [1], [2], [14]. This scenario of subchip overlapping multipath propagation, causes a major degradation of the positioning accuracy [15], [16], [17]. Many techniques have been proposed in the literature to resolve closely-spaced paths. Subspace-based approaches, which have been proposed in [18], [19], [20] proved to have good performance. However, it was pointed out that these approaches such as the Multiple Signal Classification (MUSIC), suffer from high complexity of implementation in WCDMA systems. Another class of techniques applied also to resolve closely spaced multipath components is based on constrained inverse filtering methods. The best known ones are the Least Squares (LS) techniques [21], [22], [23] and the Projection Onto Convex Sets (POCS) algorithm [24], [25], [26]. We mention also the nonlinear operator based techniques such as the one presented by Hamila [27] and based on the Teager Kaiser operator. This technique showed very good capability in resolving overlapping paths in the presence of rectangular pulse shaping. However, it was shown that this method is very sensitive to bandlimiting pulse shaping, for example, when using the Root Raised Cosine (RRC) filter in WCDMA system [28]. In general, when considering the multipath estimation problem in the presence of bandlimiting filters such as the RRC filters, the challenge becomes more difficult [3], [29].

When the target is mobile positioning applications, besides to the problem of how accurate the multipath delay estimation is, the issue of whether the LOS signal is present or not is another problem. As an example, in WCDMA system, when no assistance from the Global Positioning System (GPS) is available, to compute the mobile location, simultaneous LOS components from at least 3 BSs are required. If the position was calculated using a NLOS path delayed by quarter of chip from the LOS component to compute the mobile position, an error of at least 20 m is generated. For such reasons, it is quite important to estimate with sub-chip accuracy the multipath delays and to know whether the first arriving path is LOS or NLOS signal.

## 1.1 SCOPE OF THE THESIS

The main scope of the thesis is the analysis of signal processing algorithms in the context of mobile positioning in WCDMA networks. After the Federal Communications Commission mandate, FCC-E911 docket on emergency call positioning in USA, and the coming E112 in the European Union [30], mobile phone positioning in terrestrial cellular networks has become unavoidable. The goal in this thesis is to analyze and develop further various channel estimation algorithms for downlink WCDMA receivers and to introduce new methods for estimating the presence or the absence of the LOS signal.

In this thesis, the focus is on multipath delay estimation when Raised Cosine (RC) pulse shaping is used. We develop further the existing methods for this case and we analyze their performance based on simulations and measured data.

In general, two classes of algorithms have been considered for CDMA channel estimation. Many of them are derived from the Maximum Likelihood (ML) theory:

- The first class is based on a feedback structure where prediction and update stages are considered. Here we mention the Bayesian channel estimators, such as the Extended Kalman filter (EKF) algorithm [31], [32] [33], Expectation Maximization (EM) algorithms [29], [34], and Sequential Monte Carlo (SMC) algorithms [33], [35], [36], [37], [38]. Among the feedback structures for the channel estimation, we mention also closed-loop solutions such as the Delay Locked Loop techniques, which have been widely considered in the literature [39], [40], [41].
- The second class of channel estimators is based on feedforward structures also known as open-loop solutions. This type of structure has been used in a variety of algorithms, such as those based on the ML theory [24], [26], [39], based on the deconvolution approaches [24], [25], [26] based on the non-linear operators [42], [27], and based on the subspace techniques [18], [43], [44].

In most of these earlier works, the situation of overlapping multipaths is not considered and also no bandlimiting pulse shaping is used, i.e., their performance has been reported mostly in the presence of rectangular pulse shaping. In this thesis we investigate further some of these algorithms in the context of closely-spaced paths and bandlimiting pulse shaping. First, we use the Bayesian approach to estimate jointly all the detectable paths. Here we compare different algorithms from the point of view of their performance as well as their implementation complexity. Second, we investigate the feedforward algorithms and we develop new techniques for mitigating the effects of bandlimiting pulse shaping.

The aim of this thesis is also to investigate different techniques for improving the estimation of the first arriving path delay via inter-cell interference estimation and cancellation techniques. Delay estimation in CDMA receivers with Interference Cancellation (IC) or Interference Minimization (IM) schemes have been widely proposed in the literature in the context of DLL based delay estimation [45], [46], [47], [48]. In all these techniques, the knowledge of channel coefficients and multipath delays is a pre-requisite to perform the IC or the IM schemes. Few authors addressed the problem of interference cancellation (IC) with joint estimation of the delays and channel coefficients in the context of mobile positioning [45], [46], [47], [48]. In [46] an interference cancellation scheme was proposed in the context of DLL based delay estimation, but it was assumed that the channel complex coefficients and their relative delays are *a priori* known. In [48], the channel coefficients were

computed via a ML algorithm, and the initial delay estimates were assumed to be equal to the true path delays. Basic DLL based estimation with interference cancellation scheme combined with channel coefficient estimation can give good performance in multipath environments when the path spacing is greater than 1 chip, but especially, with bandlimiting pulse shaping, they fail to estimate correctly the delays when the paths are closely spaced [28].

In this research work, we propose two parallel interference cancellation schemes in down-link transmission that estimate the interference coming from the neighboring BSs. Here, the multipath delays and complex channel coefficients are both supposed to be unknown and estimated jointly.

This thesis also aims at providing new techniques for LOS identification<sup>1</sup>. Few authors considered this issue in the literature. Most of them are using range measurement based techniques, which measure the standard deviation of the Time of Arrival (TOA) measurements [49], [50], [51]. The key point used here is that the standard deviation of the range measurements is much higher for NLOS propagation than for LOS propagation [50]. By using a priori information about the range error statistics, the range measurements made over a period of time and corrupted by NLOS error can be adjusted to values near their correct LOS values. This is because the NLOS corrupted TOA estimates are always greater than the direct TOA values [9].

In the earlier work, no detection algorithms of LOS/NLOS situations have been found and the mitigation has been made based on the assumption of NLOS/LOS cases as worst/best situations [51].

LOS identification in the WCDMA system, was also studied by analyzing real measurement data collected from a WCDMA network. The motivation behind this study is the lack of current literature dealing with channel modeling based on real field measurement data. In order to determine the mobile position in two dimensions, it is assumed that the LOS component is present from at least 3 BSs. Therefore, knowing how often LOS situations are in the real world is of utmost importance.

## 1.2 THESIS ORGANIZATION

The core of this thesis is in the area of channel estimation for mobile phone positioning applications. It is composed of six chapters and compendium of eight publications referred in the text as [P1], [P2], ..., [P8]. These include five articles published in international conferences and three articles published in international journals. The structure of the thesis is chosen so that it provides a unified framework for the problem of mobile positioning in WCDMA system, and points out the main contributions of the author. The new algorithms and results were originally presented in [P1]-[P8] and they are only briefly referred in the text to ensure the link between them.

In this introductory chapter, we have defined the problems addressed by this thesis and demonstrated the need for efficient solutions to the channel estimation problem. Concern-

<sup>1</sup>We mean by LOS identification, the decision whether the first arriving path is LOS or NLOS component, and we mean by LOS estimation, the delay estimation of the LOS component.

ing the mobile positioning issue, we have presented the key elements and main problems encountered.

Chapter 2 develops the signal and channel models for the WCDMA communication system over fading channels. The focus is on downlink WCDMA where different signals are transmitted synchronously within a cell and different BSs transmit asynchronously. At each MS end, besides the Downlink Dedicated Physical Channel (DPCH) carrying the data, a continuous pilot channel called the Common Pilot Channel (CPICH) is available from each BS. It is used for link measurements and channel estimation. If the mobile is unable to receive clearly one dominant CPICH, due to interference or coverage problems, the result is likely to be dropped calls, failed initiations, poor voice quality and/or poor data throughput.

In Chapter 3, a short overview of mobile positioning principles is given. The main positioning technologies are described and the key issues and main problems encountered during the positioning procedure are discussed.

Chapter 4 is dedicated to three issues. First, it provides a general discussion about channel estimation algorithms, i.e., estimating the multipath delays and the complex channel coefficient for each detectable path. Here, we divided the presented algorithms into Bayesian approach or feedback based solutions and into feedforward algorithms. Second, it discusses the effect of the interference due to the neighboring CPICH and introduces different techniques to mitigate this interference in order to improve the estimation of the first arriving path. Third, this chapter introduces the implementation complexity studies of some of the presented algorithms when using a programmable DSPs, such as the Texas Instruments processor family TMS320C6x.

Chapter 5 is dedicated to the LOS detection issue. First it treats the link-level techniques that exploit the statistical properties of the channel to decide whether the first arriving path corresponds to LOS or NLOS situation. Then, it analyzes a set of measurement data collected in typical urban environment around the city center of Helsinki, Finland, with the goal of understanding the mobile channel behavior when the target issue is mobile positioning applications. Here basically, we look at the occurrence of LOS situations, the distribution of the first arriving path power, and the estimation of the MS speed. This framework is intended to analyze the capabilities of MS positioning in real world environments.

Chapter 6 gives an overview of the publication results and describes the author's contribution to each one of them. The results of this work are given in the publications included as appendices. Finally, conclusions and future work directions are drawn in Chapter 7.





# Chapter 2

## Radio Channel and Signal Models

*This chapter provides a short overview of the channel and signal models used in this thesis. The focus is on the downlink WCDMA communication system over fading channel. It gives the main parameters that characterize the time varying nature of the radio channel.*

### 2.1 RADIO CHANNEL MODEL

The most general definition of the channel is everything between the information source and the information absorber or sink. However, in a wireless communication system, usually the designer specifies most of the elements between the source and sink, with the exception of the free-space medium. Therefore, in this thesis we restrict our definition of radio channel to this free-space medium. A number of models have been proposed to model the free-space effects [3], [4], [52]. These models try to emulate the most severe distortion caused by the wireless channels, which is the multipath distortion. As seen in Figure 2.1, several paths can exist between the transmitter and the receiver of a wireless communication system. These paths are caused by different reflections, refractions, and scattering of the electro-magnetic waves carrying the information from the objects such as buildings, trees, ground, moving obstacles, etc. Signals from different paths add constructively or destructively, which results in rapid fluctuation of the signal amplitude within the order of a wavelength. Fading is often modeled as a complex Gaussian random process whose autocorrelation function (ACF) is determined by its Doppler spectrum in urban areas, where there is no line of sight between the transmitter and the receiver. Shadowing, on the other hand, occurs over a relative large area with different levels of clutter on the propagation path, which is also referred to as log-normal shadowing because the signal levels (measured in dB) follow a normal distribution with local mean depending on the separation distance between the transmitter and the receiver.

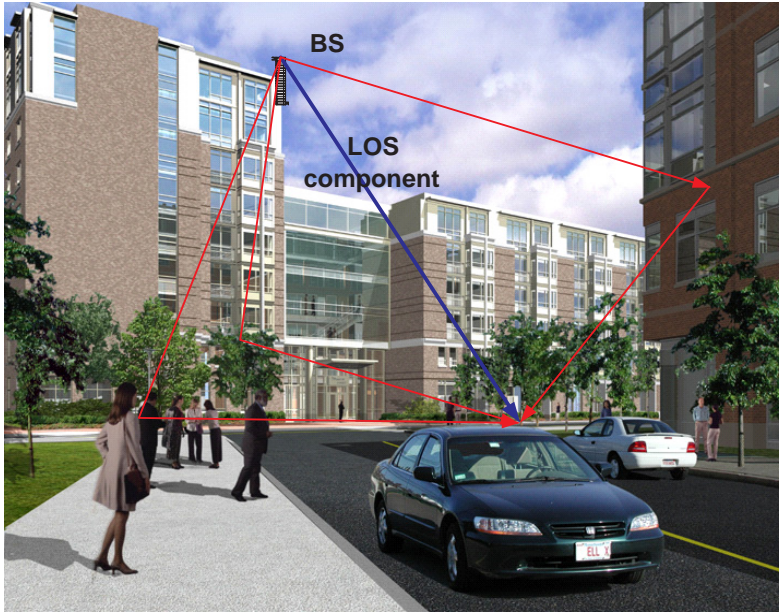

**Fig. 2.1** The wireless channel multipath phenomenon

This type of propagation channel can be modeled as a linear filter characterized by the following complex-valued lowpass equivalent impulse response:

$$h(t, \tau) = \sum_l a_l(t) e^{-j\theta_l(t)} \delta(\tau - \tau_l(t)), \quad (2.1)$$

where  $\delta(\cdot)$  is the Dirac delta function,  $l$  the multipath index, and  $\{a_l\}$ ,  $\{\theta_l\}$ , and  $\{\tau_l\}$  are the time-varying random channel amplitude, phase, and delay of the  $l^{\text{th}}$  path, respectively. Further,  $t$  is the time variable and  $\tau$  is the delay variable due to multipath propagation. We denote by  $\alpha_l(t) = a_l(t) e^{-j\theta_l(t)}$  the  $l^{\text{th}}$  complex channel coefficient at time  $t$ .

Typically, the physical radio channel changes on a longer time-scale than that of the transmitted signal. These changes occur due either to the movement of the mobile station (MS), or to the movements of its surroundings. If the mobile is fixed in a certain position in the space, and the surrounding objects are stationary, then, the physical radio channel does not change over time as seen from the mobile side. However, if the mobile moves a small fraction of a wavelength, then in the new position the physical channel is different. Since the move is only on a small fraction of a wavelength, the physical channel at the new position is quite similar to the one at the first position, and hence the physical radio channels at the two positions are highly correlated. Now, if we move over a distance of several wavelengths, then the correlation between the physical channels decay. Such small variations of the physical channel are denoted as *small-scale characteristics*. When the movement is of hundreds of wavelengths, then the variations in the physical channel are denoted as *large-scale characteristics*. In this thesis, we will restrict ourselves to the *small-scale characteristics* (fast fading), which is largely due to multipath propagation. The reason for such a choice is that these characteristics are most important within the scope of this thesis, effecting essentially on the signal processing methods to be studied.

By assuming that the statistics of the fading channel remain stationary over reasonably long time intervals, the fading AutoCorrelation Function (ACF) can be written as following [53]

$$\Phi_h(\tau, \tau + \delta\tau, \delta t) = \mathbf{E}(h^*(\tau, t)h(\tau + \delta\tau, t + \delta t)), \quad (2.2)$$

where  $\mathbf{E}(\cdot)$  is the Expectation operator, and  $(\cdot)^*$  denotes the complex conjugate. Furthermore, if we assume that the channel coefficients are uncorrelated, then the channel model becomes Wide-Sense Stationary Uncorrelated Scattering (WSSUC) model [1], [53], [54], and then the ACF becomes stationary in both time and delay directions and can be written as

$$\Phi_h(\tau, \tau + \delta\tau, \delta t) = \Phi_h(\delta\tau, \delta t). \quad (2.3)$$

For  $\delta t = 0$ , the autocorrelation function becomes  $\Phi_h(\delta\tau, 0) \equiv \Phi_h(\delta\tau)$ , and it is a measure of the intensity profile of the channel.

Considering the Fourier transform of the time delay ACF with respect to the time variable of the channel, we can define the Delay-Doppler-spreading function as:

$$\Psi_h(f, \tau) = \int_{-\infty}^{+\infty} \Phi_h(t, \tau) e^{-j2\pi ft} dt. \quad (2.4)$$

If we denote by  $H(\cdot, \cdot)$  the Fourier transform of the Channel Impulse Response (CIR)  $h(\cdot, \cdot)$  with respect to the time variation  $t$  as

$$H(\tau, f) = \int_{-\infty}^{+\infty} h(\tau, t) e^{-j2\pi ft} dt, \quad (2.5)$$

then the spaced-time spaced-frequency correlation function of the channel can be written as

$$\Phi_H(\delta f, \delta t) = \mathbf{E}(H^*(f, t)H(f + \delta f, t + \delta t)). \quad (2.6)$$

Here the Fourier transform of the spaced-time spaced-frequency correlation function with respect to  $\delta t$ , the time spacing, reflects the "frequency (Doppler shift) content":

$$\Upsilon_H(\delta f, \nu) = \int_{-\infty}^{+\infty} \Phi_H(\delta f, \delta t) e^{-j2\pi\nu\delta t} d(\delta t). \quad (2.7)$$

In particular, for  $\delta f = 0$ , we obtain the Doppler Power Spectrum (DPS) of the random channel:

$$\Upsilon_H(\nu) \equiv \Upsilon_H(0, \nu) = \int_{-\infty}^{+\infty} \Phi_H(\delta t) e^{-j2\pi\nu\delta t} d(\delta t), \quad (2.8)$$

where  $\Phi_H(\delta t) \equiv \Phi_H(0, \delta t)$ .

The bandwidth of  $\Upsilon_H(\nu)$  is known as the *Doppler spread* of the channel, denoted by  $\beta_d$ . The time domain dual of  $\beta_d$  is the *coherence time*  $(\delta\tau)_c$ , which is used to characterize the time varying nature of the channel. The relationship between  $\beta_d$  and  $(\delta\tau)_c$  is

$$(\delta\tau)_c \approx 1/\beta_d.$$

For example, if we define  $(\delta\tau)_c$  as the time over which the time correlation function is above the half of its maximum value [1], then  $(\delta\tau)_c$  is written as:

$$(\delta\tau)_c = \frac{9c}{16\pi\nu f_c}, \quad (2.9)$$

where  $c = 3 * 10^8$  m/s is the speed of light,  $v$  is the mobile speed, and  $f_c$  is the carrier frequency. We point out here that short coherence time (large  $\beta_d$ ) corresponds to fast fading, and similarly, long coherence time (small  $\beta_d$ ) corresponds to slow fading.

Two other parameters that characterize the time varying nature of the frequency dispersiveness of the channel are *the delay spread* and the *coherence bandwidth*. The *coherence bandwidth* is a statistical measure of the range of the frequencies over which the channel can be considered flat. The channel *delay spread* can be seen as the maximum delay range over which the channel time-delay ACF is non zero [1].

## 2.2 DS-CDMA SIGNAL MODEL

In a DS-CDMA system with  $N_{BS}$  base stations the received signal in digital domain, transmitted over an  $L_u$ -path fading channel with additive White Gaussian Noise (AWGN) can be written as [55]

$$r(i) = \sum_{m=-\infty}^{\infty} \sum_{u=1}^{N_{BS}} \sum_{l=1}^{L_u} \sqrt{E_{b_u}} \alpha_{l,u}^s(i) s_u^{(m)}(iT_s - \tau_{l,u}^s(i)) + \eta(i), \quad (2.10)$$

where  $i$  is the sample index,  $E_{b_u}$  is the bit energy of the  $u$ -th BS (we assume that all bits of the same BS have the same energy)<sup>1</sup>,  $T_s$  is the sampling period ( $T_s = T_c / N_s$ ,  $T_c$  is the chip period, and  $N_s$  is the number of samples per chip or the oversampling factor),  $\alpha_{l,u}^s(i)$  and  $\tau_{l,u}^s(i)$  represent, respectively, the instantaneous complex-valued time-varying channel coefficient and delay of the  $l$ -th path of base station  $u$ , at the  $i$ -th sample.  $s_u^{(m)}(\cdot)$  is the signature of user of the  $u^{th}$  base station during symbol  $m$  including data modulation, spreading code and pulse shaping, defined as (for clarity, we assume that all BSs have the same symbol period and the same chip period)

$$s_u^{(m)}(iT_s) = \sum_{k=0}^{S_F} c_{k,u}^{(m)} g(iT_s - kT_c - mT_{symp}), \quad (2.11)$$

where  $c_{k,u}^{(m)}$  is the  $k$ -th chip of BS  $u$  during the  $m$ -th symbol,  $g(\cdot)$  is the chip pulse shape filter after the matched filtering, that is  $g(t) = g_T(t) \otimes g_R(t)$  ( $g_T(\cdot)$  is the transmitter pulse shape and  $g_R(\cdot)$  is the receiver filter matched to the transmitter pulse shape<sup>2</sup>), and  $S_F$  is the spreading factor assumed to be the same for all BSs. In equation (2.10)  $\eta$  is additive white Gaussian noise of zero mean and double-sided spectral power density  $N_0$ .

The output of the matched filter corresponding to the desired BS  $u$  during the symbol  $n$  with lag  $\tau$  can be written as:

$$y_u(n, \tau) = \sum_{v=1}^{N_{BS}} \sum_{l=1}^{L_v} \sqrt{E_{b_v}} \alpha_{l,v}(n) \mathcal{R}_{u,v}(\tau - \tau_{l,v}(n)) + \tilde{\eta}(n). \quad (2.12)$$

<sup>1</sup>Here we describe basically the DS-CDMA downlink system model, that is why we use the terminology "Base station" instead of "user". However, it is straightforward to describe the uplink model based on the same notation by changing BS  $u$  with user  $u$

<sup>2</sup>In WCDMA both  $g_T$  and  $g_R$  are Root Raised Cosine filters [13]

Here,  $\mathcal{R}_{u,v}(\cdot)$  is the cross-correlation between the signature of the base station of interest ( $u$ -th base station) and the signature of the  $v$ -th base station,  $\tilde{\eta}(n)$  is the filtered noise plus interchip and intersymbol interference,  $\alpha_{l,v}(n)$  and  $\tau_{l,v}(n)$  are the complex channel coefficient, and the path delay, respectively, at symbol level. We point out that the channel coefficients and delays are assumed to be constant within one symbol. This assumption is reasonable since the symbol period (e.g.,  $66.5 \mu\text{s}$  for  $S_F = 256$ ) is much less than the coherence time of the channel<sup>3</sup>. The constant delays assumption is also reasonable for terrestrial communications. For example, if we consider a mobile receiver moving at the speed of  $22.2 \text{ m/s}$ , a delay variation of quarter of a chip requires around  $0.14$  seconds. This means that the delay variation due to Doppler shift can be neglected

As shown in the signal model, the mobile terminal can measure also the signals coming from the remote BSs, which are useful for mobile positioning. Therefore, various types of fading can be used to characterize the channel propagation, such as Rayleigh, Rician, Nakagami- $m$ , Weibull, log-normal, Suzuki and other mixed distributions [3], [56], [57]. The shadowing effect, generally modeled using log-normal distribution can characterize efficiently the propagation path from distant BSs. However, when little shadowing is present, the propagation path can be efficiently modeled using Rayleigh distribution [57].

<sup>3</sup>For example for a carrier frequency of  $2.15 \text{ GHz}$ , and a mobile speed of  $16.6 \text{ m/s}$  (i.e.,  $60 \text{ km/h}$ ),  $(\delta\tau)_c = 1.5 \text{ msec}$



# Chapter 3

## Mobile Positioning

*This chapter provides a short overview of the mobile positioning principles. It gives a description of both cellular and satellite-based positioning systems, with an emphasis on the main problems and challenges encountered. The focus is on the standardized technologies.*

### 3.1 MOTIVATION

For the public interest, mobile phone positioning in a cellular network with reliable and rather accurate position information has become unavoidable after the U.S. Federal Communications Commission mandate, FCC-Emergency 911 (E911) docket on emergency call positioning in USA, and after the coming E112 directive in the European Union [30]. For Phase II implementation, the FCC required that public safety answering point (PSAP) attendants of wireless communications networks must be able to know a 911 caller's phone number and its location so that calls can be routed to an appropriate emergency assistance attendants. In 1999 the FCC decided to tighten the Phase II location accuracy requirement from 125 m in 67 % percent of all cases to new numbers: for hand-set-based solutions, 50 m in 67 % of calls and 150 m in 95 % of calls; for network-based solutions, 100 m in 67 % of calls and 300 m in 95 % of calls. In 2000, the FCC required wireless communications operators to offer operational location-capable phones by October, 2001.

### 3.2 OVERVIEW OF EXISTING POSITION LOCATION SYSTEMS

A number of position location systems have evolved over the years. They can be classified to two categories, satellite-based or cellular-based positioning technology.



### 3.2.1 Satellite-Based Positioning Technology

Global Navigation satellite systems (GNSS) like GPS or the up-coming European system Galileo, expected to operate around the year 2008, are designed to offer world-wide positioning services for the public use. Today, GPS is the most popular radio navigation aid and has overtaken virtually all other forms of radio navigation because of its high accuracy, worldwide availability, and low cost. The principle behind GPS (respectively Galileo) is simple, although the implementation of this time-of-arrival (TOA) system is quite complex. Galileo, like GPS, uses precise timing within a group of satellites and transmits a spread spectrum signal to earth on different bands shown in Fig. 3.1 [58], [59]. In support of GNSS, the United States, as part of its GPS modernization initiative, has identified two new coded signals for civil use. One of these will be placed co-frequency with an existing government signal at 1227.6 MHz (designated as L2). This frequency falls in a band utilized extensively by high power air traffic control and military surveillance radar, however it should be available in most locations for ground-based use. The latter new signal was selected as being centered on 1176.45 MHz (designated as L5). All three civil signals (L1-C/A, L2-C/A, and L5) will be available for initial operational capability by 2010, and for full operational capability by approximately 2013. For Galileo, the signal is transmitted in three bands, E2-L1-E1 band, E6 band, and E5 band offering a variety of services. However, its standardization is still in progress.

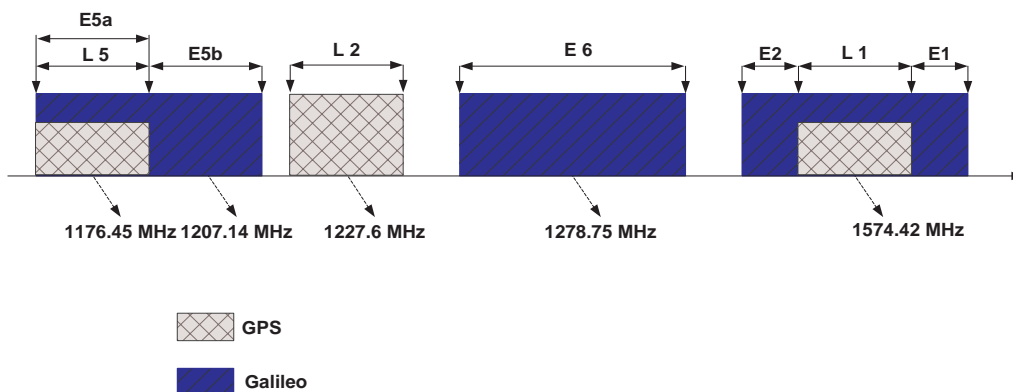

**Fig. 3.1** GPS and Galileo Frequency Baseline.

GPS and Galileo positioning is based on measuring relative TOA of signal sent simultaneously from different satellites. In theory three TOA measurements are required to calculate the mobile position and also its velocity, under the assumption of having direct link between the transmitter and the receiver (i.e., LOS component present). However, positioning needs to be carried out in all the environments covered by the wireless communication services, including the most constraining areas such as dense urban areas and obstructed indoor environments. The signal transmitted from the GNSS satellites experiences severe attenuation while penetrating all the construction materials making the visibility with the sky quite rare, besides that the indoor propagation of satellite signals are not well understood yet. For all these reasons, the positioning operation becomes quite challenging task. A short study and preliminary results of these issues are described and analyzed in Section 5.5.

In order to recover the positioning capability in these environments, the missing information can be acquired through a cellular network leading to the Assisted-GPS (AGPS) based solution shown in Fig. 3.2.

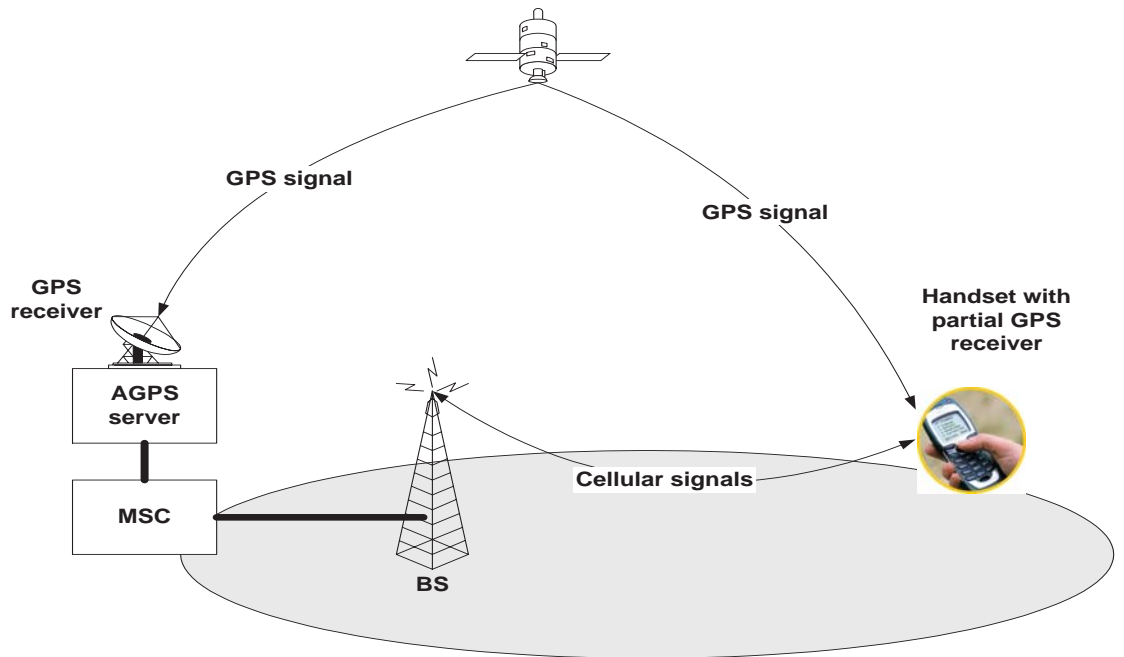

Fig. 3.2 Assisted-GPS concept.

Currently, the accuracy of GPS and AGPS is around the 10 meters, while Galileo is expected to provide an accuracy of less than 1 m for some services as shown in Table 3.1 [60].

Tab 3.1: Positioning accuracy with Galileo

	Open Services (OS)	Commercial Services (CS)		Public Regulated Services (PRS)		Safety-of-Life Service (SoL)
Coverage	Global	Global	Local	Global	Local	Global
Accuracy	DF: H: 4 m, V: 8 m MF: H: 15 m, V: 35 m	DF: < 1 m	< 10 cm Augmented signals	H: 6.5 m V: 12 m	1 m Augmented signals	DF: 4-6 m
Availability	99.8 %	99.8 %		99 - 99.9 %		99.8 %

### 3.2.2 Cellular Network-Based Positioning

The different positioning methods can be divided into 3 categories: network based solutions, terminal based solutions, or hybrid solutions depending on whether the position estimate computation takes place in the fixed BS network, or on the mobile unit or in both sides [8], [61]. The BS network can offer more computational power for the needed calculation. However, terminal based solutions would improve personal identity security and decrease the network load.

The four commonly used geolocation techniques are based on:

- Signal strength estimation.
- Time of Arrival (TOA).
- Time Difference of Arrival (TDOA).
- Angle of Arrival (AoA).

There are other techniques such as the identification of the serving BS (cell Id method). However, its accuracy is very poor especially in rural areas and can not meet in any case the FCC requirements [30]. The most prominent geolocation techniques that have been approved for standardization within the 3<sup>rd</sup> Generation Partnership Project (3GPP) are [8]:

1. *Time of Arrival (TOA)*: For the synchronized transmitter and receiver, the arrival time of the known signal indicates the propagation delay. The measurements of at least three links have to be done with respect to a synchronized and common reference clock. The geolocation is then determined by the intersection of three circles. This techniques requires full network synchronization, which is not the case of 3G networks. For an asynchronous networks, the Time difference of arrival (TDOA) is possible alternative to avoid the need of universal clock. By using 4 or more measurements estimates, the mobile geolocation is determined by the intersection of 3 hyperbola. Both TOA and TDOA use the uplink signal transmitted by the MS. Because of the limited resources available, the capacity of TOA and TDOA methods is limited and they can be used only for low rate services, e.g., emergency calls, as it is not economically feasible to build uplink Location based Services (LCS) suitable for commercial high rate applications
2. *Observed Time Difference of Arrival (OTDOA)* [61]: For asynchronous networks, the Observed Time difference of arrival is basically a reverse of network based TDOA. The OTDOA has been approved for standardization in different cellular systems. For GSM, it is called Enhanced-Observed time difference (E-OTD) [61]. In 3G networks it is OTDOA-IPDL [12], [61], [62] and in US-CDMA, it is called Advanced Forward Link Trilateration (A-FLT).

In Table 3.2 we show the current status of geolocation technologies in the standardization process. Note that A-GPS is being standardized for all air-interfaces: first-generation analog (AMPS), second-generation digital (GSM, CDMA, TDMA), as well as for 3GPP (3<sup>rd</sup> Generation Partnership Project for mobile systems based on evolved GSM core networks) and 3GPP2.

**Tab. 3.2:** Geolocation technologies in wireless standards

Wireless standard	Standard body	Geolocations technologies used	Publications date
<b>GSM</b>	ETSI	TOA, AOA, E-OTD, AGPS	Jan. 2000
<b>GSM (North america)</b>	T1P1.5 ETSI	TOA, AOA, E-OTD, AGPS	Jan. 2000
<b>cdma2000, cdmaOne</b>	TR-45.5, 3GPP2	AGPS, A-FLT	Nov. 1999, Dec. 2000, Feb. 2002
<b>3G</b>	3GPP	AGPS, OTDOA-IPDL	Apr. 2001, on-going

### 3.2.3 Problems and Challenges in Mobile Positioning

Position estimation using the cellular network is convenient since it takes advantage of the existing cellular network structure and it only requires the existing signal as input. However, it also inherits the disadvantages imposed by the design of the network. In most positioning techniques, two or more non-serving BSs are involved in the positioning procedure. The main problem and challenges can be listed as the following:

1. *Hearability problem:* In CDMA system, the powers of MS and BS are limited in order to reduce the interference to other cells. Therefore, it is difficult for the MS to transmit or receive signals to or from the other BSs than the BS of its serving cell, except when the MS is in the edge of the cell. One idea to overcome this problem, initially proposed in [12], is that each BS turns off its transmission for a well-defined period of time in order to let the terminals measure the other BSs within its coverage. This technique is known as Idle Period-Down Link transmission (IPDL) [13].
2. *Non-Line-of-Sight (NLOS) problem:* Most of the location systems require Line-of-Sight (LOS) link between the transceivers. NLOS errors could degrade the location estimate substantially, and this can be considered as a killer issue in location estimation.
3. *Closely-spaced path (CSP) problem:* In many cases, it may happen that the LOS signal is obstructed by the Non-LOS (NLOS) components, arriving within a short delay (at the sub-chip level) at the receiver. This situation of overlapping multipath propagation (called also as Closely-spaced path (CSP)) is one of the main sources of mobile-positioning errors [15], [16], [17].
4. *Accuracy problem:* There are two types of accuracy: measurement accuracy and location estimate accuracy. Obviously, the location estimate accuracy depends on the measurement accuracy. The degradation of the measurement accuracy derives from different factors, such as the Signal-to-Noise ratio (SNR), interference (inter-cell and intra-cell interference), multipath characteristics, etc. Constructing better receivers and developing better algorithms are the major concerns for accuracy improvement.

### 3.3 FADING DISTRIBUTIONS IN LOS/NLOS PROPAGATION

Few papers have addressed the LOS detection issue. Most of the previous studies used range measurement based techniques [49], [50], [51], where they exploit the time history of the range measurements and the *a priori* knowledge of the noise floor in the system to correct the position estimation during the NLOS situations. However, no explicit techniques are provided to separate LOS and NLOS situations. These techniques can increase the accuracy of the mobile position estimation, but they require *a priori* statistic parameters such as the standard deviation of the measurement noise [49], [50].

In the literature, the fading channel with LOS component has been widely modeled via Rician distribution, and the fading channel with only NLOS components has been modeled via Rayleigh distribution [1], [2], [3]. The Rician fading model is more general and incorporate also the LOS situations, both for terrestrial and satellite communications. The time varying envelopes  $a_l(t)$  are distributed according to the Rician distribution if the probability density function (PDF)  $p(a_l(t))$  satisfies:

$$p(a_l(t) = a) = \frac{2a(1+K)}{\Omega} \exp\left(-K - \frac{a^2(1+K)}{\Omega}\right) I_0\left(2a\sqrt{\frac{K(1+K)}{\Omega}}\right), \quad (3.1)$$

where  $\Omega$  is the average power of the  $l^{th}$  path,  $\Omega = E[a_l(t)^2]$ , and  $K$  is the Rician factor. For  $K = 0$ , the PDF becomes Rayleigh distribution.  $I_0$  is the zero-th order modified Bessel function of the first kind:

$$I_0(t) \triangleq \frac{1}{2\pi} \int_0^{2\pi} \exp(t \cos v) dv = \sum_{m=0}^{+\infty} \left(\frac{t}{2}\right)^{2m} \frac{1}{(m!)^2} \quad (3.2)$$

Examples of Rician PDFs are shown in Fig. 3.3.

Another interesting distribution that often gives the best fit to land-mobile [3], [63], [64] and indoor-mobile multipath propagation [6] and might be used to model LOS and NLOS cases is the Nakagami- $m$  distribution. This distribution also covers many other distributions, such as the one-side Gaussian distribution for  $m = 1/2$ , the Rayleigh distribution for  $m = 1$ , and at the limit when  $m \rightarrow +\infty$ , the Nakagami- $m$  fading channel converges to a non-fading AWGN channel.

The time varying envelope  $a_l(t)$  is distributed according to the Nakagami- $m$  distribution if the probability density function (PDF)  $p(a_l(t))$  satisfies [3], [7]:

$$p(a_l(t) = a) = \frac{2}{\Gamma(m)} \left(\frac{m}{\Omega}\right)^m a^{2m-1} \exp\left(-\frac{ma^2}{\Omega}\right), \quad (3.3)$$

where  $\Gamma(\cdot)$  is the Gamma function and  $m$  the Nakagami parameter defined respectively as [3], [7]:

$$\Gamma(m) \triangleq \alpha^m \int_0^{+\infty} t^{m-1} \exp(-\alpha t) dt, \quad (3.4)$$

$$m = \frac{(\mathbb{E}(a^2))^2}{\text{Var}(a^2)}, \quad (3.5)$$

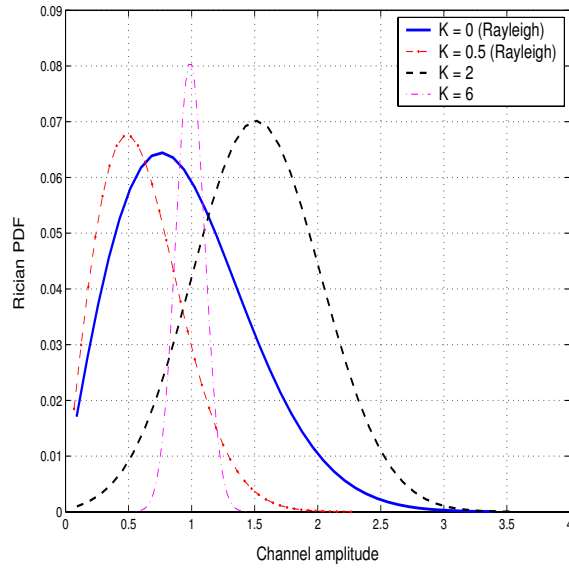

**Fig. 3.3** Examples of Rician PDFs for different Rician parameters. Rayleigh distribution for  $K \sim 0$

(i.e.,  $m$  is equal to the inverse of the normalized variance of  $a^2$ ).

Examples of Nakagami- $m$  PDFs for different  $m$ -parameters are shown in Fig. 3.4.

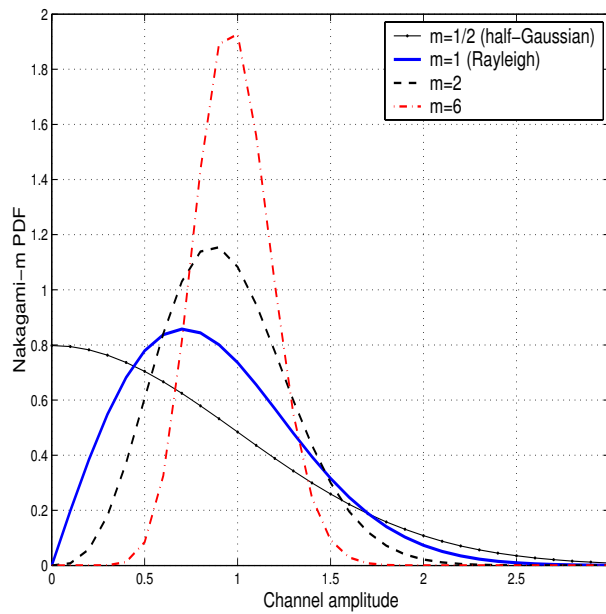

**Fig. 3.4** Examples of Nakagami- $m$  PDFs for different  $m$  parameters. Rayleigh distribution for  $m \sim 1$ .



# Chapter 4

## Channel Estimation Algorithms

*This chapter provides a description of the joint estimation problem of the multipath delay and complex channel coefficients. First, the Bayesian approach based joint estimation is described. The main features and challenges of this approach are discussed. As practical implementations for the Bayesian approach, the Kalman Filters and Particle Filters are considered and their performance and complexity issues are analyzed in [P1], [P2], [P3], [P4]. Next, an overview of feed-forward channel estimators is given. The main existing algorithms and the new techniques introduced by the author are discussed in [P5], [P6], [P7]. We show also the impact of pulse shaping on the accuracy of multipath delay estimation. Based on these proposed algorithms, a parallel interference cancellation scheme is also proposed.*

### 4.1 INTRODUCTION

In general, the goal of the channel estimation may be expressed as the follows. Given the measurement signal  $y^{(n)} = \{y_1; y_2; \dots; y_n\}$ , the process model described below, and the initial guess  $p(x_0)$ , we have to determine the current state,  $x_k$ .

The process model may be expressed as follows:

$$\begin{cases} x_n = f_{n-1}\{x_{n-1}, w_{n-1}\} \\ y_n = h_n\{x_n, \nu_n\} \end{cases} \quad (4.1)$$

where  $x_n \in \mathbf{C}^{n_x}$  is the state vector, and  $f_n : \mathbf{C}^{n_x} \times \mathbf{C}^{n_w} \rightarrow \mathbf{C}^{n_x}$  is the system equation. The measurements,  $y_n \in \mathbf{C}^{n_y}$  are related to the state vector through the measurement equation  $h_n : \mathbf{C}^{n_x} \times \mathbf{C}^{n_\nu} \rightarrow \mathbf{C}^{n_y}$ . The system noise  $w_n \in \mathbf{C}^{n_w}$  represents the disturbances in the system, and the measurement noise,  $\nu_n \in \mathbf{C}^{n_\nu}$  captures the inaccuracy in measuring the system.



## 4.2 BAYESIAN APPROACH FOR CHANNEL ESTIMATION

Bayesian estimation provides a rigorous approach for estimating the probability distribution of unknown variables by utilizing all the available knowledge, data and information about the system. It considers all the variables to be stochastic and determines the distribution of the variables to be estimated,  $x$ , given the measurements,  $y$ . Using the generic symbol  $p$  to denote any probability density function, the conditional density function  $x$  given  $y$  is obtained via Bayes rule as,

$$p(x|y) = \frac{p(y|x)p(x)}{p(y)}, \quad (4.2)$$

The information contained in the current measurement is represented by the *likelihood*,  $p(y|x)$ , while the prior knowledge about the unknown variables is represented by  $p(x)$ . The denominator,  $p(y)$ , is the evidence provided by the measurements, and is a normalizing constant. Therefore, Eq. (4.2) combines *prior* and current knowledge to obtain the *a posteriori* information of the system. Bayesian estimation can handle all kinds of distributions in prior, likelihood and posterior.

For dynamic systems, a recursive formulation of Bayesian estimation may be represented as follows:

$$p(x_n|y^{(n)}) = \frac{p(y_n|x_n)p(x_n|y^{(n-1)})}{p(y_n|y^{(n-1)})}, \quad (4.3)$$

where the previous knowledge of the system,  $p(x_n|y^{(n-1)})$  is combined with the most current information of the system,  $p(y_n|x_n)$ , to find the posterior knowledge  $p(x_n|y^{(n)})$ . In Figure 4.1, we show the block diagram of recursive Bayesian estimation algorithms.

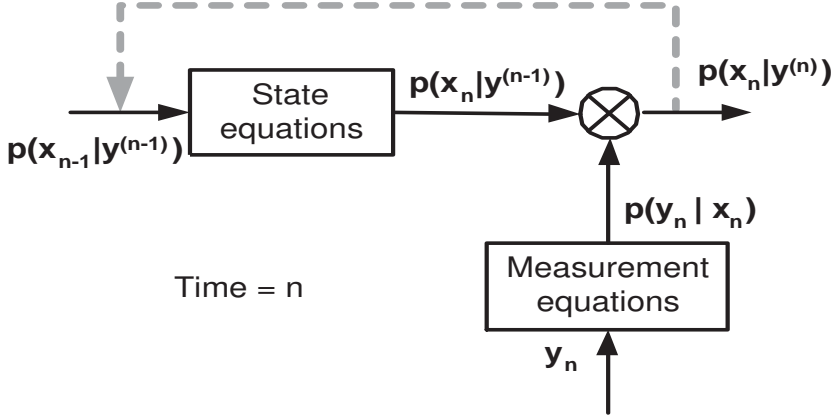

**Fig. 4.1** Block diagram of recursive Bayesian estimation algorithms.

By using the following relationship [65], [36], [66]

$$p(a) = \int p(a|b)p(b)db \quad (4.4)$$

we can write the prior PDF as:

$$p(x_n|y^{(n-1)}) = \int p(x_n|x_{n-1}, y^{(n-1)})p(x_{n-1}|y^{(n-1)})dx_{n-1}, \quad (4.5)$$

where  $p(x_{n-1}|y^{(n-1)})$  is the posteriori distribution at time  $n - 1$ . Since the system model described by Eq. (4.1) is a Markov process then  $p(x_n|x_{n-1}, y^{(n-1)}) = p(x_n|x_{n-1})$  and the prior distribution in Eq. (4.5) can be re-written as:

$$p(x_n|y^{(n-1)}) = \int p(x_n|x_{n-1})p(x_{n-1}|y^{(n-1)})dx_{n-1}. \quad (4.6)$$

Further simplification of  $p(x_n|x_{n-1})$  can be written as [65], [36], [66]:

$$p(x_n|x_{n-1}) = \int p(x_n|x_{n-1}, w_{n-1})p(w_{n-1}|x_{n-1})dw_{n-1}. \quad (4.7)$$

By using Eq. (4.1) and the fact that  $x_n$  is fully determined if both  $x_{n-1}$  and  $w_{n-1}$  are known, then we can write:

$$p(x_n|x_{n-1}) = \int \delta(x_n - f(x_{n-1}, w_{n-1}))p(w_{n-1})dw_{n-1}, \quad (4.8)$$

where  $\delta(\cdot)$  is the Dirac delta function. Furthermore,  $p(w_{n-1}|x_{n-1})$  is reduced to  $p(w_{n-1})$  with the assumption that the noise is independent of the current state.

Likewise  $p(y_n|x_n)$  can be written as:

$$p(y_n|x_n) = \int \delta(y_n - h(x_n, \nu_n))p(\nu_n)d\nu_n. \quad (4.9)$$

In general, there is no closed-form solution for Eq. (4.8) to (4.9), and direct integration is computationally expensive and may not be practical for high-dimensional systems. Most estimation methods address these computational challenges by making simplifying assumptions about the nature of the model and/or posterior distributions at the cost of accuracy, such is the case of Extended Kalman filter, which linearizes the observation model locally to be able to apply the Kalman filter, which is the optimal, unconstrained, and linear state estimator [66]. However, recent theoretical advances coupled with high computation power are providing the foundations for building a feasible Bayesian approach even for large scale systems. These computationally efficient algorithms are based on sequential Monte Carlo (SMC) sampling and will be discussed in Section 4.2.3.

We assume that both multipath delays and complex channel coefficients are unknown. Therefore, we mean by channel estimation the joint estimation of the multipath delays and complex channel coefficients.

### 4.2.1 Joint Channel Estimation

The Gauss Markov model of Eq. (4.1) can be adapted for the channel coefficients and delays as follows [31], [67], [68]

$$\begin{cases} \alpha_{l,v}(n+1) = \beta_v \alpha_{l,v}(n) + w_{\alpha_{l,v}}(n) \\ \tau_{l,v}(n+1) = \gamma \tau_{l,v}(n) + w_{\tau_{l,v}}(n), \end{cases} \quad (4.10)$$

where  $w_\alpha$  and  $w_\tau$  are mutually independent additive circular white Gaussian noise processes,  $\gamma$  is a coefficient accounting for the delay variation, and  $\beta_v$  are coefficients accounting for the maximum Doppler spread,  $f_D$  of the  $v$ -th BS, defined as [69]

$$\beta_v = I_0(2\pi f_D T_{sym}),$$

where  $I_0(\cdot)$  is the zero-order Bessel function and  $T_{sym}$  is the symbol interval. We assume that for each BS, all the paths have the same maximum Doppler spread.  $\beta_v$  are close to unity when the Doppler spread is significantly less than the Nyquist bandwidth. We assume here that the coefficient  $\gamma$  is constant for all the BSs and all the paths. This is a reasonable assumption in terrestrial communication, when the Doppler shift is negligible, and  $\gamma$  can be set to a value close to unity for all multipath delays of all users. The discrete state vector,  $\mathbf{x}(n) \in \mathbf{C}^{2LN_{BS} \times 1}$ , associated with all BSs is defined by:

$$\mathbf{x}(n) = \begin{bmatrix} \mathbf{x}_1, \dots, \mathbf{x}_{N_{BS}} \end{bmatrix}^T, \quad (4.11)$$

where  $\mathbf{x}_v = [\alpha_{1,v}(n), \dots, \alpha_{L,v}(n), \tau_{1,v}(n), \dots, \tau_{L,v}(n)]^T$ , for  $v = 1, \dots, N_{BS}$ .

The state and observation model of Eq. (4.1) can be re-written as:

$$\begin{cases} \text{State model:} & \mathbf{x}(n+1) = \mathbf{F}\mathbf{x}(n) + \mathbf{w}(n) \\ \text{Measurement model:} & \mathbf{y}(n) = \mathcal{H}(\mathbf{x}(n)) + \nu(n), \end{cases} \quad (4.12)$$

where,  $\mathbf{w}(\cdot)$  and  $\nu(\cdot)$  are circular white Gaussian noise processes.  $\mathbf{F} \in \mathbf{R}^{2LN_{BS} \times 2LN_{BS}}$  defined by  $\mathbf{F} = \text{Block diag}(F_1, \dots, F_{N_{BS}})$ , where  $F_v = \text{diag}(\beta_1, \dots, \beta_{N_{BS}}, \gamma, \dots, \gamma)$ .  $\mathbf{y}(n)$  is the observation vector, which depends nonlinearly on the state vector  $\mathbf{x}(n)$ ,

$$\mathbf{y}(n) = [y_1(n), \dots, y_{N_{BS}}(n)]^T.$$

## 4.2.2 Extended-Kalman-Filter Based Estimation

From the state and measurement models depicted in Eq. (4.12), and from the output of matched filter shown in Eq. (2.12) we can see that the observation variables depend linearly on the complex channel coefficients and nonlinearly on the multipath delays. The EKF is one approximation for calculating the Eq. (4.3). The EKF linearizes the nonlinear system, then it applies the Kalman filter to obtain the state estimates. The most common linearization method used is the first order Taylor expansion defined as follows [31], [70], [71]:

$$\mathcal{H}(\mathbf{x}(n)) \approx \mathcal{H}(\hat{\mathbf{x}}(n | n-1)) + \sum_{m=1}^{2LN_{BS}} \left( \mathbf{x}_m(n) - \hat{\mathbf{x}}_m(n | n-1) \right) \times \left. \frac{\partial}{\partial \mathbf{x}_m} \mathcal{H}(\mathbf{x}(n)) \right|_{\mathbf{x}(n) = \hat{\mathbf{x}}(n | n-1)}, \quad (4.13)$$

where,  $\hat{\mathbf{x}}(n | n-1)$  is the predictor at step  $n$  conditional to previous observations,  $\mathbf{x}_m(n)$  are the elements of the state vector  $\mathbf{x}(n)$ , and  $\hat{\mathbf{x}}_m(n | n-1)$  are the elements of the predictor vector  $\hat{\mathbf{x}}(n | n-1)$ ,  $m = 1, \dots, 2LN_{BS}$ . Therefore,  $\mathcal{H}(\mathbf{x}(n))$  can be expressed as:

$$\mathcal{H}(\mathbf{x}(n)) = \begin{bmatrix} H_1(\mathbf{x}(n)), \dots, H_{N_{BS}}(\mathbf{x}(n)) \end{bmatrix}^T, \quad (4.14)$$

where  $H_i(\mathbf{x}(n)) = \sum_{v=1}^{N_{BS}} \sum_{l=1}^L \sqrt{E_{b_v}} \alpha_{l,v}(n) \mathcal{R}_{i,v}(nT_{sym} - \tau_{l,v}(n))$ , for  $i = 1, \dots, N_{BS}$ .

Some authors have studied the problem of joint parameters estimation using Kalman filtering in multipath fading and multiuser environment. In [31], Iltis et al. have developed a new technique for estimating jointly the channel coefficients and the first path delay in frequency selective channel with uniformly spaced path delays based on Kalman filtering in a single user system. Later on, the idea has been extended to multiuser scenario to estimate jointly the channel parameters and Doppler shift [67].

In our work, EKF showed good performance in tracking both distant and closely-spaced paths with non-uniformly spaced path delays with good accuracy [P1], [P2], [P7].

### 4.2.3 Particle Filter Based Estimation

As an alternative to the solutions that linearize locally the observation, Julier and Uhlmann introduced a new filter in 1997 [72], called the Unscented Kalman filter (UKF). This filter uses a deterministic sample-based approximation to estimate the effect of the nonlinearity. There are two main advantages of UKF method over the EKF. First, the UKF does not use any Jacobian computation as in the case with EKF, which needs to compute the first order Taylor approximation, and second, the UKF operates on the premise that it is easier to approximate a Gaussian distribution than it is to approximate an arbitrary nonlinear function [65]. However, the UKF has the limitation that it does not apply to general non-Gaussian distributions. Recently, researchers started to pay more attention to a new family of filters based on the sequential Monte Carlo (SMC) methods, also known as Particle filter (PF). These methods were first introduced by Salmond, et al. [35] in 1993, and further variations and enhancements have followed [33], [36], [37], [38].

Particle Filters (PF) are sequential Monte Carlo based methods, which use a set of discrete samples (particles) to approximate the probability density function (PDF) of the state variables. They have the ability to handle Gaussian as well as non-Gaussian systems. In the joint estimation of complex channel coefficients (linear variable) and multipath delays (nonlinear variable), it is optimum to sample only from the nonlinear variable [33], and use the Kalman filter in order to estimate the complex channel coefficients. Therefore, the state and observation models given in Eq. (4.12) are now formulated as:

$$\begin{cases} \mathbf{x}_c(n+1) = \mathbf{F}_c \mathbf{x}_c(n) + \mathbf{w}_c(n) \\ \mathbf{x}_d(n+1) = \mathbf{F}_d \mathbf{x}_c(n) + \mathbf{w}_d(n) \\ \mathbf{y}(n) = \mathcal{H}(\mathbf{x}_d(n)) \mathbf{x}_c(n) + \nu(n), \end{cases} \quad (4.15)$$

where,  $\mathbf{x}_c(n)$  and  $\mathbf{x}_d(n) \in \mathbf{C}^{LN_{BS} \times 1}$  are the two state vectors and for  $u = 1, \dots, N_{BS}$ ,  $\mathbf{x}_{cu}$ , and  $\mathbf{x}_{du}$  are defined as

$$\begin{cases} \mathbf{x}_{cu} = [\alpha_{1,u}(n), \dots, \alpha_{L,u}(n)]^T \\ \mathbf{x}_{du} = [\tau_{1,u}(n), \dots, \tau_{L,u}(n)]^T. \end{cases} \quad (4.16)$$

Above  $\mathbf{w}_c(\cdot)$ ,  $\mathbf{w}_d(\cdot)$ , and  $\nu(\cdot)$  are circular white Gaussian noise processes with covariance matrices  $\mathbf{Q}_{w_c}$ ,  $\mathbf{Q}_{w_d}$  and  $\mathbf{R}$ , respectively. The matrices  $\mathbf{F}_c$  and  $\mathbf{F}_d$  can be expressed easily based on the expression of  $\mathbf{F}$  given in Section 4.2.1.

The unconditional state estimate can be computed using the Importance Sampling method defined by [37]:

$$\hat{\mathbf{x}}_d(n|n) = \sum_{i=1}^{N_P} \hat{\mathbf{x}}_{di}(n|n) w_i^{(pf)}(n), \quad (4.17)$$

where  $N_P$  is the number of particles used to approximate the PDF of the state, and  $w_i^{(pf)}(n)$  is the  $i$ -th weight coefficient defined by:

$$w_i^{(pf)}(n) = \frac{p(\mathbf{x}_{di}^{(n)}|\mathbf{y}^{(n)})}{\pi(\mathbf{x}_{di}^{(n)}|\mathbf{y}^{(n)})}. \quad (4.18)$$

Here  $p(\cdot)$  and  $\pi(\cdot)$  are the true and simulation probability density, respectively and  $\mathbf{x}_{di}^{(n)}$  is the  $i^{th}$  cumulative sampled sequence of the state vector  $\mathbf{x}_d(n)$ . The simulation density is chosen to be in recursive form, so that we can propagate the estimates in time without modifying subsequently the past simulated trajectories [37]:

$$\pi(\mathbf{x}_{di}^{(n)}|\mathbf{y}^{(n)}) = \pi(\mathbf{x}_{di}(n)|\mathbf{y}^{(n)}, \mathbf{x}_{di}^{(n-1)})\pi(\mathbf{x}_{di}^{(n-1)}|\mathbf{y}^{(n-1)}). \quad (4.19)$$

This algorithm may also be expressed in a recursive form which has prediction and update stages at each time step. In the prediction stage, samples representing the current state are generated from the importance function  $\pi(\mathbf{x}_{di}^{(n)}|\mathbf{y}^{(n)})$ . Finding this importance function involves the multiplication of  $\pi(\mathbf{x}_{di}(n)|\mathbf{y}^{(n)}, \mathbf{x}_{di}^{(n-1)})$  and  $\pi(\mathbf{x}_{di}^{(n-1)}|\mathbf{y}^{(n-1)})$ , which may be interpreted as the prediction of current state based on the prior distribution  $\pi(\mathbf{x}_{di}^{(n-1)}|\mathbf{y}^{(n-1)})$ . In the update stage, the prediction is updated by the information contained in the current measurement, i.e., the likelihood.

In our work, particle filters showed good performances in tracking both multipath delays and complex channel coefficients. They showed high robustness to the initialization conditions [P3],[P4]. However, compared to EKF filters, their implementation complexity is much higher [P4].

### 4.3 FEEDFORWARD APPROACH

Resolving multipath components based on feedforward approaches is widely used in the literature [28], [17], [26], [21], [24], [73], [74]. The delay estimation can be performed either in the wide-band domain for example via eigenvalue decomposition of the received signal covariance matrix, or in the narrow-band domain at the output of the matched filter. After eigenvalue decomposition or the despreading, the delay estimation is done based on further optional signal processing such as deconvolution or non-linear processing. The best known ones are the Least Squares (LS) techniques [21], [22], [23], the Projection Onto Convex Sets (POCS) algorithm [24], [25], [28], [P5] and Teager Kaiser based filtering [27], [28], [P6].

The performance of all these techniques is significantly affected by the presence of the Root Raised Cosine (RRC) pulses and further methods should be derived to improve the delay estimates.

### 4.3.1 Deconvolution-Based Multipath Delay Estimation

Briefly, Eq. (2.12) can be re-written into vectorial form:

$$\mathbf{y}(n) = \mathbf{G}\mathbf{h}(n) + \mathbf{v}_\eta(n), \quad (4.20)$$

where  $\mathbf{y}(n)$  is the vector of correlation outputs, at different time lags between 0 and maximum channel delay spread  $\tau_{max}$ ,  $\mathbf{y}(n) \in \mathbf{C}^{N_{BS}(\tau_{max}+1) \times 1}$ . It is defined as

$$\mathbf{y}(n) = \begin{bmatrix} \mathbf{y}_1(n) \\ \vdots \\ \mathbf{y}_{N_{BS}}(n) \end{bmatrix},$$

and for  $i = 1, \dots, N_{BS}$ , the vector  $\mathbf{y}_i(n)$  is defined as

$$\mathbf{y}_i(n) = [y_i(n, 0), \dots, y_i(n, \tau_{max})]^T.$$

The matrix  $\mathbf{G}$  is the pulse shape deconvolution matrix written as:

$$\mathbf{G} = \begin{pmatrix} \mathbf{S}_{1,1} & \mathbf{S}_{1,2} & \cdots & \mathbf{S}_{1,N_{BS}} \\ \mathbf{S}_{2,1} & \mathbf{S}_{2,2} & \cdots & \mathbf{S}_{2,N_{BS}} \\ \cdots & \cdots & \cdots & \cdots \\ \mathbf{S}_{N_{BS},1} & \mathbf{S}_{N_{BS},2} & \cdots & \mathbf{S}_{N_{BS},N_{BS}} \end{pmatrix},$$

where the matrix  $\mathbf{S}_{u,v}$  is the pulse shape deconvolution matrix of the BSs pair  $(u, v)$ , with elements  $s_{i,j} = \sqrt{E_{b_v}} \mathcal{R}_{u,v}(i-j)$ , for  $i, j = 0, \dots, \tau_{max}$ .

Above,  $\mathbf{v}_\eta(n)$  is the sum of Inter-Symbol-Interference (ISI), Multiple-Access-Interference (MAI), and AWGN noises after the despreading operation. The vector  $\mathbf{h}(n)$  describes the channel profile from all the BSs, defined as  $\mathbf{h}(n) = [\mathbf{h}_1(n), \dots, \mathbf{h}_{N_{BS}}(n)]^T$ , where  $\mathbf{h}_u(n)$  of elements  $h_{l,u}$  is defined such that  $h_{l,u} = 0$  if no multipath is present at the time delay  $l$ , and  $h_{l,u} = \alpha_{l,u}$  if the index  $l$  corresponds to a true path location.

Therefore, resolving multipath components refers to the problem of estimating the non-zero elements of the unknown gain vector  $\mathbf{h}(n)$ . Equation (4.20) can be seen as a standard deconvolution problem with unknown parameter  $\mathbf{h}(n)$ . The Least Squares (LS) techniques [21], [22], [23], [28], [75], [P7] was shown to fail completely at low signal-to-noise ratios [28], [75]. Iterative solutions showed more robustness to noise and pulse shaping. An example of such iterative techniques is the Projection Onto Convex Sets (POCS) algorithm, originally proposed in [24], [25] for delay estimation in the Rake receivers, under the assumption of rectangular pulse shapes. An improvement of POCS was proposed and explained in [28] and introduced an additional constraint during the iterative process. POCS algorithms showed good performance in estimating both delays and channel complex coefficients in the presence of pulse shaping. New interference cancellation techniques based on the POCS algorithm have been developed in [P5].

### 4.3.2 Subspace Based Multipath Delay Estimation

The subspace based techniques provide a method for decomposing a multidimensional parameter search into a series of one dimensional optimization problems [18], [19], [20], [28],

[44]. Such an algorithm exploits the signal subspace spanned by certain observation vectors, in order to estimate the unknown channel parameters. Subspace-based algorithms for channel estimation have been shown to be near-far resistant and effective in the presence of multiple propagation paths. The performance of the subspace-based channel estimation algorithms depend, to a large extent, on the speed and accuracy of the subspace estimation process, especially when the parameter (and hence the signal subspace) is time varying. The tool typically used to estimate the signal and noise subspaces of the received signal vectors is the Singular Value Decomposition (SVD) of an observation matrix formed from received data vectors [76], [77]. However, the SVD has high computational complexity, involving orthogonal rotations that require costly operations such as divisions and square-roots. The subspace estimation is a crucial step in this algorithm and it is necessary to update the estimate in response to any time variations in the channel.

One of the most known subspace based methods is the Multiple Signal Classification (MUSIC) algorithm [44], [18], [19], [20]. In [P6], the performance of MUSIC algorithm is shown in multiple cell-downlink WCDMA system and compared to the performance of other presented delay estimation algorithms.

### 4.3.3 Teager-Kaiser Based Multipath Delay Estimation

The nonlinear quadratic Teager Kaiser (TK) operator was first introduced for measuring the real physical energy of a system [78]. It was found that this operator is simple, efficient, and able to track instantaneously-varying spatial modulation patterns [79]. Since its introduction, several other applications have been found for TK operator, one of the most recent being the estimation of closely-spaced paths in DS-CDMA systems introduced by Hamila & al., for GPS and WCDMA systems [42], [80], [27]. It was found that the TK operator has good performance in separating closely spaced paths when rectangular pulse shaping is used. However, the performance degrades when using bandlimiting pulse shape (e.g., RRC) as it is the case in WCDMA system.

The continuous-time TK energy operator of a complex signal  $\phi_c(t)$  is defined by [27]:

$$\Psi_c(\phi_c(t)) = \dot{\phi}_c(t)\dot{\phi}_c(t)^* - \frac{1}{2}[\ddot{\phi}_c(t)\phi_c(t)^* + \phi_c(t)\ddot{\phi}_c(t)^*], \quad (4.21)$$

and similarly the discrete-time TK operator applied to a discrete complex signal  $\phi_d(n)$  is readily defined by [27], [81]

$$\Psi_d(\phi_d(n)) = \phi_d(n-1)\phi_d(n-1)^* - \frac{1}{2}[\phi_d(n-2)\phi_d(n)^* + \phi_d(n)\phi_d(n-2)^*]. \quad (4.22)$$

In [42], Hamila & al demonstrated the good performance and low computational complexity of TK approach, especially for ideal rectangular pulse shapes, when compared to well-known techniques (e.g., MUSIC) for estimating closely-spaced multipath delays in CDMA systems. However, the probability of acquisition of all compared techniques deteriorates dramatically when the RC pulse shape filter is used. Figure 4.2 shows the Teager-Kaiser energy for two closely-spaced paths when rectangular and RRC pulse shaping were used. It is clear that, in the case of the rectangular pulse shaping, the separation between the two paths is straightforward. However, when RRC shaping is used, the separation becomes more difficult. Despite of its decreased performance in the presence of RRC pulse shaping,

TK has still been shown to be a promising technique in CDMA applications, due to its low complexity. It was kept as a good candidate for comparisons in [P5], [P6], and [P7].

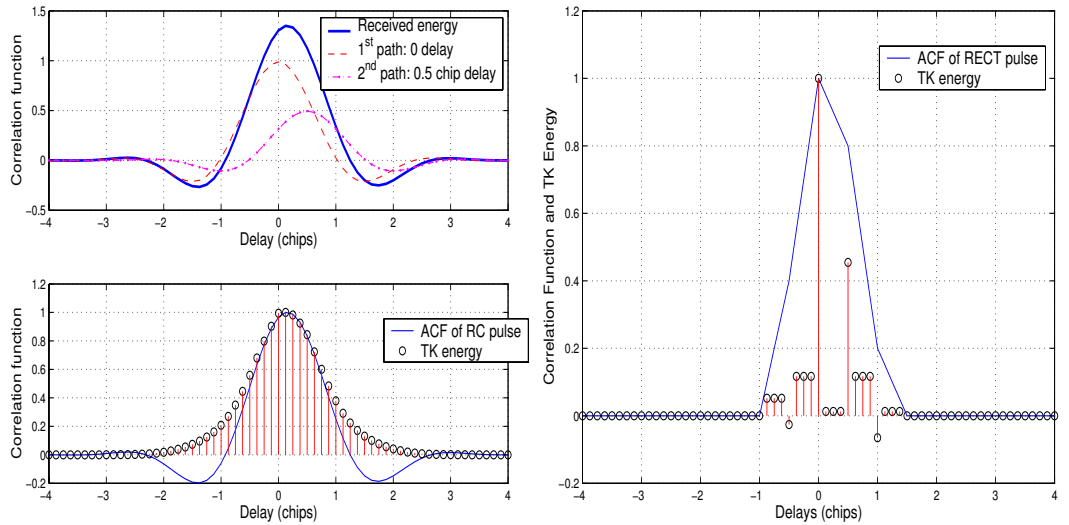

**Fig. 4.2** Teager-Kaiser energy for two closely-spaced paths when rectangular and RRC pulse shaping was used. Noise free case.

In [P6], we generalize the TK based multipath delay estimation technique to be used with bandlimited pulse shaping. The idea is to introduce a new deconvolution type filter function by which we filter the correlation function obtained via RC pulse shaping to recover an approximation of the correlation function ideally obtained via rectangular pulse shaping. This so-called Generalized Teager-Kaiser (GTK) deconvolution-based technique showed good performance in the presence of bandlimiting pulse shaping.

#### 4.4 INTER-CELL INTERFERENCE CANCELLATION

Delay estimation in CDMA receivers with Interference Cancellation (IC) or Minimization (IM) schemes has been widely proposed in the context of DLL based delay estimation [48], [45], [46], [47]. In all the proposed schemes, in order to perform the interference cancellation or minimization, we need to know the estimates of the delays and complex channel coefficients of the interfering paths. In [46] it was assumed that the channel complex coefficients and relative delays are *a priori* known, while in [48], the channel coefficients were computed via a maximum likelihood algorithm, and the initial delay estimates were assumed to be equal to the true path delays. The basic DLL based estimation with interference cancellation scheme combined with channel coefficient estimation in the context of bandlimiting pulse shaping can give good performance in multipath environments when the path spacing is greater than 1 chip, but they fail to estimate correctly the delays when the paths are closely spaced [28].

In [P2], [P5], [P7] we describe a cancellation scheme of the interference coming from other BSs (interference due to CPICH channels), where joint estimation of multipath delays and complex channel coefficients were performed. The interference coming from the other



users (i.e., DPCH channels [13]) is considered as additive white noise by virtue of central limit theorem, and it will be neglected by the interference cancellation algorithm.

Assuming that the desired BS has the index 1, based on Eq. (2.12) an estimation of the interfering signal will be straightforward:

$$\hat{y}_{int}(n, \tau) = \sum_{v=2}^{N_{BS}} \sum_{l=1}^L \sqrt{E_{b_v}} \hat{\alpha}_{l,v}(n) \mathcal{R}_{1,v}(\tau - \hat{\tau}_{l,v}(n)),$$

where  $\hat{\alpha}_{l,v}(n)$  and  $\hat{\tau}_{l,v}(n)$  are the  $l^{th}$  path estimates of the channel coefficient and delays of the  $v^{th}$  BS.

One measure of the interfering signal level can be defined through the near-far-ratio (NFR), which is defined as in [18], [19],  $NFR = 10 \log_{10}(P_k/P_1)$ , where  $P_k$  is the power of the interfering BSs, and  $P_1$  is the power of the desired BS. In the results shown in [P1]-[P7], the NFR spans the range from  $-20$  dB (very low interference level) to  $20$  dB (strong interference). The later case is reasonable from the mobile positioning point of view, since the mobile measure simultaneously different links.

The desired signal can be recovered as:

$$\hat{y}_{des}(n, \tau) = y_1(n, \tau) - \hat{y}_{int}(n, \tau). \tag{4.23}$$

Figure 4.3 shows the block diagram of a delay estimation algorithm with IC scheme. The interference estimation is carried out using any generic signal processing algorithm, such as EKF, PF, or POCS. The second stage of delay estimation, which is using only the desired signal, can be carried out using the same signal processing algorithm as in the first stage, or the delay estimation can be applied directly to the output of the matched filter.

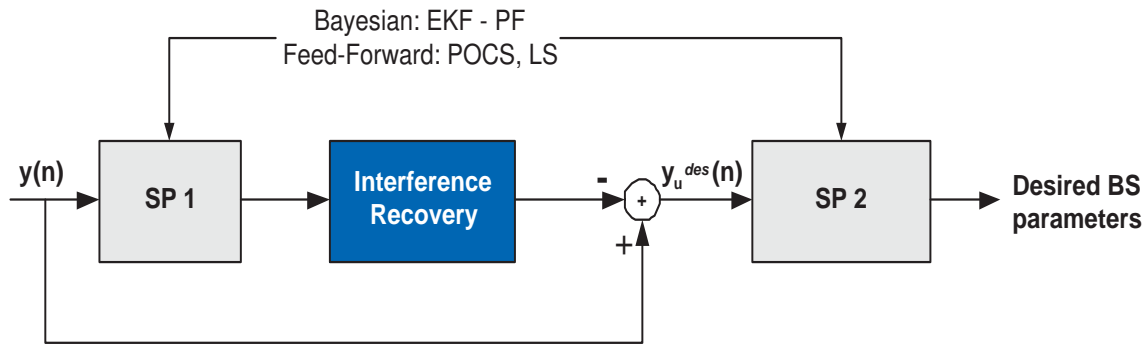

**Fig. 4.3** Block diagram of intercell interference cancellation scheme. SP1 and SP2 can be any channel estimation algorithms (feedforward or feedback algorithms)

In [P2], [P5], and [P7], the total power of Dedicated Physical Data Channel (DPDCH) is higher than the power of CPICH of approximately 5-10 dB, which means that the power of the CPICH is about 10 % of the transmitted power [13].

The problem of intracell interference estimation (the interference coming from the other users also known as MAI) is very important task in CDMA uplink communication systems. The multiuser detection is an effective method to suppress the MAI and improve the uplink system capacity. The optimal multiuser detector has exponential computational complexity [82], so low complexity suboptimal multiuser detectors have been proposed [83], including

the decorrelating detector [84], MMSE detector, successive interference cancellation (SIC) [85] and parallel interference cancellation (PIC) receivers. In this thesis, the focus is on DL transmission where the receiver has a prior knowledge of the pilot symbols only. In DL-WCDMA a continuous transmitted channel is available, namely the CPICH used for positioning in WCDMA [13].

## 4.5 IMPLEMENTATION ASPECTS OF CDMA RECEIVERS

The major considerations in the implementation of any wireless communication system are the limitations on the power consumption and size of the mobile unit, and the bit-error-rate requirements of various data sources.

Today, the weight of a wireless handset is dominated by the battery. Also, the bulk of the power consumption in a cellular terminal is in the power amplifier of the transmitter [86]. However, as we move towards an era of micro and pico cells, transmit power will drop dramatically and the design of a such system requires both flexibility and reconfigurability. This is achieved by implementing faster and more efficient algorithms to meet the existing standards. Also, the radio interfaces may have to handle multiple modes (multi-mode systems) to allow operation under various standards. At the receiver end, there is a need for continuous collection of received data samples prior to actual processing [86]. This collected data will have to be buffered while actual processing occurs on previously collected data samples. Hence some hardware support such as direct memory access (DMA) is essential for efficient operation.

### 4.5.1 Structure of Wireless Transceiver

The specific nature of wireless communication channels (passbands around high operating frequencies) dictates that almost all transceivers for wireless communications consist of three main parts: a front-end which performs the frequency conversion from passband to baseband or vice versa, a modulator/demodulator, and a baseband processing unit. The design and implementation of these three units are most often considered separately.

In the front-end a high operating frequency and a high input dynamic range is expected. Therefore, analog circuits are dictated to be used [87]. This part mainly consists of mixers, filters and variable gain amplifiers which, in successive stages, filter the antenna signal and down-convert it to lower frequencies. In some current digital systems, the final down-conversion from IF to baseband in the front-end is also performed in the digital domain. The output of the front-end depends on the design of the demodulator. In most of the current digital systems, the output of the front-end are digital, baseband, I (in-phase) and Q (quadrature) signals and the demodulation is performed in a Digital Signal Processor (DSP). The baseband processing, in most cases, is totally in the digital domain, implemented using a combination of DSPs and custom ASICs (application specific integrated circuits) [87].

The DSPs use extensive pipelining, on-chip memories, parallel functional units, separate program and data buses, and specialized instructions such as single cycle multiply-accumulate and bit reversed addressing. DSPs are either floating or fixed point arithmetic devices. Fixed point devices are cheaper, faster, and consume less power. Hence wireless systems, especially handsets, tend to use fixed point devices. Fixed point arithmetic

requires programmers to pay attention to precision, scaling, and overflows due to quantization effects. The choice between DSPs and ASICs is driven by constraints on execution time, cost, and size. Examples of the DSPs that handle baseband processing include Lucent's DSP 16210 [88] and Texas Instruments's (TI's) TMS320C6x and TMS320C5x [89] families of DSPs.

#### 4.5.2 DSP Based Implementation of Channel Estimation Algorithms

In most of the cases, the baseband processing, which include the channel estimation part, is implemented on programmable devices such TI's processors, the fastest of which achieve 1 ns instruction cycle time (for example TMS320C64x processor). A comparison of programmable implementations of both Bayesian algorithms presented in this chapter was given in [P4]. In [90], the authors evaluate the implementation complexity of the most promising feedforward algorithms, namely Teager-Kaiser and POCS algorithms, when using programmable type of platform.

The algorithms are developed and tested with the Code Composer studio of TI. The received signal is generated by MATLAB and saved to a header, where the sampling rate is 4 or 8 samples per chip.

There are different ways to implement efficiently complex algorithms on DSPs. The first one consists of developing the applications interactively using SIMULINK environment [91] in the form of block diagrams. Once the SIMULINK model is built, we can proceed with the automatic generation of C code with the help of Real-Time Workshop from MATLAB [92]. The C code is then compiled by the TMS320C6x C compiler provided by Texas-Instruments [89]. The second method consists of developing applications using C programming language. The program thus developed is compiled and linked using TI compilation tools. This method also accepts programs written in assembler, which can be directly called from the main C program. The third way and the most difficult to handle consists in developing programs directly in assembly language.

The implementation procedure adopted here is based on the second technique. The program can be broken down into different modules, where the "EKF-main" filtering is the core of the algorithm. The program execution time can be speeded up using different levels of optimization ( $-Ox$ ) applied when invoking the compiler. The results in [P4] are given with  $-O3$  and program-level ( $pm$ ) optimizations. The program-level optimization can reduce further the execution time, since all the source files are compiled into one intermediate file called *a module*. Which means, the compiler can see the entire program that allows performing several optimizations which are rarely applied during file-level optimization.

Table 4.1 shows the execution time required for EKF and PF-EKF when using different optimization levels.

**Tab. 4.1:** Execution time (sec), DSP: TMS320C64x@600 MHz  
SF=256,  $N_{BS}=3$ ,  $L = 3$ ,  $N_s = 4$ ,  $N_p = 64$

Optimization level	-O0	-O1	-O2	-O3
EKF	0.0824	0.0632	0.0398	0.0114
PF-EKF	1.6422	0.865	0.365	0.1553

Due to the iterative nature of both EKF and PF algorithms, most of the data generated by the program are stored in internal memory. By storing these data along with the constants into the internal memory, the time taken by the processor to access these data is reduced considerably and the number of cycles to run the code is thus significantly reduced. The results related to memory consumption in [P4] show that both presented algorithms can be implemented with the current state-of-art DSPs. In TMS320C64x@600 MHz processor, the total memory available can be divided to L1/L2 memory architecture<sup>1</sup>. This architecture has 16 kBytes L1P program memory and 16 kBytes L1D data memory, with 256 kBytes L2 unified memory. In table 4.2, it is shown the percentage of memory consumption for different number of paths, with respect to L1 memory only. However, the usage with respect to the overall memory available (i.e., with respect to L1/L2) is much lower.

**Tab. 4.2:** Memory needed for EKF and PF-EKF implementation,  $SF=256$ ,  $N_{BS}=3$ ,  $N_s = 4$ ,  $N_p = 64$

		L=1	L=3	L=5
EKF	Sum (kByte)	5.2	14.4	30.6
	Percentage	16.2 %	45 %	95.6 %
PF-EKF	Sum (kByte)	8.1	22.3	38.8
	Percentage	25.3 %	69.6 %	121.2 %

To reduce further the execution time of PF algorithm, it is possible to exploit the properties of its equations [93]. As it can be seen from [P2] and [P4], the PF is based on Gaussian sampling distribution with mean and variance governed by EKF type of equations. Therefore a nature parallelism of the processing can be based on the number of particles used.

<sup>1</sup>All the variety of the TMS320C64x family have the same L1 memory (32 kBytes PM and DM), but they have different L2 memory architectures for different execution frequencies. For example TMS320C64x@1 GHz has 1024 kBytes L2, and TMS320C64x@500 MHz has 128 kBytes L2.



# Chapter 5

## LOS Detection and Channel Modeling Studies

*This chapter addresses first the problem of identifying the Line-of-Sight and Non-Line-of-Sight situations based on the received signals. Two different link-level approaches will be discussed. The presented algorithms are described in details in [P7]. Second, this chapter discusses the estimation of mobile speed in cellular systems, and it gives an overview of the most widely used techniques in the literature. Next, WCDMA measurement data taken in urban environment is analyzed from mobile positioning point of view. The detailed analysis of the measurement data can be found in [P8]. Finally, author's parallel work on channel modeling in case of indoor reception of GPS positioning satellite signals is summarized.*

### 5.1 INTRODUCTION

In a practical cellular system, two problems arise: first the number of available BSs is always limited, and second, multiple NLOS BSs are likely to occur. It has been shown that even by increasing the correlation time or enforcing an idle period to reduce interference, typically only 3-6 BSs can be heard by the MS at any time [94]. Among those BSs, one cannot assume that the majority are LOS BSs. NLOS propagation will bias the TOA or TDOA measurements even when high-resolution timing techniques are employed and there is no multipath interference. Therefore, it is important to find methods to mitigate the NLOS error. One such method is to distinguish between LOS and NLOS situations.

Earlier work related to LOS detection used range measurement based techniques, which measures the standard deviation of the TOA measurements [49], [50], [51]. The standard deviation of the range measurements is much higher for NLOS propagation than for LOS propagation [50]. By using a priori information about the range error statistics, the range measurements made over a period of time and corrupted by NLOS error can be adjusted to values close to their correct LOS values. An alternate approach is to make algorithmic changes to the location algorithm, to exploit the fact that the range error from NLOS prop-

agation is always positive. This is because the NLOS corrupted TOA estimates are always greater than the direct TOA values [9].

In the earlier literature, no detection algorithms of LOS/NLOS situations have been found and the mitigation has been made based on the assumption of NLOS/LOS cases as worst/best situations [51].

## 5.2 LINK-LEVEL LOS DETECTION

The link level LOS detection where the signal processing is made in the MS side is a new approach presented by the author in [P7]. Based on the estimates obtained from the channel estimator, the author proposes to detect whether the LOS component is present or not. The detection procedure exploits the distribution of the first arriving path. If the distribution is Rician with strong Rician factor, then LOS component is likely to be present. If the distribution is Rayleigh, it is more likely that LOS component is absent. We point out that the proposed algorithm is not limited to the WCDMA system and it can be easily extended to other mobile positioning systems.

### 5.2.1 Curve Fitting Based Approach

The most straightforward method is to estimate the PDF of the first arriving path, and compare it to some reference PDFs such as Rayleigh, Rician, Normal, Lognormal. This approach can be also seen in [95] by Greenwood and Hanzo, and in [96] when applied to real measurement data to estimate the Rician distribution. Also in [97], a study related to fading model selection based on real measurements was presented. The main conclusion there was that there is no unique model, which can provide all the characteristics of the fading phenomenon. In our study, we are interested more in finding methods that can separate between LOS and NLOS cases, and also to see how often these situations may occur in real environments.

To estimate correctly the distribution of the first arriving path, a set of independent fading coefficient amplitudes are needed. We consider that  $N$  independent values are available in the MS memory to be used in the estimation of the channel distribution whenever the positioning is needed. Then, the hypothesis defined by the following equation is tested.

$$P_{meas} \triangleq P_{ref}. \quad (5.1)$$

Here  $P_{meas}$  is the measured PDF and  $P_{ref}$  is the reference PDF (e.g. Rayleigh, Rician,..etc.). From equation (5.1) two states  $H_0$  and  $H_1$  can be formulated as [98]:

$$\begin{cases} H_0 : & P_{meas}(a_i) = P_{ref}(a_i) \quad \text{for } 1 \leq i \leq N \\ H_1 : & P_{meas}(a_i) \neq P_{ref}(a_i) \quad \text{for some } i \end{cases} \quad (5.2)$$

Then, the  $N - 1$  events  $A_i = \{a_{i-1} < x \leq a_i\}$ ,  $i = 1, \dots, N - 1$ , are defined such that  $a_0$  and  $a_{N-1}$  are the smallest and the largest estimates of the channel coefficient, respectively and all the  $a_i$  are equally spaced. The number of successes of  $A_i$  is denoted by  $k_i$  (i.e., the number of samples in the interval  $(a_{i-1}, a_i]$ ).

Under the hypothesis  $H_0$ , the probability of having  $P_{meas}(a_i) = P_{ref}(a_i)$  is defined as

$$\int_{a_{i-1}}^{a_i} P_{meas}(x_i) dx_i \triangleq P(A_i) = \int_{a_{i-1}}^{a_i} P_{ref}(x_i) dx_i. \quad (5.3)$$

Thus, to test the hypothesis in equation (5.1), we form the Pearson's Test Statistic ( $PTS$ ) [98]

$$PTS = \sum_{i=1}^m \frac{(k_i - np_0)^2}{np_0}, \quad (5.4)$$

where,

$$p_0 = (a_i - a_{i-1})P(A_i). \quad (5.5)$$

In equation (5.4),  $n$  is the total number of observed samples ( $n \cong N(\delta\tau)_c/T_s$ ), where  $(\delta\tau)_c$  is the coherence time and  $T_s$  is the sampling interval.

Two criteria for the curve fitting are possible

- **Chi-square test:** the hypothesis  $H_0$  is accepted if the  $PTS$  value satisfies  $PTS < \chi_{1-\lambda}(m-1)$ , where  $\chi_{1-\lambda}(m-1)$  is taken from the standard chi-square tables corresponding to the confidence level  $\lambda$  and to the degree of freedom  $(m-1)$  [98]. For example, by choosing a confidence level of 95% ( $\lambda = 0.95$ ) and degree of freedom 2, the threshold  $\chi_{0.05}(2) = 5.99$ .
- **Minimum PTS:** Here the PTS for each reference PDF (i.e., Rayleigh, Rice, ...etc..) is first evaluated. Then the hypothesis  $H_0$  is accepted for the minimum value of  $PTS$

This technique was shown to be efficient when the observation interval is long enough, i.e., when there is enough independent data samples [P7]. In these cases, accurate detection of LOS and NLOS situation was found. However, when short observation intervals are required or when the MS is in stationary condition, this methods fails to make an accurate decision whether the propagation situation is LOS or NLOS situation.

### 5.2.2 Rician Factor Based Approach

To decrease the duration of the observation and hence the hardware needed for storage, a new algorithm using the estimation of Rician factor parameter was proposed [P7]. The Rician factor  $K^{(v)}$  with respect to the channel profile of the  $v$ -th BS defined by [1]

$$K^{(v)} = \frac{E[a_{1,v}]^2}{2\Omega}, \quad (5.6)$$

where  $a_{1,v}$  is the estimated amplitude of the first arriving path of the  $v$ -th BS, and  $\Omega$  is the average fading power of the scattered paths  $\Omega = \text{Var}[a_{1,v}]$ .

Hereinafter, we consider the case of single BS and the subscript  $v$  will be dropped for convenience. In multiple BSs case, the same procedure is repeated for each BS. When  $K \approx 0$ , ( $K(\text{dB}) \rightarrow -\infty$ ), the distribution is Rayleigh, and NLOS situation should be detected. By considering  $B_{min}$  and  $B_{max}$  as follows, we can define the probability of having LOS situation (respectively NLOS situation):



- $K(dB) \leq B_{min}$ : The distribution is Rayleigh and we set the probabilities

$$(P_{NLOS}, P_{LOS}) \triangleq (1.0, 0.0).$$

- $K(dB) \geq B_{max}$ : The distribution is Rician with strong Rician factor and we set the probabilities

$$(P_{NLOS}, P_{LOS}) \triangleq (0.0, 1.0).$$

- $B_{min} \leq K(dB) \leq B_{max}$ : The probabilities  $P_{NLOS}$  and  $P_{LOS}$  are both different from zero and they can be computed as follows:

1. Divide  $[B_{min}, B_{max}]$  into  $(M + 1)$  equally spaced intervals  $[b_{i-1}, b_i]$ ,  $b_0 = B_{min}$  and  $b_{M+1} = B_{max}$ .
2. for  $i = 1, \dots, M + 1$ ,  
**If**  $b_{i-1} \leq K_r(dB) \leq b_i$  **then**  $(P_{NLOS}, P_{LOS}) \triangleq (\frac{M-i+1}{M}, \frac{i-1}{M})$ .

This algorithm, which is described in details in [P7], shows good performance in detecting LOS and NLOS situations. However, it needs the estimation of the noise level in order to set the adaptive thresholds  $B_{min}$  and  $B_{max}$ .

### 5.3 MOBILE SPEED ESTIMATION

The knowledge of the mobile speed is invaluable to radio resource management. One motivation for mobile speed estimation is that this information can be used to reduce the hand-off rates, which induces an increase in capacity and a decrease in the number of dropped calls. Also for accurate mobile location and location-based added-values services, it is quite important to know the mobile speed. In the literature, there are a few methods of mobile speed estimation that have been published. In [99], [100], [101], [102], the estimation of maximum Doppler frequency is used to estimate the mobile speed. In [103], the diversity switching number is used to estimate mobile speed, but it is pointed out in [104] that this method is highly dependent on the fading distribution statistical properties (Rayleigh fading, Rician fading, etc.). In [105], based on deviation of received signal strength, two methods are proposed to estimate mobile speed for GSM radios. The first one works fine when the channel has no intersymbol interference, and it fails in the presence of intersymbol interference, i.e., dispersive channels. The second method of [105] uses pattern recognition to overcome the limitations of the first method on dispersive channels but leads to high computational complexity and may not be reliable due to the nature of pattern recognition of dispersive channels. In [106], multiple base-station and multidimensional scaling are used to estimate mobile speed; this method may be expensive in practice. In [107], [108], the level crossing rate (LCR) and Average Duration of Fade (ADF) are used to estimate the mobile speed.

It is worth to mention also that when GPS measurements are available, the most straightforward estimation method is based on two or more mobile position estimates. This is achieved by assuming that the mobile speed is constant during a certain interval.

All these cellular network based methods have been presented from the theoretical point of view and they have never been tested, to the author knowledge, on real measurement

data. In [P8] some of these methods were applied in practical situations and the results were compared to the speed estimates based on mobile positions available already through GPS range measurements.

#### 5.4 MEASUREMENT DATA ANALYSIS FOR MOBILE POSITIONING

In this section we analyze the characteristics of the propagation channels in terms of some statistical models of an urban WCDMA channel in the context of mobile phone positioning applications. The motivation comes from the lack of current literature dealing with channel modeling for mobile positioning applications based on real field measurement data in WCDMA systems. Most of the studies related to channel modeling found in the literature so far are related to antenna diversity analysis and to the importance of the good coverage in WCDMA network [109], [110], [111], or to the evaluation of RAKE performance [109], [112], [113].

Few authors addressed the problem of measurement data analysis for mobile positioning purposes. In [114], [115] the authors examine the feasibility and performance of radio location techniques in CDMA cellular networks in up-link direction. However, no specific detection of LOS/NLOS situations were discussed. Nevertheless, the authors in [114] suggested to compensate for non-LOS induced errors by biasing the range estimates as proposed earlier in [49].

The measurement campaign described in [P8] was conducted in the center of Helsinki city, via several trajectories in both microcell and macrocell environments. Four snapshots of the time-varying CIR is shown in Fig 5.1 at 4 time instants. The carrier frequency in UL measurements was  $f_c = 1.935$  GHz and in DL measurements it was  $f_c = 2.125$  GHz, in accordance with 3GPP standards [13]. In order to know the geometry of the measured radio channel at a certain time, LOS and NLOS situations, the position and time were also determined by using the Global Positioning System (GPS). During the measurements, the receiver of the sounder (Rx) was placed at the base station (BS) site. The transmitter (Tx) was moving and the Tx antenna was a modified GSM handset antenna. The measurement campaign was conducted by Nokia personnel and provided to the authors in the form of CIRs.

The aim behind analyzing the measurement data in urban environments is the detection of LOS and NLOS situations based on the link-level approach described earlier. It was shown that LOS component is typically not present in urban environments and the maximum LOS delay error can be as high as few  $\mu s$ . These results were also verified by the estimated offsets between the first arriving peak and the LOS delay estimated via GPS.

Also a comparison between different techniques for the speed estimation and their applicability in the real world was done. It was shown that even in NLOS situations, it is still possible to estimate the mobile speed.

Another interesting observation in [P8] is that in most of the cases, the distribution of the first arriving path matches with the Nakagami- $m$  distribution with quite low  $m$ -factor signaling the NLOS situations.

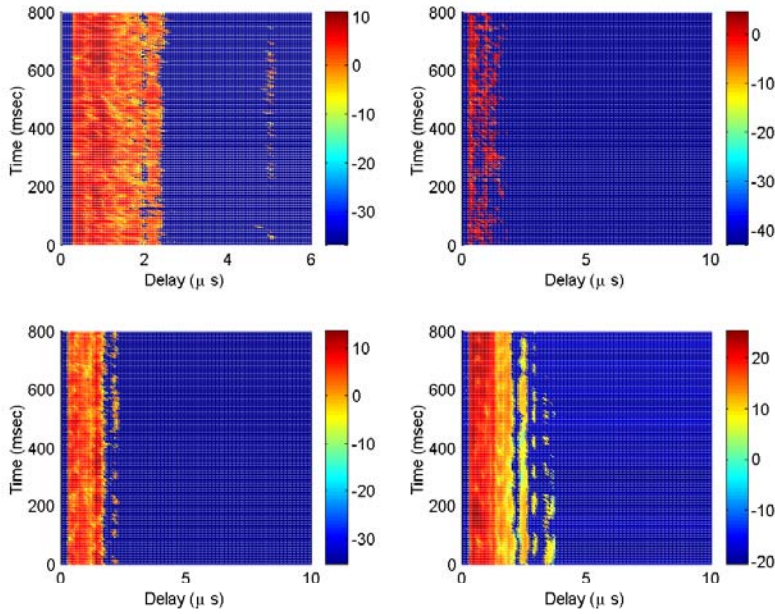

**Fig. 5.1** Four snapshots of the wireless channel impulse response from the city center of Helsinki.

## 5.5 RELATED WORK

In many situations, such as in NLOS situations or in the case of weak signals (for example, in indoor environments), mobile phone positioning in cellular networks becomes a very challenging task. Therefore, there is of great interest to study also satellite based positioning systems in the context of location based mobile services [8]. The new satellite system proposals, such as Galileo [116] and modernized GPS [117], [118], should, in the future, interact with cellular networks for accurate and reliable positioning services<sup>1</sup>. The overall performance of Galileo signals is currently under investigation. The main differences between Galileo signals and the currently transmitted GPS signals include the new modulation scheme: the so-called Binary Offset Carrier (BOC) modulation [119], [120] and the large bandwidth employed for most of the signals. These new standards trigger new challenges in the delay-frequency acquisition and tracking stages. BOC modulations are usually defined via two parameters  $\text{BOC}(m, n)$  [119], related to the reference 1.023 MHz frequency as follows:  $m = f_{sc}/1.023$  and  $n = f_c/1.023$ , where  $f_{sc}$  and  $f_c$  are the sub-carrier frequency and the chip rate, respectively, expressed in MHz. Equivalently, BOC modulations are defined via another set of two parameters, namely the chip rate,  $f_c$ , and the **BOC-modulation order**,  $N_{BOC}$ , which is given by:

$$N_{BOC} \triangleq 2 \frac{m}{n} = 2 \frac{f_{sc}}{f_c}, \quad (5.7)$$

An example of the Power spectrum Density for different BOC-modulated signals is shown in Figure 5.2. While GPS is using BPSK modulation, the BOC modulation has

<sup>1</sup>In the standard of mobile positioning in 3G systems, the AGPS was already selected as an option when the handset has partial GPS receiver

been proposed in [119], [120] in order to improve the spectral efficiency of the L band, by moving the signal energy away from the band center, thus offering a higher degree of spectral separation between BOC-modulated signals and the other signals which use traditional phase-shift-keying modulation. The even-modulation orders ensure a splitting of the spectrum into two symmetrical parts, by moving the energy of the signal away from the RF carrier frequency, and therefore allowing for less interference in the existing GPS bands. The cases with odd modulation index do not suppress completely the interference around the center frequency. For a thorough presentation of Galileo signals and BOC modulation see [119], [120], [117], [121].

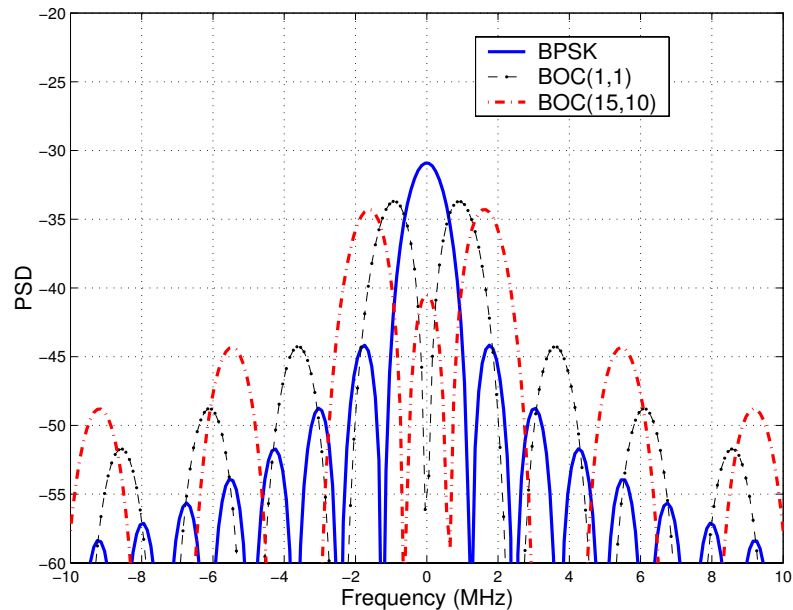
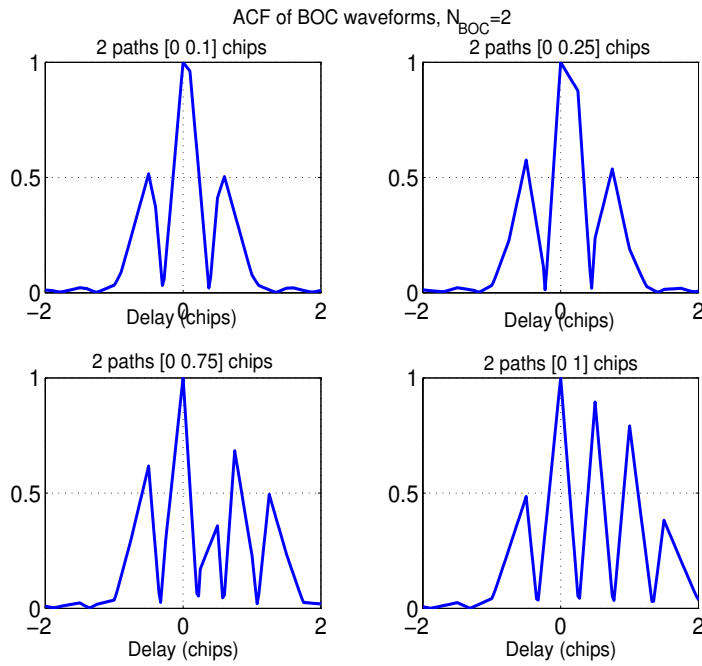

**Fig. 5.2** PSD of several BOC-modulated signals.

Among the challenges that face the researchers at this stage and where the author has contributed can be enumerated as the following:

1. Fast acquisition strategies that take into consideration the features and properties of BOC modulated code sequences. At this level, the author presented new correlation scheme, which exploits the properties of BOC waveforms to reduce the number of operations to be performed. He showed that this structure is more efficient and faster for the implementation than the typical techniques used in GPS and CDMA receivers in general [122]. The choice of acquisition strategy such as serial acquisition [123], parallel or hybrid acquisition [124], [125], [126] is also of utmost concern for fast signal acquisition. In [127] the author presented new acquisition scheme based on the double-dwell strategy for fast acquisition of Galileo signals, which is generalized lately by Lohan & al. in [128] to the multiple dwell case in fading channels.
2. Multipath delay tracking: The use of BOC modulation implies that the autocorrelation function shows multiple peaks, which requires the implementation of dedicated algorithms in the receiver to track the correct (central) peak. Figure 5.3 shows examples of the autocorrelation functions of BOC waveforms with 2 closely spaced

paths. It is clear from this simple example that resolving multipath components becomes very challenging task because of different side lobes of the correlation function and closely-spaced paths situations. In Figure 5.4, it is shown the deformation of an



**Fig. 5.3** Examples of the autocorrelation functions of BOC waveforms with 2 closely spaced paths for  $N_{BOC} = 2$ .

Early-minus-Late discriminator by the influence of an overlapping multipath.

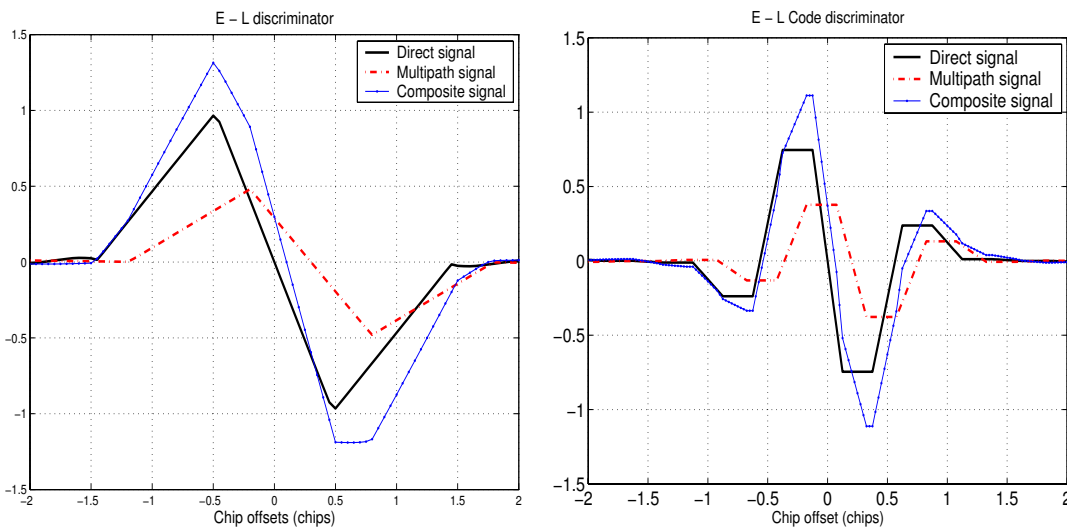

**Fig. 5.4** Deformation of an Early-minus-Late discriminator by the influence of an overlapping multipath. Left: BPSK modulation, the correlator spacing between early code and late code is 0.5. Right: BOC modulation with  $N_{BOC} = 2$ , the correlator spacing between early code and late code is 0.05.

Tracking of BOC signals is discussed in [120] and extended lately by the author to the closely-spaced path situation in [90] using feedforward approach. This scenario of overlapping paths is likely to be encountered in indoor positioning applications or in outdoor urban environments. The use of feedback based structures such as the EKF or SMC based estimators seems to be difficult in acquisition mode due to the wide searching domain, which is directly related to the code epoch length<sup>2</sup> and Doppler frequency range. However, in tracking mode, where the searching space is limited to few frequency bins and to few tens of chips, both algorithms can be used in the same way as in WCDMA.

3. Indoor channel modeling for GPS system: The wireless enhanced 911 (E-911) services [129], [114] and GPS [58], which are mostly used in open air environments, cannot provide accurate indoor geolocation. Therefore, it is of utmost importance to understand the behavior of the satellite-to-indoor channel propagation to improve the positioning capabilities in indoor reception.

In the literature, indoor reception of GPS positioning satellite signals is still an open research topic. Typical modeling studies are based on the use of pseudolites to simulate the satellites as discussed in [130], [131]. The use of the real satellite signals to model the indoor channel propagation encounter different challenges. The most difficult one is the path loss due to the wall penetration which result into very weak signals making the multipath identification quite difficult. At this level the author studied the indoor channel modeling based on satellite signals [132]. In this context, the multipath identification, type of propagation (i.e., distant or closely-spaced paths), and LOS detection in indoor propagation have been often neglected in the literature.

Figures 5.5 and 5.6 show two examples of indoor multipath phenomena, where both distant paths and closely spaced paths may occur. The analysis of real measurement data showed that the case of closely-spaced paths occur quite often in indoor environments with a rate of up to 60% in some cases [132]. These observations show the importance of considering the case of overlapped paths in the channel estimation model, as it is done in this thesis.

Another interesting observation related to indoor channel propagation shows that the distribution of the strongest path matches with the Nakagami- $m$  distribution in indoor and outdoor environments. In indoor, the  $m$  factor is quite low signaling the absence of LOS situations [132].

One open issues here are the analysis of the inter-satellites interference, especially when using pseudolites for assisting the indoor positioning, as well as the multipath identification indoors.

<sup>2</sup>In GPS and the new proposal for Galileo, the code epoch length is an integer multiple of 1023 chips

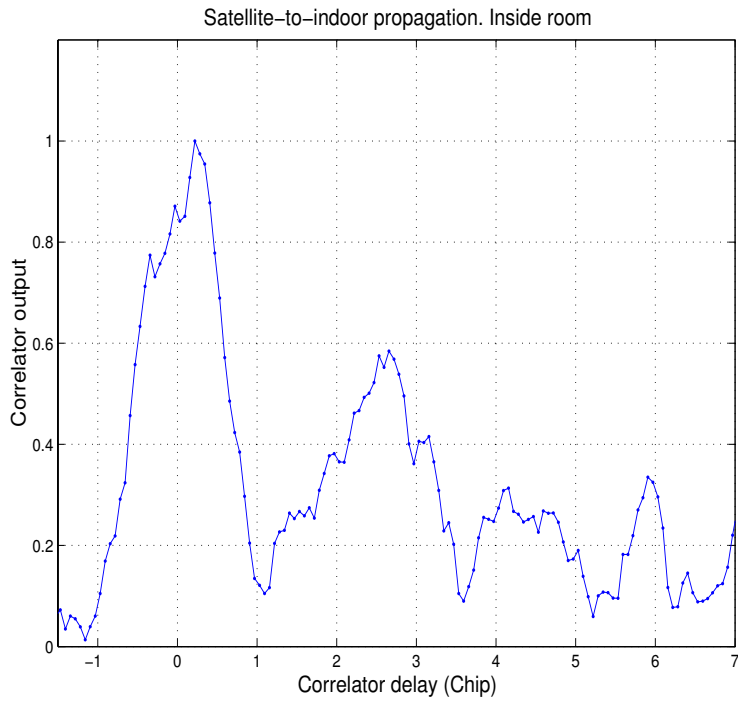

**Fig. 5.5** Snapshot of the correlator output at 2 time instants in indoor propagation. Signal coming from GPS satellite. Case of 2 distant paths.

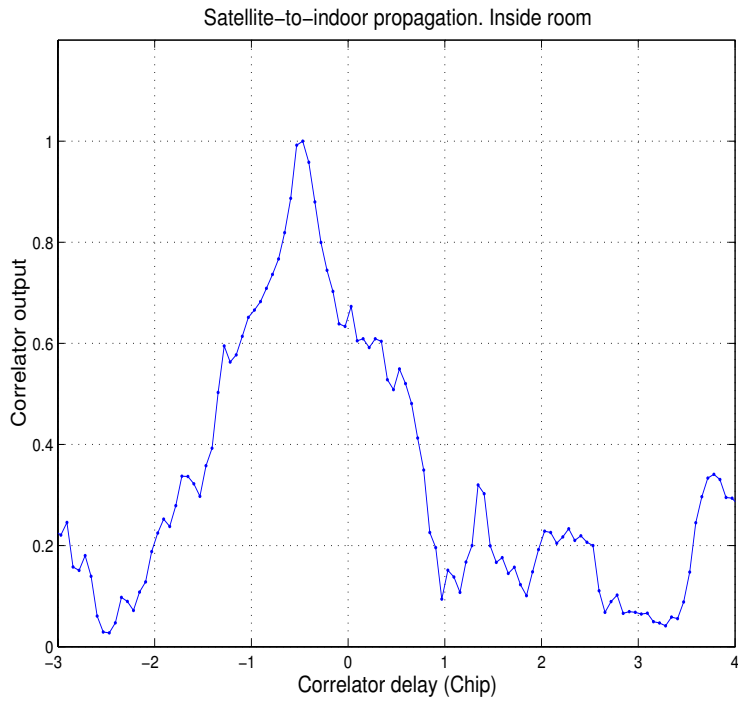

**Fig. 5.6** Snapshot of the correlator output at 2 time instants in indoor propagation. Signal coming from GPS satellite. Case of 2 overlapping paths.

# Chapter 6

## Summary of Publications

### 6.1 GENERAL

This thesis includes eight publications [P1]-[P8]. They can be categorized under three main topics according to the subject of the research:

1. Bayesian approach for channel estimation has been investigated and different techniques have been analyzed. Here, the study started from the work done by Iltis in 1990 [31] to estimate jointly the first arriving path and the detectable complex channel coefficients. This work was extended to the multipath case in downlink WCDMA and later to the Sequential Monte Carlo based estimation. This work was also extended to provide a parallel interference cancellation technique to enhance the estimation of the first arriving path.
2. Several feedforward based channel estimators were investigated and analyzed. Here the study started from the work done by my two co-authors; Dr. Ridha Hamila [27] and Dr. Elena-Simona Lohan [28]. The work was extended to estimate jointly the channel coefficients and multipath delays using a deconvolution approach. Based on this scheme also a feedforward architecture with parallel interference cancellation was developed. Also the work done on Teager-Kaiser operator based channel estimation in the GPS case, with unlimited bandwidth, was extended to the case of limited bandwidth (the case of downlink WCDMA) by introducing a new deconvolution block in the channel estimator structure.
3. New techniques for Line of Sight detection were introduced and analyzed. These techniques, which are based on the statistical properties of the fading channel, were investigated through simulations and analysis of real measurement data. A related topic to LOS detection is the mobile speed estimation which was discussed analytically and the performance of alternative methods was tested using real measurement data.

According to this classification, five papers consider Bayesian channel estimation [P1]-[P4], [P7]. Two papers consider feedforward based channel estimation [P5], [P6], and two



papers consider the LOS detection and measurement data analysis for mobile positioning applications [P7], [P8].

## 6.2 OVERVIEW OF THE PUBLICATION RESULTS

In publication [P1], Extended Kalman filter is used for downlink channel estimation in single BS case. Here we developed the system model in order to estimate jointly the channel coefficients and delays of all detectable paths. The estimation is done both at the sample and symbol levels. The impact of initialization error is also emphasized.

In publication [P2], the Extended Kalman filter based estimation is extended to the case of multiple BSs where all the detectable paths from all the BSs are estimated. This structure is combined with a parallel intercell interference cancellation scheme to enhance the estimation of the first arriving path from each BS.

In publication [P3], new technique for estimating jointly the channel coefficients and multipath delays based on Sequential Monte Carlo theory is introduced. The scenario of single and multiple BSs was investigated. The impacts of initialization error and the path separation are also emphasized.

In publication [P4], a comparison between SMC and EKF approaches is presented. The comparison was carried out from the point of view performance, and implementation complexity when programmable DSPs are chosen as implementation platform.

The analysis in [P1]-[P4] showed that Bayesian-based approaches for joint channel estimation is efficient in downlink WCDMA. EKF algorithm is quite simple for the implementation but it showed some limitation and inaccuracies in converging, due mostly to bad initialization. In the other hand, SMC filters showed good performance in tracking the channel parameters. They are more stable than the EKF with respect to the initialization parameters. However, they are more complex to implement.

Based on the idea presented in publication [P2], we introduced a new interference cancellation scheme based on deconvolution approach. This idea has been discussed in publication [P5]. Here the performance comparison between the channel estimation schemes with and without parallel interference cancellation is included.

In publication [P6], a new efficient technique for channel estimation based on the non-linear Teager Kaiser operator was presented, the so-called GTK method. Here we modified the earlier work of the co-authors presented for unlimited bandwidth to introduce new deconvolution approach for enhanced LOS estimation in bandlimited case. A comparison of different feedforward approaches such as MUSIC, LS, TK algorithms for channel estimation was also carried out and showed clear superiority of the GTK method.

In publication [P7], a single framework for LOS estimation and detection was presented. Here we mean by LOS estimation the estimation of the delay of the first arriving path and we mean by LOS detection the decision whether the first arriving path corresponds to LOS or NLOS situation. The estimation of the LOS signal is done via the Extended Kalman filter combined with intercell interference cancellation block followed by LOS detection algorithms. The LOS detection exploits the statistical properties of the estimated channel. These algorithms are based on curve fitting and the properties of Rician distribution parameter.

In publication [P8], a single framework for real measurement data analysis for mobile positioning applications was described. The measurement data were collected in typical

urban environment in the city center of Helsinki, Finland via several trajectories in both microcell and macrocell environments. The focus here is on the estimation of the first arriving path and its corresponding distribution. We verified whether the first arriving path corresponds to LOS or NLOS situation, and we estimated the mobile speed using different algorithms.

Here, the detection of LOS component and the amplitude distribution of the first arriving path are obtained based on the algorithms presented in [P7]. The mobile speed estimation is conducted based on known techniques found in the literature [99], [100], [101], [102]. However, they have never been tested, to the author's knowledge, on real measurement data and compared to the true speed.

These analysis showed that the LOS component is very rare in urban environments and that the distribution of the first arriving path typically matches with the Nakagami-m fading or Rician fading with very low factors. The analysis showed also that, in urban environment, the number of multipath components can be quite high (with an average of 5 paths). Furthermore, we saw that we are able to obtain reliable speed estimates regarding whether the mobile is moving at a low speed or a high speed, even if the statistical distribution of the first path amplitude does not match with the Rician or Rayleigh distributions.

### 6.3 AUTHOR'S CONTRIBUTIONS TO THE PUBLICATIONS

The research work done during the course of this thesis was carried out at the Institute of Communications Engineering (formerly Telecommunications Laboratory), Tampere University of Technology as one member of an active and productive research group involved in analyzing and developing different algorithms for CDMA network and satellite based positioning systems. The whole project has been supported and guided by the thesis supervisor Prof. Markku Renfors.

Many of the ideas have originated in informal discussions within the group and some of the simulation models have been designed in cooperation with the co-authors. Therefore, the author's contribution cannot be separated completely from the contribution of the co-authors. However, the author's contribution to all of the publications included in this thesis has been essential in the sense that he developed the main theoretical framework, performed most of the simulations, analyzed, and prepared the manuscripts. We point out here that naturally the co-authors contributed to the final appearance of each article.

The main contributions of the author to the publications are as follows:

In [P1], the author formulated the theoretical background of joint estimation of complex channel coefficients and multipath delays using the Extended Kalman Filter. He also developed the simulation programs and wrote the manuscript. The idea of using EKF for channel estimation came from an informal discussion within the group.

In [P2], the author formulated the interference cancellation idea and included it in the framework of EKF based channel estimation. The author developed the simulation models and wrote the manuscript. The idea of inter-cell interference cancellation belongs to Dr. Elena-Simona Lohan.

In [P3], the author took the initiative to explore the direction of SMC based channel estimators. They have been introduced to the author for the first time by Prof. Markku Renfors.

The author formulated the theoretical background and developed the simulation models. The manuscript was written by the author.

In [P4], the author came with the idea of comparing the complexity of EKF and SMC based estimation approaches using programmable DSPs of Texas Instruments. The author developed the implementation algorithms in C and assembly languages. He analyzed the results and wrote the manuscript.

In [P5], the author proposed the idea of interference cancellation algorithm based on the deconvolution approach. The simulation models are based on the models developed by the co-author. The manuscript is prepared by the author.

In [P6], the author formulated the theoretical background of the Generalized Teager Kaiser idea with the help of the first author. However, the author implemented all the simulation models, analyzed the results and wrote the manuscript. The idea of GTK belongs to Dr. Ridha Hamila.

In [P7], the author developed the LOS detection algorithms and analyzed the results. The curve fitting-based LOS detection idea was originally proposed by Dr. Lohan and Rician parameter based LOS detection was the idea of the author. The author combined the channel estimation algorithms using IC technique and LOS detection. The author conducted the experiment analysis and wrote the manuscript.

In [P8], the idea of analyzing the real data measurement for mobile positioning applications came from our industrial partner. The author is the co-developer of the simulation analysis of the measurement data. The estimation of the mobile speed was the initiative of the first author who wrote all the simulation algorithms for this part. The author wrote about half of the manuscript.

# Chapter 7

## Conclusions and Further Work

In this thesis we have addressed the problem of channel estimation and mobile phone positioning for CDMA communication systems over multipath fading channels.

In Chapter 1, the problematics, the motivation, and the prior work were introduced. The channel and signal models were described in Chapter 2 by explaining all the parameters used. The focus was on downlink WCDMA system. However, the extension to the general case of CDMA system is straightforward. In chapter 3, an overview of the positioning technologies employed in cellular systems are also described.

In Chapter 4, an overview of the main methods for estimating jointly the complex channel coefficients and multipath delays was given. The emphasis was on two classes of estimators, namely the Bayesian based and feedforward based approaches. The focus here was on sub-chip accuracy of LOS signal, which is required for mobile positioning applications. We also presented a parallel interference cancellation scheme that can be coupled to the channel estimator to improve the estimation of the LOS signal. We also discussed the programmable implementation of some of these techniques using TI's DSPs.

For the Bayesian approach we compared two classes of estimators. The first one is based on the Extended Kalman filter which is a suboptimal estimator that linearizes locally the nonlinear variable before applying the optimal solution, namely the Kalman filter [66]. The local linearization has been shown to introduce some inaccuracies and may lead to a divergence of the algorithm [P1]. Thus we introduced a new class of filters, which are based on the Sequential Monte Carlo simulation to overcome to these inaccuracies. These filters use a set of discrete samples in order to approximate the probability density function of the state variables. They have the ability to handle Gaussian as well as non-Gaussian systems. In the joint estimation of complex channel coefficients (linear variable) and multipath delays (nonlinear variable), it is possible to sample only from the nonlinear variable [P4], [33], and use Kalman filter in order to estimate the complex channel coefficients or it is possible to sample from the joint variable which include both linear and non-linear parameters [P3].

The analysis showed a clear superiority of SMC filters based estimators over the generic EKF algorithms from the point view of stability and the time to converge [P3],[P4]. However, when considering programmable type of implementation using TI DPSs, the SMC filters are far more complex to implement. The execution time and the memory consump-

tion are increasing exponentially with the number of particles used in the approximation. Therefore, Bayesian approaches may be used up to a certain extent to solve the problem of closely-spaced paths. For example when the computation power is not a limiting factor, as it is the case for the fixed BS side, it is quite efficient to use EKF or SMC filters for the channel estimation.

For the feedforward approaches, the focus was mostly on the multipath delay estimation. The impact of using bandlimiting pulse shaping, such as the one used in downlink WCDMA system was also emphasized. We proposed new and efficient deconvolution technique to overcome the inaccuracies introduced by the bandlimiting filters when using the Teager-Kaiser operator for multipath delay estimation. The new deconvolution technique denoted by Generalized Teager Kaiser method showed good performance on estimating the LOS component with sub-chip accuracy [P6]. In this context, different algorithms were analyzed and compared. From the point of view performance, GTK, and POCS algorithms seem to have the best performance in term of acquiring correctly the delay of the first arriving path [P5]-[P6]. However, from the point of view of implementation complexity, TK and GTK seem to have the best performance. POCS algorithm have also the advantage of estimating jointly the complex channel coefficients and multipath delays, which make it a good candidate for IC scheme [P5]. In asynchronous networks, OTDOA-IPDL has been approved for standardization for mobile positioning in 3G networks [12], [61], [62]. In this context, the MS measures links of different BSs in order to be able to compute its own position. Such scenario exhibits strong interference from neighboring BSs and special techniques to reduce this inetr-cell interference have to be provided. Two techniques of parallel interference cancellation were provided in [P2] and [P5] based on Bayesian approach and deconvolution techniques, respectively. The key issue is to estimate jointly the multipath delays and complex channel coefficients of all the detectable paths of all the BSs channels, which are in the vicinity of the MS. This joint estimation will make possible the estimation of the interference and further enhancement of the the LOS signal becomes straightforward.

However, the mobile station needs to estimate quite accurately the time of arrival simultaneously from different base stations (BSs). In many cases, it may happen that the direct signal is obstructed by the NLOS components, and the first arriving path may not be the direct signal. This situation usually introduces errors in the position estimates. Therefore, it is quite important to detect whether the first arriving path corresponds to LOS or NLOS case. In Chapter 5, detection of LOS signal is analyzed and tested based on simulation and on real measurement data. The link level LOS detection where the signal processing is made on the MS side is new approach [P7]. Based on the estimates obtained from the channel estimator, it is possible to detect whether the LOS component is present or not. The detection procedure exploits the distribution of the first arriving path. If the distribution is Rician with strong Rician factor, then LOS component is likely to be present. If the distribution is Rayleigh, it is more likely that LOS component is absent. In the later case, the open issues are how to correct the NLOS errors for accurate position estimation.

For the LOS detection and channel modeling, the study was based on real measurement data that has been collected in the center of Helsinki city, via several trajectories in both microcell and macrocell environments. The motivation behind this study comes from the lack of current literature dealing with channel modeling specifically for mobile positioning applications. The analysis of the measurement data showed that the LOS component is typically not present in urban environments and the maximum LOS error can be as high as few

$\mu s$ . The same results were verified by the estimated offsets between the first arriving peak and the LOS estimated via GPS measurements. The analysis of measurement data showed also that the distribution of the first arriving path typically matches with the Nakagami-m fading or Rician fading with very low factors, declaring again the absence of direct component. It was shown also that the number of multipath components can be quite high in urban environments (with an average of 5 paths) [P8]. The estimation of mobile speed showed also a good robustness to the multipath propagation and even if the statistical distribution of the first path amplitude does not match with the Rician or Rayleigh distributions, a reliable estimates are obtained.

A summary of the presented publications was given in Chapter 6, where the author's contributions to the presented work are emphasized.

## 7.1 FURTHER WORK AND DIRECTIONS

The estimation of the multipath delays is an important task in any spread spectrum receiver, not only for positioning applications, but also for other baseband receiver blocks, such as the Rake combining, the interference cancellation, etc. The new satellite-based positioning system proposals, such as Galileo and modernized GPS, specify the use of new modulation types, such as the Binary Offset Carrier (BOC) modulation, which trigger new challenges in the delay-frequency acquisition and tracking stages. The features and properties of BOC-modulated code sequences are still not well-understood in the context of delay estimation in the presence of fading multipath channels, and more important, when the multipath channels are closely spaced, which is likely to be often encountered in indoor positioning applications or in outdoor urban environments.

Another important direction that is currently under investigation, is the indoor channel modeling in satellite system based positioning. This work is based on the signals coming from GPS satellites. However, similar conclusions are expected to be valid in the presence of the future Galileo satellites that have to be deployed before the year 2008. Multipath identification and modeling (such as number of paths, spacing between them, etc.) in indoor scenario is a very important research topic for accurate deployment of the future satellite-based mobile positioning services.

It remains as challenging topic for future work also the problem of extending the studied algorithms and theory in the context of the future broadband mobile communications systems (4G wireless communication system) expected to be deployed around the year 2010. The goal is to attain higher throughput for packet data in particular in downlink, without unnecessary bandwidth expansion and while providing acceptable quality of service for various classes of traffic.



# References

- [1] T. Rappaport, *Wireless communications: Principles and practice*. Prentice Hall, 1996.
- [2] J. Proakis, *Digital communications*. New York: McGRAW-Hill International Edition, 4th ed., 2001.
- [3] M. K. Simon and M. S. Alouini, *Digital communications over fading channels: a unified approach to performance analysis*. USA: John Wiley and Sons Inc., 2000.
- [4] J. Lee and L. Miller, *CDMA systems engineering handbook*. Artech House, 1998.
- [5] B. Chytil, "The distribution of amplitude scintillation and the conversion scintillation indices," *J. Atmos. Terr. Phys.*, vol. 29, pp. 1175–1177, Sep 1967.
- [6] A. U. Sheikh, M. Handforh, and M. Abdi, "Indoor mobile radio channel at 946 MHz: Measurements and modeling," in *Proc. of IEEE Vehicular Technology Conference*, pp. 73–76, May 1993.
- [7] A. Abouraddy and S. M. Elnoubi, "Statistical modeling of the indoor radio channel at 10 GHz through propagation measurements. part i: Narrow-band measurements and modeling," *IEEE Transaction on Vehicular Technology*, vol. 49, pp. 1491–1507, Sep. 2000.
- [8] J. Syrjärinne, *Studies of modern techniques for personal positioning*. PhD thesis, Tampere University of Technology, Tampere, Finland, March 2001.
- [9] J. Caffery and G. Stuber, "Overview of radiolocation in cdma cellular systems," *IEEE Communications Magazine*, vol. 36, pp. 38–45, April 1998.
- [10] J. Caffery, "Parameter estimation in DS-CDMA systems," tech. rep., Georgia Institute of Technology, June 1995. Report.
- [11] M. Vimpari, *Base Station availability for location services in GSM network*. Lic. th., University of Oulu, 2001.



- [12] M. Cedervall, "Mobile positioning for third generation WCDMA systems," in *Proc. of IEEE 1998 International Conference on Universal Personal Communications*, vol. 2, pp. 1373–1377, Oct. 1998.
- [13] 3GPP. *Physical Layer-General Description, 3GPP Technical Report TS 25.201 V3.0.0*, Oct. 1999.
- [14] T. Ojanpera and R. Prasad, *Wideband CDMA for third generation mobile communications*. Artech House, Oct. 2001.
- [15] J. Reed, K. Krizman, B. Woerner, and T. Rappaport, "An overview of the challenges and progress in meeting the E-911 requirement for location service," *IEEE Communications Magazine*, vol. 36, no. 4, pp. 30–37, 1998.
- [16] E. R. Játiva and J. Vidal, "GLRT detector for NLOS error reduction in wireless positioning systems," in *CD-ROM Proc. of IST Mobile and Wireless Telecommunications Summit*, Nov. 2002.
- [17] N. Yousef and A. Sayed, "Detection of fading overlapping multipath components for mobile positioning systems," in *Proc. of IEEE International Conference on Communications*, vol. 10, pp. 3102–3106, June 2001.
- [18] E. Strom, S. Parkvall, S. Miller, and B. Ottersten, "Propagation delay estimation in asynchronous direct-sequence code-division multiple access systems," *IEEE Transactions on Communications*, vol. 44, pp. 84–93, Jan. 1996.
- [19] T. Ostman, S. Parkvall, and B. Ottersten, "Improved MUSIC algorithm for estimation of time delays in asynchronous DS-CDMA systems," in *Proc. of Asilomar Conf. of Signals, Systems and Computers*, vol. 1, pp. 838–842, Nov. 1997.
- [20] E. Lohan, R. Hamila, and M. Renfors, "Superresolution algorithms for detecting overlapped paths in DS-CDMA systems with long codes," in *Proc. of IEEE International Symposium on Personal, Indoor and Mobile Radio Communications*, vol. 1, (4), pp. 1919–1923, Sep. 2002.
- [21] M. Hahm, Z. Mitrovski, and E. Titlebaum, "Deconvolution in the presence of doppler with application to specular multipath parameter estimation," *IEEE Transactions on Signal Processing*, vol. 45, pp. 2203–2219, Sep. 1997.
- [22] N. Yousef and A. Sayed, "A new combined architecture for CDMA location searchers and rake receivers," in *Proc. of IEEE International Symposium on Circuits and Systems*, pp. 101–104, May 2000.
- [23] N. Yousef and A. Sayed, "Robust multipath resolving in fading conditions for mobile positioning systems," in *Proc. of IEEE Radio Science Conference*, pp. C19/1–C19/8, Feb. 2000.
- [24] Z. Kostic and G. Pavlovic, "Resolving sub-chip spaced multipath components in CDMA communication systems," in *Proc. of IEEE Vehicular Technology Conference*, vol. 1, pp. 469–472, May 1993.

- [25] Z. Kostic and G. Pavlovic, "CDMA RAKE receiver with sub-chip resolution." US Patent Publication, July 1997. US5648983 (Lucent Technologies).
- [26] D. Colclough and E. Titlebaum, "Delay-doppler POCS for specular multipath," in *Proc. of IEEE International Conference on Acoustics, Speech, and Signal Processing*, vol. 4, pp. 3940–3943, May 2002.
- [27] R. Hamila, *Synchronization and Multipath Delay Estimation Algorithms for Digital Receives*. PhD thesis, Tampere University of Technology, Tampere, Finland, June 2002.
- [28] E. S. Lohan, *Multipath delay estimators for fading channels with applications in CDMA receivers and mobile positioning*. PhD thesis, Tampere University of Technology, Tampere, Finland, Oct. 2003.
- [29] M. Guenach and L. Vandendorpe, "Downlink performance analysis of BPSK-based WCDMA using conventional RAKE receivers with channel estimation," *IEEE Journal on Selected Areas in Communications*, vol. 19, pp. 2165–2176, Nov 2001.
- [30] *FCC docket No. 94-102, Fourth memorandum Opinion and Order*, Sep. 2000.
- [31] R. Iltis, "Joint estimation of PN code delay and multipath using the extended Kalman filter," *IEEE Transactions on Communications*, vol. 38, no. 10, pp. 1677–1685, 1990.
- [32] R. A. Iltis and S.-J. Kim, "A mean-value theorem-based particle filter for nonlinear estimation," in *CD-ROM Proc. of Annual Conference on Information Sciences and Systems*, 2002.
- [33] R. Iltis, "A sequential monte carlo filter for joint linear/nonlinear state estimation with application to DS-CDMA," *IEEE Transactions on Signal Processing*, vol. 51, pp. 417–426, Feb. 2003.
- [34] M. Guenach, *Receiver design for wideband CDMA communications systems*. PhD thesis, Universite Catholique de Louvain, April 2002.
- [35] D. Salmond, N. Gordon, and A. Smith, "Novel approach to nonlinear/non gaussian bayesian state estimation," *IEE proceedings - F*, vol. 140, no. 2, pp. 107–113, 1993.
- [36] A. Doucet, N. de Freitas, and N. Gordon, *On sequential monte carlo methods in practice*. New York: Springer, 2001.
- [37] A. Doucet, N. Gordon, and V. Kroshnamurthy, "Particle filters for state estimation of jump markov linear systems," *IEEE Transactions on Signal Processing*, vol. 49, pp. 613–624, Mars 2001.
- [38] M. Arulampalam, S. Maskell, N. Gordon, and T. Clapp, "A tutorial on particle filters for online nonlinear/non-gaussian bayesian tracking," *IEEE Transactions on Signal Processing*, vol. 50, pp. 174–188, Feb. 2002.
- [39] R. V. Nee, J. Sierveveld, P. Fenton, and B. Townsend, "The multipath estimating delay locked loop: approaching theoretical accuracy limits," in *Proc. of IEEE Position Location and Navigation Symposium*, vol. 1, pp. 246–251, April 1994.

- [40] K.-C. Chen and L. Davisson, "Analysis of SCCL as a PN-code tracking loop," *IEEE Transactions on Communications*, vol. 42, pp. 2942–2946, Nov 1994.
- [41] M. Latva-Aho and J. Vallstrom, "Quasi-coherent delay-locked loops for fading channels," in *Proc. of IEEE International Symposium on Spread Spectrum Techniques and Applications*, vol. 1, pp. 455–459, Sep. 1996.
- [42] R. Hamila, E. Lohan, and M. Renfors, "Subchip multipath delay estimation for downlink WCDMA system based on Teager-Kaiser operator," *IEEE Communications Letters*, vol. 7, pp. 1–3, Jan. 2003.
- [43] P. Luukkanen and J. Joutsensalo, "Comparison of music and matched filter delay estimators in DS-CDMA," in *Proc. of IEEE International Symposium on Personal, Indoor and Mobile Radio Communications*, vol. 3, pp. 830–834, Sep. 1997.
- [44] A. Jakobsson, A. L. Swindlehurst, and P. Stoica, "Subspace based estimation of time delays and doppler shifts," *IEEE Transactions on Signal Processing*, vol. 24, pp. 2472–2483, Sep. 1998.
- [45] G. Fock, J. Baltersee, P. Schulz-Rittich, and H. Meyr, "Channel tracking for RAKE receivers in closely spaced multipath environments," *IEEE Journal on Selected Areas in Communications*, vol. 19, no. 12, pp. 2420–2431, 2001.
- [46] G. Fock, P. Schulz-Rittich, J. Baltersee, and H. Meyr, "Multipath resistant coherent timing error detector for ds-cdma applications," in *Proc. of IEEE Sixth International Symposium on Spread Spectrum Techniques and Applications*, vol. 1, pp. 278–282, Sep. 2000.
- [47] J. Baltersee, G. Fock, and P. Schulz-Rittich., "Adaptive code tracking receivers for DS-CDMA communications over multipath fading channels and methods for signal processing in a RAKE receivers." US Patent Application Publication, Aug. 2001. US 2001/0014114.
- [48] H. Boujemaa and M. Siala, "Enhanced coherent delay tracking for DS spread spectrum systems," in *Proc. of IEEE Sixth International Symposium on Spread Spectrum Techniques and Applications*, vol. 1, pp. 274–277, Sep. 2000.
- [49] M. Wylie and J. Holtzman, "The non-line of sight problem in mobile location estimation," in *Proc. of IEEE International Conference on Universal Personal Communications*, vol. 2, pp. 827–831, Oct. 1996.
- [50] M. Wylie and J. Holtzman, "Method and system for mobile location estimation." US Patent Application Publication, Oct. 1999. US 005974329A (Rutgers University, NJ).
- [51] P. Chen, "Mobile position location estimation in cellular systems," Technical Report WINLAB-TR-181, Rutgers University, 1999.
- [52] W. Rumlner and M. Liniger, *Multipath fading channel models for microwave digital radio in terrestrial digial microwave Communication*. Artech House., 1989.

- [53] P. Bello, "Characterization of randomly time-variant linear channels," *IEEE Transactions on Communications*, vol. 11, pp. 360–393, Dec 1963.
- [54] W. Jakes, *Microwave mobile communications*. USA: John Wiley and Sons Inc., 1974.
- [55] S. Glisic and B. Vucetic, *Spread spectrum CDMA systems for wireless communications*. Artech House Publishers, 1997.
- [56] A. Coulson, A. Williamson, and R. Vaughan, "Improved fading distribution for mobile radio," *IEE Proceedings on Communications*, vol. 145, pp. 197–202, June 1998.
- [57] A. Coulson, A. Williamson, and R. Vaughan, "A statistical basis for lognormal shadowing effects in multipath fading channels," *IEEE Transactions on Communications*, vol. 46, no. 4, pp. 494–502, 1998.
- [58] E. Kaplan, *Understanding GPS, Principles and applications*. Boston: Artech House, 1996.
- [59] G. Hein, M. Irsigler, J. A. A. Rodriguez, and T. Pany, "Performance of galileo L1 signal candidates," in *CD-ROM Proc. of The European Navigation Conference (ENC-GNSS'04)*, 2004.
- [60] E. Commission, "The Galilei project - GALILEO design consolidation," tech. rep., European Space Agency, Aug. 2003.
- [61] T. Rappaport, J. H. Reed, and B. Woerner, "Position location using wireless communications on highways of the future," *IEEE Communications Magazine*, vol. 34, pp. 33–41, Oct. 1996.
- [62] 3GPP, "Recapitulation of the IPDL positioning method," tech. rep., Source: Ericsson, April 1999.
- [63] H. Suzuki, "A statistical model of urban mutipath propagation," *IEEE Transactions on Communications*, vol. 25, pp. 673–680, July 1997.
- [64] W. Braun and U. Dersch, "A physical mobile radio channel model," *IEEE Transaction on Vehicular Technology*, vol. 40, pp. 472–482, May 1991.
- [65] S. Haykin, ed., *Kalman filtering and neural networks*. Wiley Publishing, 2001.
- [66] R. Kalman, "A new approach to linear filtering and prediction problem," *Basic Engineering*, no. 82, pp. 35–45, 1960.
- [67] J. K. Kyeong and R. Iltis, "Joint detection and channel estimation algorithms for QS-CDMA signals over time-varying channels," *IEEE Transactions on Communications*, vol. 50, no. 5, pp. 845–855, 2002.
- [68] B. D. O. Anderson and J. B. Moore, *Optimal Filtering*. Englewood Cliffs, NJ, Prentice-Hall, 1979.
- [69] C. Komninakis, C. Fragouli, A. Sayed, and R. Wesel, "Channel estimation and equalization in fading," in *Proc. of Asilomar Conference on Signals, Systems, and Computers*, vol. 2, pp. 1159–1163, Oct. 1999.

- [70] T. Lim and L. Rasmussen, "Adaptive symbol and parameter estimation in asynchronous multiuser CDMA detectors," *IEEE Transactions on Communications*, vol. 45, no. 2, pp. 213–220, 1997.
- [71] P. Diaz and R. Agusti, "Design and implementation of an EKF-based tracking synchronism scheme for an indoor DS/CDMA system," in *Proc. of IEEE Vehicular Technology Conference*, vol. 1, pp. 601–605, May 1996.
- [72] J. S. Julier and J. K. Uhlmann, "A new extension of the kalman filter to nonlinear systems," in *Proc. of International Symposium on Aerospace/Defense Sensing, Simulation, and Control*, pp. 1628–1632, 1997.
- [73] Z. Kostic and G. Pavlovic, "Resolving sub-chip-spaced multipath components in CDMA communications systems," *IEEE Transaction on Vehicular Technology*, vol. 48, no. 6, pp. 1803–1808, 1999.
- [74] Z. Kostic, M. I. Sezan, and E. Titlebaum, "Estimation of the parameters of multipath channel using set-theoretic deconvolution," *IEEE Transactions on Communications*, vol. 40, pp. 1006–1012, June 1992.
- [75] E. Lohan and M. Renfors, "A novel deconvolution approach for high accuracy LOS estimation in WCDMA environments," in *Proc. of International Symposium on Signal Processing and its Applications, ISSPA'03*, vol. 2, pp. 299–302, July 2003.
- [76] K. Kota, *Parallel algorithms and architectures for subspace-based signal processing*. PhD thesis, ECE Dept., Rice University, Houston, Texas, 1996.
- [77] G. W. Stewart, "An updating algorithm for subspace tracking," *IEEE Transactions on Signal Processing*, vol. 40, pp. 1535–1541, 1992.
- [78] J. Kaiser, "On a simple algorithm to calculate the 'energy' of a signal," in *Proc. of IEEE International Conference on Acoustics, Speech, and Signal Processing*, pp. 381–384, April 1990.
- [79] P. Maragos, J. Kaiser, and T. Quatieri, "On amplitude and frequency demodulation using energy operators," *IEEE Transactions on Signal Processing*, vol. 41, pp. 1532–1550, April 1993.
- [80] R. Hamila and M. Renfors, "Nonlinear operator for multipath channel estimation in GPS receivers," in *Proc. of IEEE International Conference on Electronics, Circuits and Systems*, pp. 352–356, Dec. 2000.
- [81] E. Lohan, R. Hamila, and M. Renfors, "Performance analysis of an efficient multipath delay estimation approach in a CDMA multiuser environment," in *Proc. of IEEE International Symposium on Personal, Indoor and Mobile Radio Communications*, vol. 1, pp. 6–10, Sep. 2001.
- [82] S. Verdu, "Minimum probability of error for asynchronous gaussian multiple-access channels," *IEEE Transactions on Information Theory*, vol. 32, pp. 85–96, Jan. 1986.

- [83] D. Koulakiotis and A. H. Aghvami, "Data detection techniques for DS/CDMA mobile systems: a review," *IEEE Personal Communications*, vol. 7, pp. 24–34, June 2000.
- [84] R. Lupas and S. Verdu, "Near-far resistance of multi-user detectors in asynchronous channels," *IEEE Transactions on Communications*, vol. 38, pp. 496–508, April 1990.
- [85] P. Patel and J. Holtzman, "Analysis of a simple successive interference cancellation scheme in DS/CDMA system," *IEEE Journal on Selected Areas in Communications*, vol. 12, pp. 796–807, June 1994.
- [86] Z. Kostic and S. Seetharaman, "Digital signal processors in cellular radio communications," *IEEE Communications Magazine*, vol. 35, pp. 22–34, Dec. 1997.
- [87] A. Burt, "3G applications challenge chip makers." *EE Times*, p. 112, March 1998. CMP Media Inc., Manhasset, NY, <http://www.eet.com>.
- [88] L. Technologies, ed., *DSP16210 Digital Signal Processor*. LT, Sep. 1997.
- [89] T. I. Incorporated, ed., *User guides for TMS320C6000 DSP platform*. [www.ti.com](http://www.ti.com), 2004.
- [90] E. S. Lohan, A. Lakhzouri, and M. Renfors, "Accurate delay estimation in adverse multipath propagation of galileo and modernized GPS signals." To be submitted to *EURASIP Journal on Applied Signal Processing*, June 2005.
- [91] M. Inc, *SIMULINK Dynamic System Simulation Software*, 1994. User's guide.
- [92] M. Inc., *MATLAB Real-Time Workshop for Use With SIMULINK*, 1994. User's Guide.
- [93] R. W. Johnson, S. Jayaram, L. Sun, and J. Zalewski, "Distributed processing kalman filter for automated vehicle parameter estimation - a case study," in *CD-ROM Proc. of IASTED International Conferences on Applied Simulation and Modeling*, pp. 254–258, 2000.
- [94] Motorola, "Time aligned IPDL positioning technique," 1999. TSGR1 7(99)b79, 3GPP.
- [95] D. Greenwood and L. Hanzo, *Characterization of mobile radio channels*. London, U.K.: Pentech, 1992. in *Mobile Radio Communications*, Edited by R. Steele.
- [96] L. Greenstein, D. Michelson, and V. Erceg, "Moment-method estimation of the Ricean K-factor," *IEEE Communications Letters*, vol. 3, pp. 175–176, June 1999.
- [97] M. Taneda, J. Takada, and K. Araki, "The problem of the fading model selection," *IEICE Transaction on Communucations*, vol. E84-B, pp. 355–358, March 2001.
- [98] A. Papoulis, *Probability, random variables, and stochastic process*. New York: McGraw Hill, 3 ed., 1991.
- [99] A. Sampath and J. M. Holtzman, "Estimation of maximum doppler frequency for handoff decisions," in *Proc. of IEEE Vehicular Technology Conference*, pp. 859–862, May 1993.

- [100] K. D. Anim-Appiah, "On generalized covariance-based velocity estimation," *IEEE Transaction on Vehicular Technology*, vol. 48, pp. 1546–1557, Sep. 1999.
- [101] C. Tepedelenlioglu, A. Abdi, G. B. Giannakis, , and M. Kaveh, "Estimation of doppler spread and signal strength in mobile communications with applications to handoff and adaptive transmission,," *Wireless Communications and Mobile Computing*, vol. 01, pp. 221–242, March 2001.
- [102] T. Klaput and M. Niewiecki, "A novel approach to estimation of doppler frequencies of a time-varying communication channel,," in *Proc. of IEEE American Control Conference*, vol. 4, pp. 3213–3218, May 2002.
- [103] K. Kawabata, T. Nakamura, and E. Fukuda, "Estimating velocity using diversity reception,," in *Proc. of IEEE Vehicular Technology Conference*, vol. 1, pp. 371–374, June 1994.
- [104] T. L. Doumi and J. G. Gardiner, "Use of base station antenna diversity for mobile speed estimation,," *Electronics Letters*, vol. 30, no. 22, pp. 1835–1836, 1994.
- [105] L. Wang, M. Silventoinen, and Z. Honkasalo, "A new algorithm for estimating mobile speed at the TDMA-based cellular system,," in *Proc. of IEEE Vehicular Technology Conference*, pp. 1145–1149, May 1996.
- [106] M. Hellebrandt, R. Mathar, and M. Scheibenbogen, "Estimating position and velocity of mobiles in a cellular radio network,," *IEEE Transaction on Vehicular Technology*, vol. 46, pp. 65–71, 1997.
- [107] M. D. Austin and G. L. Stüber, "Velocity adaptive handoff algorithms for microcellular systems,," *IEEE Transaction on Vehicular Technology*, vol. 43, pp. 549–561, Aug. 1994.
- [108] L. Zhao and J. Mark, "Mobile speed estimation based on average fade slope duration,," *IEEE Transactions on Communications*, vol. 52, pp. 2066–2069, Dec. 2004.
- [109] Y. Suzuki, E. Kudoh, and S. Ogose, "Field test measurement of DS-CDMA RAKE receiver with TWCL in an urban area,," *IEEE Transactions on Vehicular Technology*, vol. 50, pp. 895– 899, July 2001.
- [110] K. Grandell and O. Salonaho, "Macro cell measurements with the nokia WCDMA experimental system,," in *Proc. of IEE International Conference on Antennas and Propagation*, vol. 2, pp. 516–520, April 2001.
- [111] H. Holma and A. Tolli, "Simulated and measured performance of 4-branch uplink reception in WCDMA,," in *Proc. of the IEEE Vehicular Technology Conference (VTC 2001 Spring)*, vol. 4, pp. 2640–2644, May 2001.
- [112] W. Geng, A. Jalali, and P. Mermelstein, "On channel model parameters for microcellular CDMA systems,," *IEEE Transactions on Vehicular Technology*, vol. 44, pp. 706–711, Aug. 1995.

- [113] H. M. El-Sallabi, H. Bertoni, and P. Vainikainen, "Experimental evaluation of RAKE finger life distance for CDMA systems," *Antennas and Wireless Propagation Letters*, vol. 1, no. 2, pp. 50–52, 2002.
- [114] J. Caffery and G. Stuber, "Subscriber location in CDMA cellular networks," *IEEE Transactions on Vehicular Technology*, vol. 47, pp. 406–416, May 1998.
- [115] K. Wuk, G. L. Jang, J. Gyu-In, and K. ByungSoo, "Direct estimation of NLOS propagation delay for mobile station location," *Electronics Letters*, vol. 38, pp. 1056–1057, Aug. 2002.
- [116] G. Hein, J. Godet, J. Issler, J. Martin, T. Pratt, and R. Lucas, "Status of galileo frequency and signal design," in *CD-ROM Proc. of the Insitute of Navigation GPS conference*, Sep. 2002.
- [117] F. Bastide, O. Julien, C. Macabiau, and B. Roturier, "Analysis of L5/E5 acquisition, tracking and data demodulation thresholds," in *Proc. of ION GPS*, pp. 2196–2207, Sep. 2002.
- [118] R. Fontana, W. Cheung, and T. Stansell, "The modernized L2C signal - leaping forward into the 21st century," *GPS World*, pp. 28–34, Sep 2001.
- [119] J. Betz, "The offset carrier modulation for GPS modernization.," in *CD-ROM Proc. of ION Technical meeting*, Jan. 1999.
- [120] J. Betz, "Design and performance of code tracking for the GPS M code signal," tech. rep., MITRE Organization, Sep. 2000. [http://www.mitre.org/support/papers/tech\\_papers99\\_00](http://www.mitre.org/support/papers/tech_papers99_00).
- [121] J. Betz and D. Goldstein, "Candidate designs for an additional civil signal in GPS spectral bands," tech. rep., MITRE Organization, Feb. 2002. Source: [http://www.mitre.org/support/papers/tech\\_papers\\_02](http://www.mitre.org/support/papers/tech_papers_02).
- [122] A. Lakhzouri, E. S. Lohan, and M. Renfors, "Reduced-complexity time-domain correlation for acquisition and tracking of BOC-modulated signals," in *Proc. of the 2nd ESA Workshop on Satellite Navigation User Equipment Technologies*, pp. 623–629, Dec. 2004.
- [123] A. Polydoros and C. Weber, "A unified approach to serial search spread-spectrum code acquisition - parts I and II: A matched-filter receiver," *IEEE Transactions on Communications*, vol. 32, no. 5, pp. 542–560, 1984.
- [124] H. Park, Y. Yang, S. Yoon, S. Lee, J. Roh, and S. Cho, "Performance analysis of the hybrid search code acquisition technique for cellular CDMA systems," in *Proc. of IEEE International Conference on Communications Systems*, vol. 1, pp. 475–479, Nov. 2002.
- [125] B. Kang and I. Lee, "A performance comparison of code acquisition techniques in DS-CDMA system," *Wireless Personal Communications*, vol. 25, pp. 163–176, 2003.



- [126] W. Zhuang, "Noncoherent hybrid parallel PN code acquisition for CDMA mobile communications," *IEEE Transaction on Vehicular Technology*, vol. 45, pp. 643–656, Nov 1996.
- [127] A. Lakhzouri, E. S. Lohan, and M. Renfors, "Hybrid search single and double - DWELL acquisition architectures for GALILEO signal," in *Proc. of the IST Mobile and Wireless Communications Summit*, June 2004.
- [128] E. Lohan, A. Lakhzouri, and M. Renfors, "Selection of the multiple -dwell hybrid-search strategy for the acquisition of GALILEO signals in fading channels," in *Proc. of 15th IEEE Personal and Indoor Mobile Radio Communications*, vol. 4, pp. 2352–2356, Sep. 2004.
- [129] M. Meyer, "Wireless enhanced 911 service - making it reality," tech. rep., Bell Labs Tech, 1996.
- [130] I. Frigyes, B. Molnar, L. Juhasz, I. Papp, Z. Bodnar, J. Berces, F. Som, and A. Kasa, "Theoretical and experimental characterisation of the satellite-to-indoor radio channel," in *Proc. of International Conference on Satellite Systems for Mobile Communications and Navigation*, pp. 47–50, May 1996.
- [131] A. Steingass and A. Lehner, "Measuring the navigation multipath channel - A statistical analysis," in *CD-ROM Proc. ION GPS 2004 Conference*, Sep. 2004.
- [132] A. Lakhzouri, E. S. Lohan, I. Saastamoinen, and M. Renfors, "Measurement and characterization of satellite-to-indoor radio wave propagation channel." To appear in *Proc. of The European Navigation Conference (ENC-GNSS'05)*, July 2005.

# List of Publications

## Publication P1

A. Lakhzouri, E. S. Lohan, R. Hamila and M. Renfors. Solving Closely Spaced Multipaths Via Extended Kalman Filter in WCDMA Downlink Receivers. In *Proc. of IEE European Personal Mobile Communications Conference, EPMCC'03*, Glasgow, UK, March, 2003, pp. 914-919.

Copyright ©2003 IEEE. Reprinted, with permission, from the proceedings of EPMCC 2003.

## Publication P2

A. Lakhzouri, E. S. Lohan and M. Renfors. EKF based LOS estimation with inter-cell interference cancellation for WCDMA Positioning. In *Proc. of IST Mobile and Wireless Communications Summit, IST'03*, Aveiro, Portugal, pp. 206-210.

Copyright ©2003 IST. Reprinted, with permission, from the proceedings of IST Mobile and Wireless Communications Summit 2003.

### Publication P3

A. Lakhzouri, E. S. Lohan and M. Renfors. Estimation of Closely Spaced Paths Via Particle filters for WCDMA Positioning. In *Proc. of IEEE International Symposium on Control Communications, and Signal Processing, ISCCSP'04*, Hammamet, Tunisia, March 2004. pp. 369-373.

Copyright ©2004 IEEE. Reprinted, with permission, from the proceedings of ISCCSP 2004.

## Publication P4

A. Lakhzouri, E. S. Lohan and M. Renfors. On the Programmable Implementation of Particle filters in WCDMA Positioning. In *Proc. of IST Mobile and Wireless Communications Summit, IST'04*, Lyon, France, June. 2004, pp. 248-252.

Copyright ©2004 IST. Reprinted, with permission, from the proceedings of IST Mobile and Wireless Communications Summit 2004.

## Publication P5

A. Lakhzouri, E. S. Lohan and M. Renfors. Constrained Deconvolution approach With Intercell Interference for LOS estimation in WCDMA Positioning. In Proc. of IEEE International Conference on Communications, ICC'04, Paris, France, June.2004, pp. 247-252.

Copyright ©2004 IEEE. Reprinted, with permission, from the proceedings of ICC 2004.

## Publication P6

R. Hamila, A. Lakhzouri, E. S. Lohan, and M. Renfors. A Highly Efficient Generalized Teager-Kaiser-based Technique for LOS estimation in WCDMA Positioning. In *EURASIP Journal on Applied Signal Processing*, Vol. 5, April 2005, pp. 698-708.

Copyright ©2005 Hindawi Publishing Corporation. Reprinted, with permission, from *EURASIP Journal* 2005.



## Publication P7

A. Lakhzouri, E. S. Lohan, R. Hamila and M. Renfors. EKF Channel Estimation for LOS detection in WCDMA Mobile Positioning. In *EURASIP Journal on Applied Signal Processing*, Vol. 13, December, 2003, pp. 1268-1278.

Copyright ©2003 Hindawi Publishing Corporation. Reprinted, with permission, from EURASIP Journal 2003.

## Publication P8

E.S. Lohan, A. Lakhzouri, and M. Renfors. Statistical Properties of Urban WCDMA Channel for Mobile Positioning Applications. Re-submitted after comments to *the International Journal on Wireless & Optical Communications*, (IJWOC); also published as a Technical Report 2-2005, Institute of Communications Engineering, Tampere University of Technology, ISBN 952 – 15 – 1354 – 3.

Tampereen teknillinen yliopisto  
PL 527  
33101 Tampere

Tampere University of Technology  
P.O. Box 527  
FIN-33101 Tampere, Finland