



TAMPEREEN TEKNILLINEN YLIOPISTO
TAMPERE UNIVERSITY OF TECHNOLOGY

Vuokko Heino

**The Effect of Rock Properties on the High Stress Abrasive
Wear Behavior of Steels, Hardmetals and White Cast Irons**



Julkaisu 1575 • Publication 1575

Tampere 2018

Tampereen teknillinen yliopisto. Julkaisu 1575
Tampere University of Technology. Publication 1575

Vuokko Heino

**The Effect of Rock Properties on the High Stress
Abrasive Wear Behavior of Steels, Hardmetals and
White Cast Irons**

Thesis for the degree of Doctor of Science in Technology to be presented with due permission for public examination and criticism in Konetalo Building, Auditorium K1702, at Tampere University of Technology, on the 26th of October 2018, at 12 noon.

Tampereen teknillinen yliopisto - Tampere University of Technology
Tampere 2018

Doctoral candidate: Vuokko Heino, M. Sc
Laboratory of Materials Science
Faculty of Engineering Sciences
Tampere University of Technology
Finland

Supervisor: Veli-Tapani Kuokkala, Dr. Tech., Professor
Laboratory of Materials Science
Faculty of Engineering Sciences
Tampere University of Technology
Finland

Pre-examiners: Riho Tarbe, PhD
Tallinn University of Technology
Estonia

Marcela Petrica, PhD
Engel GmbH
Austria

Opponent: Marcela Petrica, PhD
Engel GmbH
Austria

Urban Wiklund, Dr. Tech, Professor
Department of Engineering Sciences
Uppsala University
Sweden

ISBN 978-952-15-4205-3 (printed)
ISBN 978-952-15-4224-4 (PDF)
ISSN 1459-2045

Abstract

Mining and mineral processing is a challenging field of industry for many reasons, including technological, economical, as well as political aspects. The market prices are constantly changing, many of the mines are located in politically unstable areas, environmental issues are becoming more and more topical, and, of course, technological requirements for the machinery used in various applications are constantly increasing. There are many ways to answer the technological challenges, and materials science is evidently one of the key areas where technological development can and must be expected. As wear of materials is a technological problem that causes huge expenses to the mining and mineral processing industry, it is only natural that this area is being under intense scientific and technological research, a part of which also this doctoral thesis is.

The correct material selection for a certain wear environment will provide not only longer service intervals but also higher productivity, reduced use of energy and lower operating costs, as well as better environmental balance and lower climate impact. Despite the many changes that have taken place in mineral handling over the years, still today the significantly highest fraction of mine products constitutes mineral fuels, ferro-alloys, and other industrial minerals. All these product lines are very different from each other, and therefore the material selection suitable for one type of production may not be applicable to the other ones. Also the location of the production plays a huge role, for example whether it is in sub-tropic or in arctic regions of the globe.

In this work, high stress abrasive wear of several different types of materials was studied using four different natural abrasives, i.e., rocks, and several different test methods. The main aim was to identify such characteristics of the abrasives that affect the most the wear behavior of the studied materials. In the best case, with that kind of knowledge prediction of the material's performance at various mineral handling sites could be done just by knowing the composition of the soil or the bedrock in the area. Although this ultimate goal was not yet reached, some useful features were identified, which together with increased scientific understanding will help to better understand and control the practical wear processes. For example, one of the important findings was related to the embedment of quartzite particles on the surfaces of wearing materials, leading to the formation of mechanically mixed layers and affecting the further wear behavior of the studied materials.

In addition to looking at the wear problems from the abrasive point of view, also the influence of the microstructure of the wearing materials was widely studied in this work. Different features in the microstructures of the studied steels, WC-Co hardmetals, and white cast irons were found to affect the high stress abrasion processes significantly, including the overall (bulk) hardness of the materials, hardness of the different constituents of the microstructure, and the size of the abrasives relative to the microstructural features of the materials.

The producers of engineering materials usually provide the customers with data sheets containing the basic material properties, such as the strength, ductility and hardness values.

However, when used in circumstances where wear is the main mechanism of material deterioration, these values should be considered with caution. This is because the behavior of materials in wear related applications is strongly dependent on the entire tribosystem. In addition, when the materials become into contact for example with rocks, especially under high stresses, these properties may also be changed even quite drastically. These effects were studied in this work with tribometer measurement of differently worn and polished surfaces to see and quantify the differences in their tribological behavior.

Preface

This work was done at Tampere Wear Center of the Laboratory of Materials Science at Tampere University of Technology. Due to the close collaboration with industry, the topic was selected so that it considers practical wear problems from a scientific research point of view. Quite big part of this work was related to the national SHOK research programs, FIMECC DEMAPP and DIMECC BSA. The Finnish Funding Agency for Innovation (Tekes) and the participating companies are therefore gratefully acknowledged for their financial support. The finalizing of this thesis was supported by the Doctoral School of Engineering Sciences at Tampere University of Technology, which is also gratefully acknowledged.

I wish to express my gratitude to my supervisor Professor Veli-Tapani Kuokkala for his guidance, support and valuable comments. I owe tremendous gratitude towards Lic. Tech Kati Valtonen of all her help during the years.

I would like to also express my gratitude towards Dr. Marke Kallio, Lic. Tech Pekka Siitonen and Dr. Päivi Kivikytö-Reponen (nowadays working at VTT) from Metso Minerals for all the co-operation during the years I was working at the Department of Materials Science. I am grateful to all the former and present staff at the Department of Materials Science and my current colleagues at the VTT.

Especially I owe gratitude towards the "old gang" originally from the Tampere Wear Center Dr. Vilma Ratia, Dr. Juuso Terva, Dr. Matti Lindroos and Dr. Niko Ojala. It has been pleasure to work with you all! I have always been very lucky when it comes to my colleagues. Previous at the TUT and nowadays at the VTT, it has been pleasure to work with such talented people with great sense of humor.

Finally, I would like to thank my friends and family for their support and encouragement during these years.

Tampere, October 2018

Vuokko Heino

List of original publications

This thesis is based on the studies presented in detail in the following five publications, referred to as Publications I-V.

- I. Vilma Ratia, Vuokko Heino, Kati Valtonen, Minnamari Vippola, Anu Kemppainen, Pekka Siitonen, Veli-Tapani Kuokkala, Effect of abrasive properties on the high-stress three-body abrasion of steels and hardmetals, *Finnish Journal of Tribology* 32(2014), 3-18.
- II. Vuokko Heino, Päivi Kivikytö-Reponen, Minnamari Vippola, Kati Valtonen, Veli-Tapani Kuokkala, Wear reducing effect of embedded quartz abrasives in the crushing pin-on-disc test method, *Tribology Online* 7(2012), 179-183.
- III. Vuokko Heino, Kati Valtonen, Päivi Kivikytö-Reponen, Pekka Siitonen, Veli-Tapani Kuokkala, Characterization of the effects of embedded quartz layer on wear rates in abrasive wear, *Wear* 308(2013), 174-179.
- IV. Vuokko Heino, Kati Valtonen, Veli-Tapani Kuokkala, Effect of quartzite and granite in wear surfaces on dry sliding, *Tribology – Materials, Surfaces and Interfaces* 8,2 (2014), 85-89.
- V. Vuokko Heino, Marke Kallio, Kati Valtonen, Veli-Tapani Kuokkala, The role of microstructure on the high-stress abrasion of white cast irons, *Wear* 388-389 (2017), 119-125.

Author's contribution

In Publication I, the main author was Vilma Ratia. All the planning, testing, characterization, and writing of the manuscript were done together by Vuokko Heino and Vilma Ratia. In all the other Publications listed above, Vuokko Heino was the main author and responsible for the planning, testing, and characterization of the tests presented in each of the Publications. All manuscripts were commented by all the co-authors.

List of symbols and abbreviations

AC	As-cast (cast-iron)
AC-SH	Self-hardened (cast-iron)
COF	Coefficient of friction
CAI	Cerchar Abrasivity Index
EDS	Energy-dispersive X-ray spectroscopy
EQC	Equivalent Quartz Content
H	Hardened and stress relieved (cast-iron)
HVx	Hardness in Vickers scale, number x indicates the used load in kilograms.
LCPC test	Laboratoire Central des Ponts et Chaussées test for abrasiveness
N	Normalized (cast-iron)
MMC	Metal matrix composite
RAI	Rock Abrasivity Index
SEM	Scanning electron microscope
UCS	Unconfined Compressive Strength
WC-Co	Tungsten carbide in cobalt matrix
wt%	weight percent
XRD	X-ray diffraction
1/min	Revolutions per minute (rpm)

Contents

Preface.....	III
List of original publications.....	V
Author's contribution.....	V
List of symbols and abbreviations.....	VII
1. Introduction.....	1
1.1 Aims and objectives of the study.....	2
1.2 Research questions.....	3
2. Wear mechanisms.....	5
3. High stress abrasion with natural rocks.....	9
4. Materials and Methods.....	13
4.1 Wear test materials.....	13
4.2 Abrasives.....	15
4.3 Crushing pin-on-disc.....	15
4.4 Tribometer.....	16
4.5 Characterization methods.....	17
5. Results and discussion.....	19
5.1 Behavior of the WC-Co and steel specimens in the crushing pin-on-disc tests.....	19
5.2 Effects of embedded quartz on the abrasive wear rates.....	23
5.3 Frictional behavior of worn surfaces.....	26
5.4 High stress abrasion of white cast irons.....	29
6. Conclusions and research questions revisited.....	33
References.....	38
APPENDIX: Original publications.....	43

1. Introduction

Wear and wear related problems have a long history that extends all the way back to the pre-historic times, when the tools used to manufacture various types of stone objects such as vessels, figurines, etc., were already found to suffer from this phenomenon [1]. Today, wear is observed everywhere from everyday life of ordinary people to all branches of industry. On the industry level, the natural incentive to solve wear related problems is money: even a slight increase in the efficiency of production, more optimized spare part change intervals of machinery, and optimally chosen materials for a certain wear environment can bring about huge economical savings to both the manufacturers of the machinery as well as to their customers.

Mineral processing and mining industry are a significant part of the economy worldwide. An important characteristic of these industries is that they consume a lot of energy. For example in 2012, the metal and non-metal mining industry was estimated to consume 150 PJ worth of energy [2]. The main part of this energy is consumed on wear and friction, which provides an excellent motivation for the studies of mining related wear [2, 3]. The value of raw materials is constantly changing based on supply and demand, which means that increasing service life of wear components and the overall efficiency of the mines would be beneficial in such unstable markets. In addition, the demand for the use of secondary raw materials challenges the wear part development into an entirely new level.

It is very important to understand that wear and wear resistance are not material but system properties. This means that the same material can act completely differently when its surroundings or conditions are changed, in some cases even only very slightly. The underestimation of the importance of the tribological interface, commonly referring to the interface between mating solid bodies, has quite often led to false conclusions, as the wear performance may be altered for example by mechanical intermixing, oxidation, or formation of tribofilms after the very first contact [4].

Rock drilling plays an important part in the building of the infrastructures everywhere in the world. It is also used as the basic tool in mines and excavation sites, not to mention its increasing use in geothermal applications. Based on the location, the bedrock or soil can vary hugely, which increases the complexity of the wear phenomena together with the various types of movement patterns employed in the drilling [5–8]. Depending on the rock or soil type and the movement of the drill head (including the amplitude and frequency of the impacts), the right selection of the hard metal grade based on the wear environment can affect the lifetime of the drill bits and the achieved maximum uninterrupted drilling times. Quite many studies on the effects of soil and abrasives on the wear rates have been published recently [9–12], mainly dealing with the tunneling processes and abrasivity of soils. The used abrasive size in these studies, however, has been quite small to have a realistic comparison with the materials used in the mineral processing and mining industry.

In hoisting and hauling of rocks, for example in the mines with loader buckets, most of the wear occurs at the cutting edges of the buckets [13]. The service hours of the machinery, to

which the bucket has been attached, are largely dictated by the lifetime of the cutting edge. When the cutting edge has worn out, the entire machinery is also on hold, and in the worst-case scenario, the whole process is suffering from the change of a single spare part. Therefore, proper understanding of the wear mechanisms in a certain environment plays a huge role in tailoring the materials for example for the cutting edges of loader buckets. With optimized materials selection, the lifetime of the critical components can be extended with a direct effect on the length of the service intervals and, in the end, increasing cost-effectiveness of the process [14].

Besides the mineral processing and mining industry, all the above said applies also to the tunneling processes [11, 15]. In tunnel boring, the change of the cutters needs to be done before the steel framework starts to become worn out. By precise knowledge of the wear caused by different rock species or soil types, it is possible to better estimate the boring time and adequate materials for the cutters can be selected in order to decrease the down time, which will increase the efficiency of the entire boring process.

1.1 Aims and objectives of the study

Different rock types have different properties, and therefore the demand for tailoring the wear components against different rock species is understandable. The complexity of this requirement is increased by the fact that those properties usually vary also within the rock species, although some general guidelines can be considered. On one hand, the aim is to use certain (wear resistant) materials against certain rock types to extend the service life of the components, but also to recognize the combinations that will lead to decreased component life and, in the worst case, to total failures of the machinery.

This study will concentrate on collecting information about the effects of different rock types on heavy abrasive wear, and on providing deeper insight into the rock-type specific wear and its mechanisms. Different properties of the rocks will be used as a basis in the comparison of the wear performance of different (wear resistant) materials in order to identify the properties that affect the abrasive wear the most. In particular, the effects of the mineral content, compressive strength, crushability, abrasiveness, and hardness of the different rock species were studied in this work. In addition, on-going abrasion changes the wear behavior of the wear surfaces, studying of which was another important objective of this thesis. For example, the embedment of quartzite particles in the wear surfaces was studied by comparing quartzite and granite worn surfaces of materials of different types and different initial hardness. The tribological behavior of granite and quartzite abraded wear surfaces were studied also by scratch testing and related measurement of the friction during abrasion.

The flowchart of this thesis is presented in Figure 1, briefly explaining the main content of the publications involved here and how the thesis is structured. Four of the publications are grouped as they all involve the high stress abrasion as the main test method.

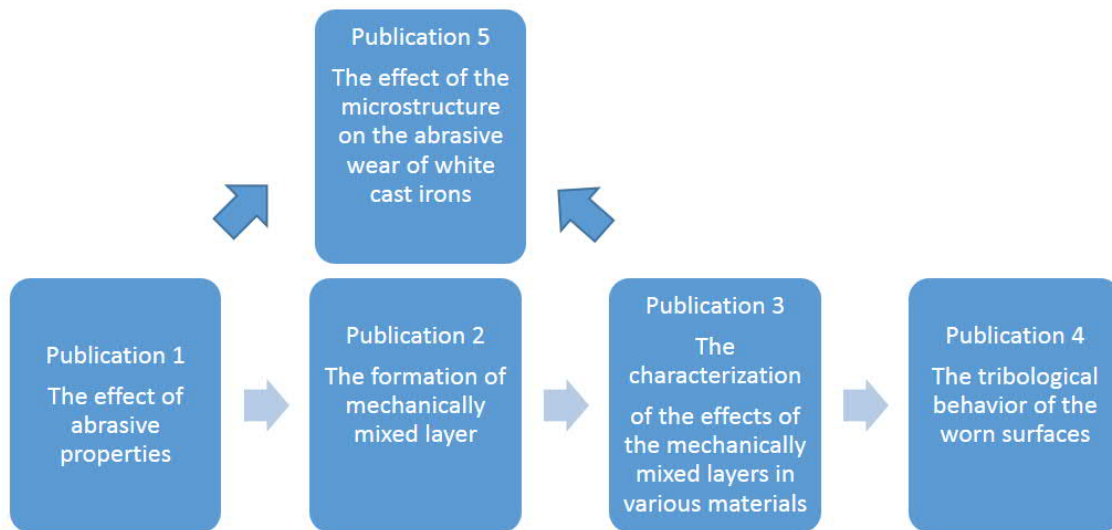

Figure 1. Flow chart of the thesis with included publications.

1.2 Research questions

The research questions of this thesis are as follows:

1. How do the different properties of rocks (minerals) affect the abrasive wear processes, and how should that be taken into account in the selection of materials for different wear-prone processes?
2. How do the in-situ composite layers possibly forming on the wear surfaces affect the wear behavior of steels, cast irons and hardmetals?

The answers to the research questions, as well as the main scientific contributions of this work, will be presented in Chapter 6, Conclusions and research questions revisited.

2. Wear mechanisms

A general and commonly used (simple) description of wear is that it is a phenomenon or mechanism that produces material loss via contact of two surfaces [16–19]. In addition to the presence of the contacting surfaces (normally called the body and the counterbody), this concept includes two other important constituents, i.e., the interfacial environment and the surrounding environment, all these together forming a tribosystem. As mentioned before, wear is considered as a system property rather than a material property, and therefore the outcome of wear can be drastically changed just by changing one of the many variables that can be involved in the process.

The actual way of classifying wear depends strongly on the source or reference and the context where wear is considered. Consequently, there is no standard or universal way to do the classification, and many different approaches can be adapted. Probably the most common but rather crude way is the division to mechanical, thermal, and chemical wear, as shown in Figure 2, which, on the other hand, also reveals the complexity of wear and the multitude of its types or mechanism. It must also be born in mind that rarely only one these types or mechanisms is involved in a practical wear process.

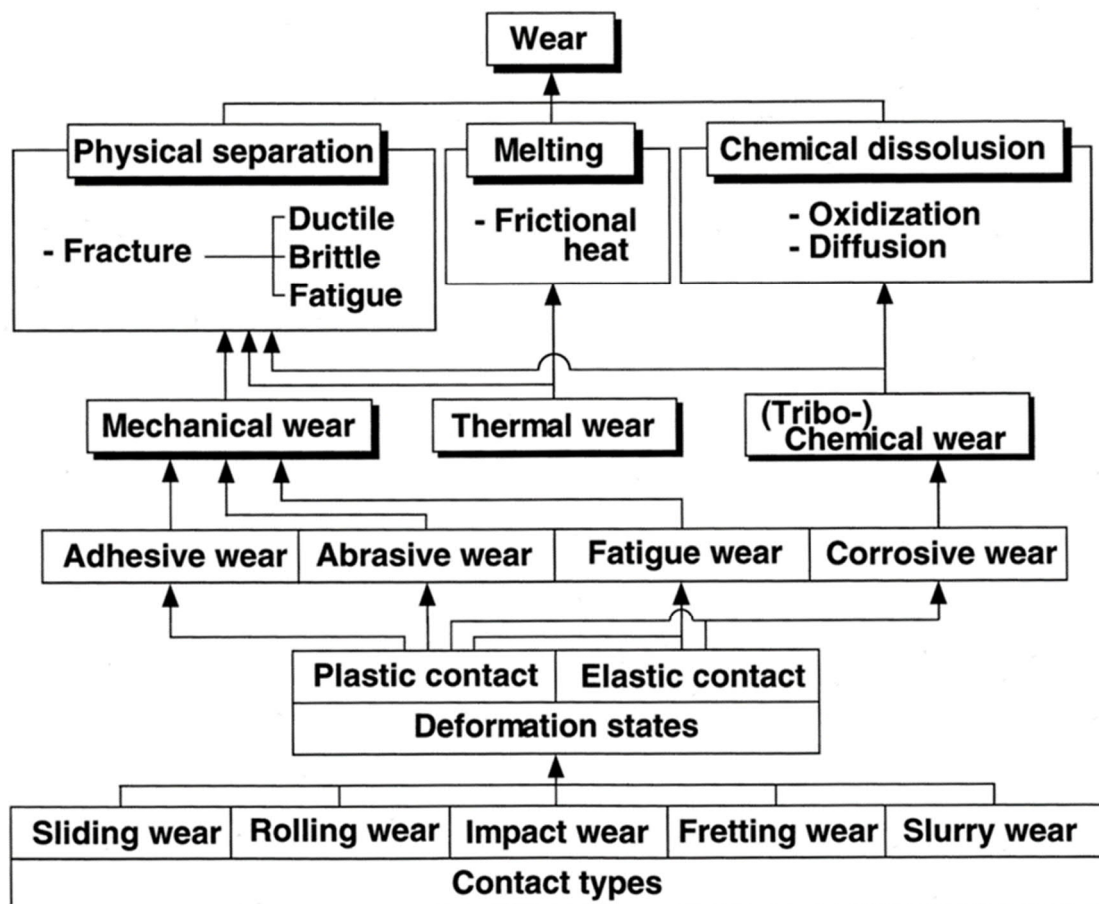

Figure 2. Wear classification according to Modern Tribology Handbook [20].

Of the mechanical wear types indicated in Figure 2, this study concentrates on abrasive wear, and therefore some words of its mechanisms are in order here. A concise definition for abrasive wear is that it is a consequence of hard particles or protuberances forced into a surface and made to move across a solid surface. It can be further classified by the type of the contact or the number of the participating entities into two-body and three-body abrasive wear. In two-body wear, there are abrasive particles or protuberances moving on a solid surface, while in three-body wear there are (loose) abrasive particles between the two solid surfaces. In three-body abrasion, the amount of wear is usually about one to two orders smaller than in the corresponding two-body abrasive wear. In practice, abrasive wear often begins as two-body wear but develops gradually into three-body wear when wear particles are formed, depending on the contact conditions [21,22].

In abrasive wear, the contact environments can also be classified into open or closed environments, which will have an effect on the wear rate of the system. In an open environment, the surfaces are sufficiently displaced and independent of one another, and therefore the abrasives are not directly forced into the solid surface. A closed contact environment is more constrained, and the abrasive particles are forced to make contact with the solid surface, thus generally resulting in higher wear rates. Figure 3 shows some examples of the above-mentioned types of abrasive wear [22].

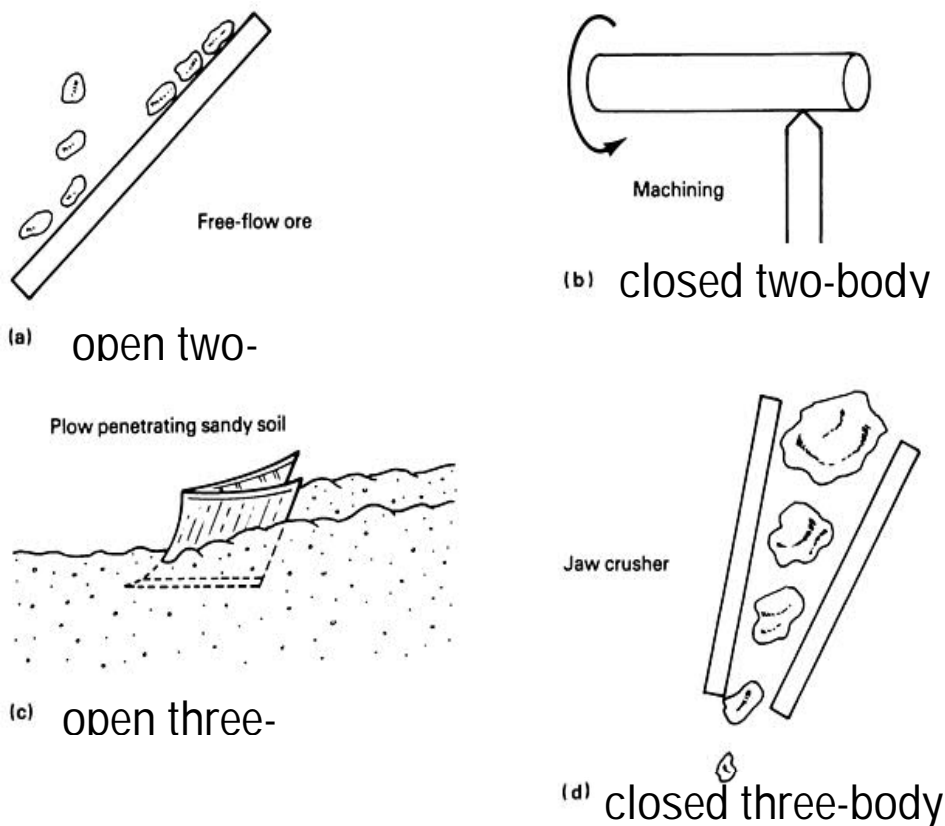

Figure 3. Abrasive wear classifications; a) open two-body, b) closed two-body, c) open three-body, and d) closed three-body [22].

Identification of the wear environment based for example on the classifications presented in Figure 3 helps to make some initial estimates and assumptions about the actual wear mechanisms and expected wear rates, and it at least to some extent also facilitates the materials selection process. In abrasive wear, the generally identified wear mechanisms are cutting, ploughing, fatigue, brittle fracture, and carbide pull-out [23,24]. There are also other terms in use for describing the abrasive wear mechanisms, but in this thesis, we will be focusing on these five only. A schematic presentation of the abrasive wear mechanisms is presented in Figure 4.

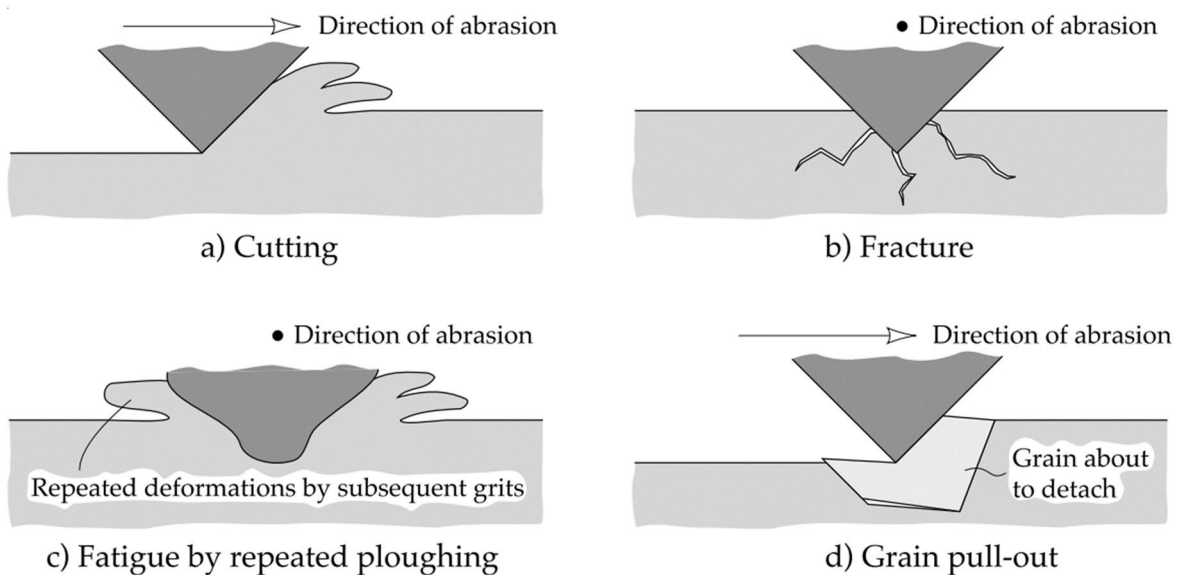

Figure 4. Abrasive wear mechanisms according to Engineering Tribology [25].

For ductile materials, the highest material loss is usually produced by cutting. In pure ploughing, instead, no material is lost from the surface but it is only pushed aside of the forming groove. Figure 5 presents a schematic cross-section of the wear scar in a ductile material. In pure ploughing, the area A_1+A_2 pushed aside is equal to the area A_v of the wear scar, while pure cutting means that $A_1+A_2 = 0$ and $A_v > 0$ [24]. Oftentimes these two mechanisms coincide and their relative contributions can be calculated from the areas shown in Figure 5. The ratio between ploughing and cutting depends for example on the material and the attack angle of the abrasives. Higher wear rates normally occur when the cutting mechanism dominates the wear process [19]. Generally speaking, these two wear mechanisms lead to rather uniform and predictable wear behavior (if the process parameters remain the same), and therefore the lifetime of wear-prone parts or components can be quite well predicted. In addition, (micro)fatigue can be observed on the wear surfaces of ductile materials due to ploughing of the same area multiple times, resulting in material loss as flakes

due to low cycle fatigue. This form of wear cannot be so easily controlled nor the lifetime of the component predicted, as compared to the ploughing or cutting types of wear [16,23].

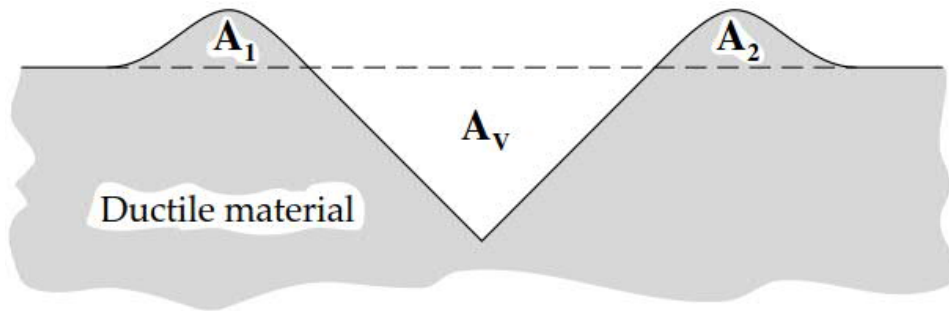

Figure 5. Schematic presentation of the cross-section of a wear scar in a ductile material [26].

In brittle materials, wear is mainly occurring by brittle fracture caused by localized high stresses. This is generally a highly undesired form of wear since it often occurs suddenly and may produce rather large fragments with sometimes even catastrophic consequences. The wear resistance of a material can be improved by mixing hard phases/particles with a softer matrix, such as in the cases of metal matrix composites, cast irons, or hardmetals. Quite often these hard phases are different types of carbides which, on the other hand, can also suffer from brittle cracking and/or pull-outs from the matrix, thus increasing the wear rate of the material [23,25].

3. High stress abrasion with natural rocks

Different rock species are composed of different minerals, and there are also relatively wide local variations within the (nominally) same rocks. Each rock consists of at least one mineral, but usually a rock contains several different minerals. Figure 6 clarifies the composition of the rocks. Therefore, it is usually not possible to compare the wear environments based only on the name and general (average) properties of the prevalent rock species. Granite, for example, is found at many locations worldwide, and consequently its properties vary accordingly. This variation is mainly caused by the initial formation process of the bedrock, typically millions of years ago.

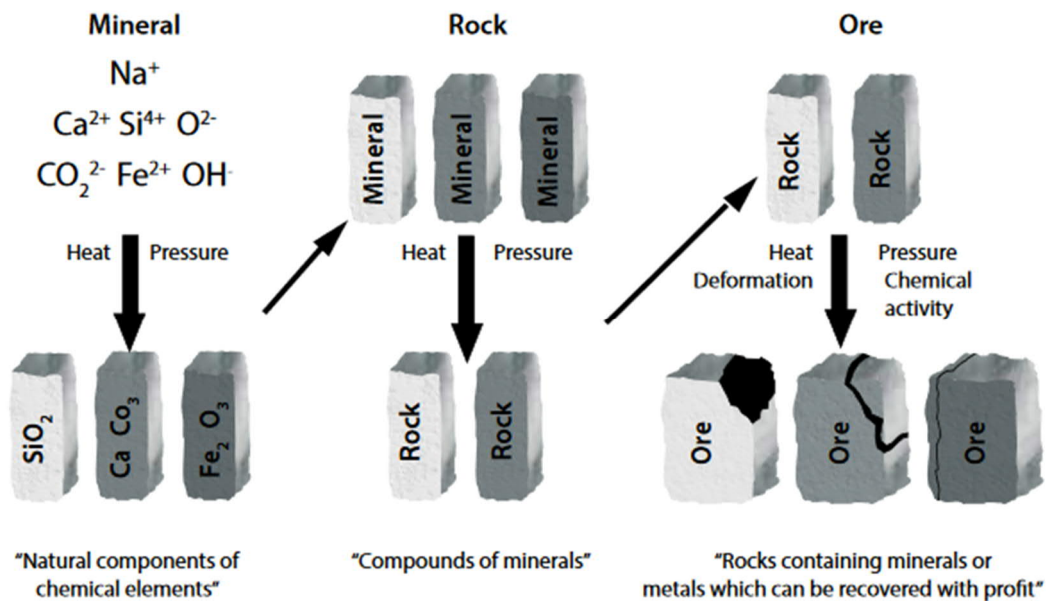

Figure 6. The formation and composition of rocks [27].

When observed at the microscopic level, high-stress abrasion involves material removal by a combination of cutting, plastic deformation, and surface fracturing. On the macroscopic level, we would typically observe tearing and fatigue, leading to the spalling of the material [16]. The principal difference between the high-stress abrasion and low-stress abrasion is that in the latter, the abrasive particles are not fractured during the process [28].

In abrasive wear, the particles involved in the process play a huge role. Their hardness and especially their hardness difference with the wearing materials are in a key role [29]. Figure 7 presents the general effect of the hardness ratio between the wearing material and the used abrasives, indicating that the limit where the wear rate is suddenly decreased, i.e., the wear resistance is increased, is at around 0.8. Other important parameters related to the particles are their shape and size. There are many different ways to take into account the shape of the particles, as presented for example by Stachowiak et al. [30–36], who studied the effects of

the asperity sharpness and shape of the particles by simulations and experimental techniques.

In the case of high-stress abrasion, the original shape of the particles has been found to be rather irrelevant if the fracture rate of the particles is high enough [37]. On the other hand, in low stress abrasion the original shape of the abrasive particles has normally a quite large role [20]. The size effect depends also on the microstructure of the wearing material. In homogenous materials, a large abrasive size generally leads to higher wear rates, while in materials with a heterogeneous microstructure (such as the WC-Co hardmetals), the wear rate tends to be higher with smaller size particles that can attack the binder phase or the matrix more easily [38,39]. However, these effects are not so straightforward and easy to predict, as many parameters with sometimes contradicting effects work together. For example, in the case of heterogeneous microstructures we might find that large particles are producing very high stresses that may exceed the fracture strength of the carbide phase. This will cause cracking of the carbides, which significantly increases the wear rates.

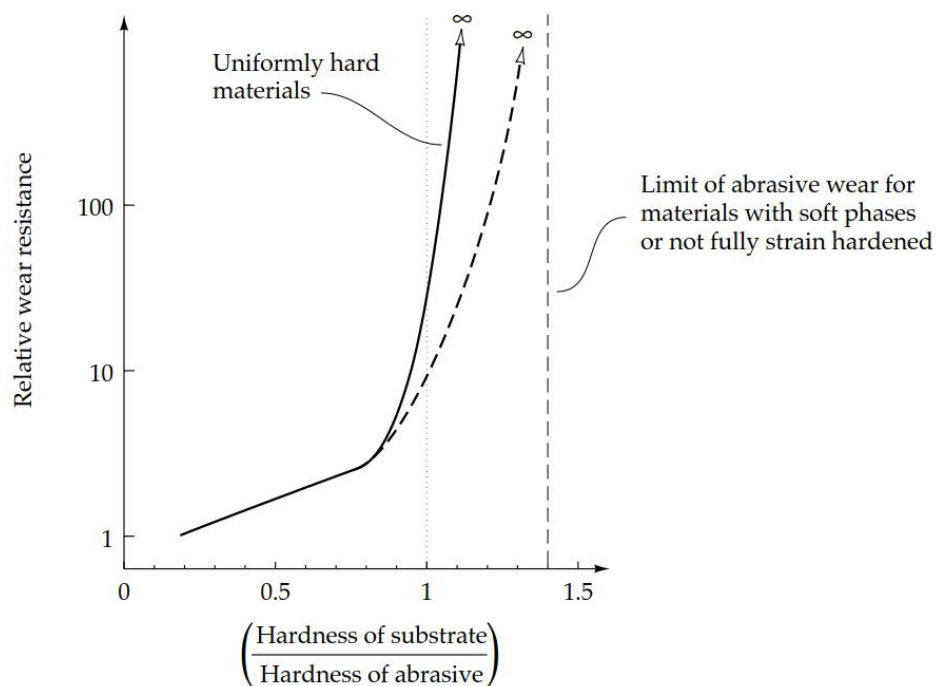

Figure 7. Relative abrasive wear resistance versus hardness ratio of the wearing material (substrate) and the abrasive [26].

Quite many studies in the field of high stress abrasion use natural rocks as abrasives [6,40–42]. According to Gupta et al. [41], the main abrasive parameters affecting the wear rate of WC-Co are the rock abrasivity index (RAI), and abrasiveness of the rock. They also suggested that the best correlation between the rock properties and the drill life is obtained by plotting

the drill bit lifetime against the rock abrasivity index, which is the uniaxial compressive strength of the rock multiplied by the equivalent quartz content of the rock.

Another general observation is that the number of published papers related to rubber wheel abrasion testing is very high. This is a standardized test method, which is also highly criticized. The test as such is actually a rather good way to study and compare the wear of different materials, but its worst shortcoming is that the wear conditions it creates do not widely exist in real applications [13,43–49]. Albertin et al. [50] criticized the use of quartz as a standard abrasive, unless the actual application also involves a quartz-rich environment. In the studies of Albertin et al. [36], hematite and phosphate rocks as abrasives gave the expected results of decreasing wear rate with increased carbide fraction, while the result obtained with quartz was exactly the opposite. According to them, the reason was that the removal of the matrix phase was more sudden in the cases where the carbide fraction was higher, making the remaining carbide phase more vulnerable to the high contact stresses and favoring carbide cracking as the main wear mechanism. This case has similarities with the abrasive wear of WC-Co materials [5,7,8,51,52], where the soft binder is removed easily and the carbide fraction is high enough for the skeleton to suffer brittle fracture. However, it might also happen that at a lower fraction of carbides the matrix material is actually mechanically mixed with quartzite particles and therefore the wear rate remains low, as will be shown in Publication III.

There are many different ways to characterize and classify the rocks based on different properties. For example, the Cerchar Abrasivity Index (CAI) describes the abrasivity of the rock based on the measured diameter of the wear flat formed on the standard size initially sharp pin when it is moved 10 mm under a static load of 70 N across the rock surface [12, 53]. The Rock Abrasivity Index (RAI), in turn, is obtained by multiplying the rock's Unconfined Compressive Strength (UCS) by its Equivalent Quartz Content (EQC), thus taking into account the two core parameters relevant for abrasive wear [54]. Abrasiveness, on the other hand, is defined as the amount of material removed from a standard specimen when one ton of rock is passed over it (the resulting unit is g/t). This value is based on the French standard NF P-18-579 "Abrasive and crushability test" (Essai d'abrasivité et de broyabilité) [55]. The test involves a standard steel test plate, which is rotated in a bowl at 4500 1/min for 5 minutes together with 500 g of 4-6.3 mm rock particles. The mass loss from the steel plate is measured and divided by the mass of the rock particles. The same standard also defines the crushability of the rocks, which is received simultaneously with the abrasiveness values from the same test: the crushed rocks are sieved and the crushability is the percentage of the rocks with a size less than 1.6 mm. This means that the higher the crushability number, the easier the rock is being crushed.

4. Materials and Methods

This chapter introduces all the test materials and test methods used in this study. Several materials from different material groups were tested using a wide variety of wear testing devices and techniques. However, the main interest was on the abrasive wear behavior of the chosen materials.

4.1 Wear test materials

In this work, the main test materials were WC-Co hardmetals, various steels, cast irons (CI, WCI), and metal matrix composites (MMC). The WC-Co hardmetals were selected so that they had enough ductility to avoid brittle fracturing of the tungsten carbides during high stress abrasion. The average carbide size in all studied hardmetals was 2.5 μm . The tested steels were a structural steel, several different wear resistant steels, and a tool steel. The cast irons were all high-chromium white cast irons, and the metal matrix composite contained recycled and crushed WC-Co hardmetals in a tool steel matrix. All the test materials used in this study are presented in Table 1.

Table1. Hardness and nominal composition of the test materials and their use in the attached publications.

Material	Code	Hardness (HV)	Nominal composition	Publication
Cast iron	CI	580HV10	3% C, 28% Cr	III, IV
Cast iron	AC	350HV10	2.9% C, 0.82% Si, 0.8% Mn, 28.2% Cr, 0.62% Ni, 0.15%Mo (as cast, slow cooling rate)	V
Cast iron	AC SH	720HV10	2.94% C, 0.94% Si, 0.7% Mn, 27.1% Cr, 0.71% Ni, 0.61%Mo (as cast, fast cooling rate)	V
Cast iron	H	740HV10	2.94% C, 0.94% Si, 0.7% Mn, 27.1% Cr, 0.71% Ni, 0.61%Mo (hardened and stress relieved)	V
Cast iron	N	718HV10	2.94% C, 0.94% Si, 0.7% Mn, 27.1% Cr, 0.71% Ni, 0.61%Mo (normalized)	V
Hardmetal	WC-Co	1210HV10	WC in 15% Co-matrix	III, IV
Hardmetal	WC-26Co	870HV10	74 wt% WC, 26 wt% Co	I
Hardmetal	WC-20Co	1050HV10	80 wt% WC, 20 wt% Co	I
Hardmetal	WC-15Co	1260HV10	85 wt% WC, 15 wt% Co	I
Metal matrix composite	MMC	800HV10	Recycled and crushed WC-Co (~25 vol%) in the tool steel matrix (1.8% C, 5.25% Cr, 9% V)	III
Structural steel	S355	190HV10	0.18% C, 0.5% Si, 1.6% Mn	III
Structural steel	S355	172HV10	0.18% C, 0.5% Si, 1.6% Mn	I
Tool steel	TS	720HV10	2.9% C, 5.25% Cr, 11.5% V	III, IV
Wear resistant steel	WR2	480HV10	0.29% C, 0.7% Si, 1.6% Mn, 1.5% Cr, 1.5% Ni, 0.6% Mo	II, III
Wear resistant steel	WR1	360HV10	0.14% C, 0.7% Si, 1.6% Mn, 0.5% Cr, 0.25% Ni, 0.25% Mo	III, IV
Wear resistant steel	400HB	423HV10	0.23% C, 0.8% Si, 1.7% Mn, 1.5% Cr, 1.0% Ni, 0.5% Mo	I
Wear resistant steel	500HB	505HV10	0.3% C, 0.8% Si, 1.7% Mn, 1.5% Cr, 1.0% Ni, 0.5% Mo	I

4.2 Abrasives

Table 2 summarizes the key properties of the abrasive materials used in this thesis. The quarry location indicated in the Table is also an essential piece of information, as the rock properties can vary quite much from location to location (and even within the same location). The density and uniaxial compressive strength values were given by the rock producers (quarry owners). The hardness of the rocks were measured from the different mineral phases and correlated by the amounts of each phase present in the rock. The mineral compositions were verified with XRD measurements. The abrasiveness and crushability values were received from the Metso Minerals Rock laboratory, where they were determined using the LCPC test (French standard NFP18-579). All listed abrasives were used in Publication I, granite and quartzite were used in Publications II-IV, and only granite was used in Publication V.

Table 2. Abrasive properties and nominal mineral compositions of the studied abrasives.

	Granite	Quartzite	Tonalite	Gneiss
Quarry	Sorila	Haluna (Nilsjä)	Koskenkylä	Lakalaiva
Density (kg/m ³)	2674	2600	2660	2747
Uniaxial compressive strength (MPa)	194	90	308	64
Hardness (HV1)	800	1200	960	700
Abrasiveness (g/t)	1920	1840	1460	1430
Crushability (%)	34	74	18	37
Nominal minerals (%)	plagioclase (45), quartz (25), orthoclase (13), biotite (10), amphibole (5)	quartz (98), sericite, hematite	quartz (40), plagioclase (40), biotite (17), amphibole (3)	plagioclase (36), biotite (25), quartz (24), orthoclase (7), amphibole (5), garnet (3)
Publication	I, II, III, IV, V	I, II, III, IV	I	I

4.3 Crushing pin-on-disc

The most used test device in this study was the crushing pin-on-disc (Publications I, II, III and V), which has been designed for the studies of high stress abrasion in a laboratory scale. It is based on the common pin-on-disc principle with the addition of loose abrasive particles and a cyclic crushing stage [11]. Figure 8 presents the construction of the test device. The pin (specimen) has a diameter of 36 mm and height of 35 mm. The disc (160 mm in diameter) used in the current tests was made of a structural steel (200 HV5). The disc rotates at 28

1/min, and the pin is cyclically pressed with a 240 N force towards the disc. The disc and the pin do not come into a direct contact with each other due to the layer of abrasives being crushed between them. The crushing cycle consists of two phases. The pin crushes abrasives for 5 seconds (ca. two rotations), after which the pin is lifted up for 2.5 seconds, and then pressed again down to the pile of abrasives for a new cycle. This cycle ensures that there is always a sufficient amount of abrasives between the pin and the disc.

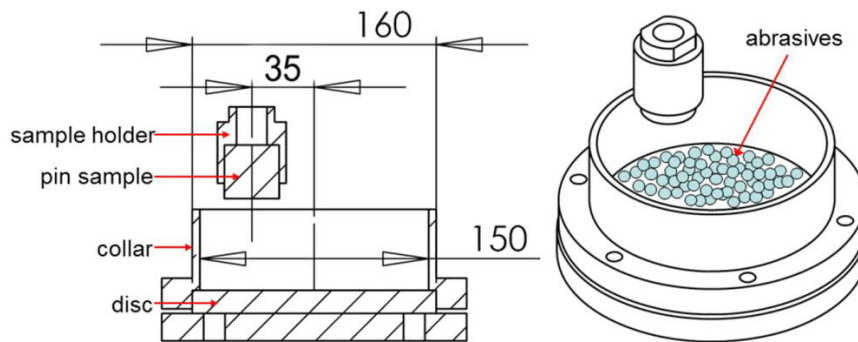

Figure 8. Schematic illustration of the crushing pin-on-disc test device [Publication I].

Before any actual tests took place with the crushing pin-on-disc device, the specimens were subjected to a running-in period with the same device. The length of the running-in period was 15 minutes, and its purpose was to ensure that in the actual wear test the wear surface was already at the steady wear rate region. The actual test took 30 minutes, excluding the time taken by weighting every 7.5 minutes, so that the total effective contact time between the sample and the abrasives was 20 minutes per specimen. The size distribution of the abrasives used in the tests was as shown in Table 3. After the tests, the final size distributions were obtained by sieving the used abrasives.

Table 3. The original size distribution used in the crushing pin-on-disc tests.

Abrasive size (mm)	Mass (g)
8-10	50
6.3-8	150
4-6.3	250
2-4	50
Total	500

4.4 Tribometer

CETR UMT-2 tribometer was used as a scratch tester in Publication IV. A schematic illustration of the test device is shown in Figure 9. The scratch tests were conducted for granite-tested

and quartzite-tested wear surfaces and for polished unworn surfaces. A Rockwell C diamond indenter and a WC-Co hardmetal drill bit insert were used as scratching tips. The Rockwell indenter is a conical stylus with a tip radius of 200 μm , while the spherical WC-Co indenter, later referred to as a WC-Co 'ball', has a radius of 4000 μm . The geometry of mineral abrasives is somewhere between these two indenters. The rotational speed of the tribometer was kept at a constant low value of 0.2 1/min to minimize the frictional heating of the specimens. The constant loads of 50 N and 100 N were used in the sliding or scratching circular track tests of one full rotation. The friction was determined from the ratio between the (tangential) force restricting the movement of the tip and the applied normal force, obtained from the two-dimensional force sensor of the tribometer.

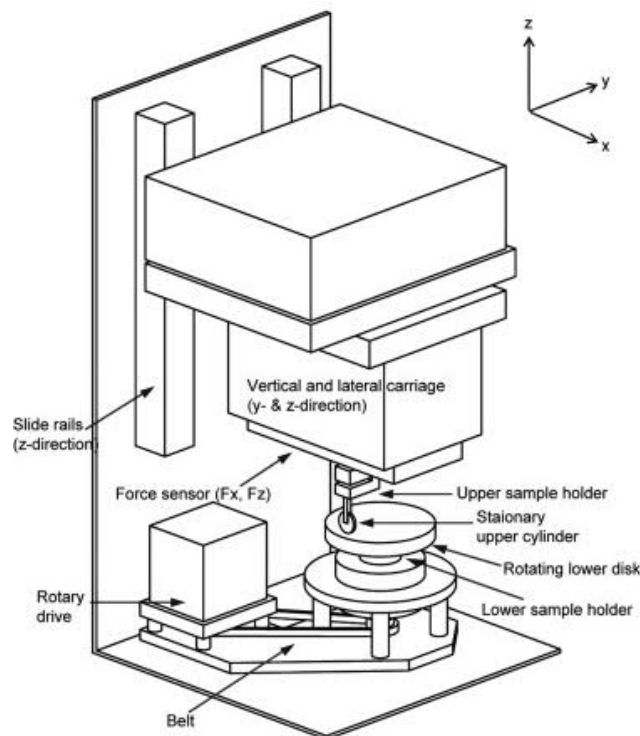

Figure 9. The principle of CETR UMT-2 as a schematic illustration [56].

4.5 Characterization methods

All wear surfaces were studied with scanning electron microscopy (Philips XL-30) using both secondary and back-scattered electron detectors. Specimens demanding better resolution were also studied with a field emission gun FEG-SEM (Zeiss UltraPlus) using both the secondary and back-scattered electrons. The microstructural studies of all materials were conducted using optical and scanning electron microscopy.

The mineral compositions of the rocks as well as the microstructural components of the white cast irons (WCI) were verified by X-ray diffraction (XRD, Panalytical Empyrean) and energy dispersive X-ray analysis (EDS, EDAX D7).

The hardness measurements were done in the macroscale with Struers Duramin A-300 hardness tester. The micro hardness values were obtained with a SEM-integrated Anton Paar micro hardness tester and with a Matsuzawa MMT-X7 micro hardness tester. For wear surface roughness measurements, Alicona Infinite Focus G5 3D and Veeco Wyko NT1100 optical profilometers were used.

5. Results and discussion

This chapter will concentrate on presenting the key findings of the attached Publications I-V. The presentation starts with an overall comparison between the steels and the WC-Co hardmetals tested with different types of rocks, then concentrating more on the differences between the tests conducted with granite and quartzite. After that, the formation and properties of the mechanically mixed layers on the wear surface, as well as their further effects on the proceeding of the wear processes, will be discussed. The tribological behavior of the worn surfaces is studied with friction measurements to better understand the factors that affect the abrasion process. Finally, the relative size effect between the reinforcing components and the particles producing high stress abrasive wear in white cast irons is discussed and explained through the bulk and micro hardness measurements. Overall, the primary focus in this thesis is on the effects of rocks on the abrasive wear processes.

5.1 Behavior of the WC-Co and steel specimens in the crushing pin-on-disc tests

Figure 10 presents the results from the studies (Publication I), where WC-Co hardmetals of different compositions (WC-15Co, WC-20Co, WC-26Co) and three selected steels were compared using the crushing pin-on-disc tests with four different abrasives. The steels used in these studies included a structural steel (S355) and two wear resistant steels (WR1, WR2). The results are presented as volume losses against hardness values. The reason for using volume losses in the comparison is that the WC-Co hardmetals and steels have markedly different densities, and therefore the use of volume losses instead of mass losses leads to a much more realistic comparison. The common observation that the higher the hardness, the lower the wear rate holds also here [16,18]. It should, however, be noted that the WC-Co hardmetals and the studied steels have a fundamentally different microstructure: the microstructure of the steels is, at least in the meso-scale, more or less homogeneous, while the microstructure of the WC-Co hardmetals consists of a hard carbide skeleton surrounded by a soft cobalt-base binder phase. In general, the hardness of the hardmetals can be changed by changing the relative fractions of the carbides and the binder phase. This also means that the ductility of hardmetals decreases with increasing hardness, i.e., with decreasing amount of the binder phase, and in the case of high stress abrasion, this leads to increased wear rates with increasing propensity to brittle fracture. Brittle fracture is somewhat difficult to accurately predict and account for, and therefore it is essential to find an optimum composition for each use case, which is hard enough to limit wear to a desired level but still to keep the material ductile enough to handle for example edge stresses or impacts without fracturing [7]. It should be noted that in the crushing pin-on-disc method the test samples are prone to excessive wear of the edges, as shown by Terva et al. [57].

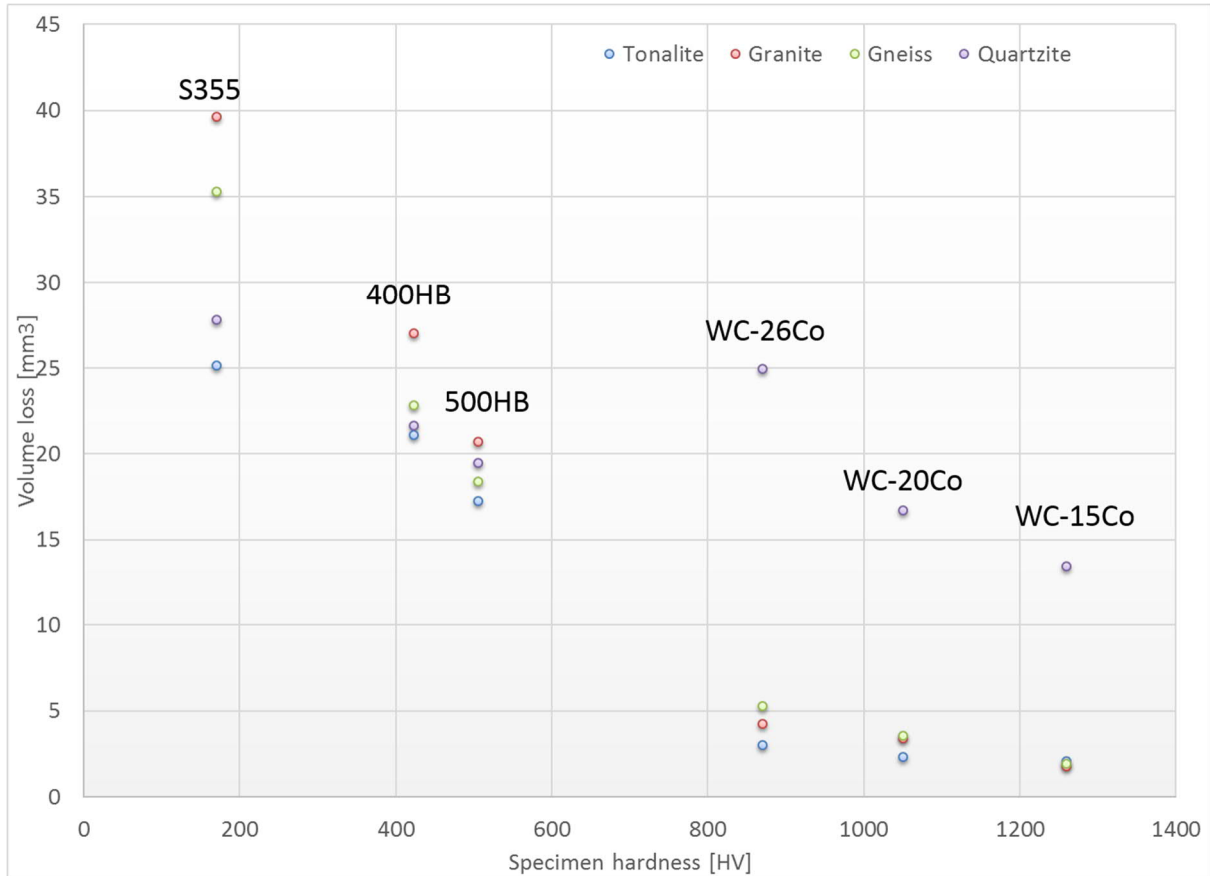

Figure 10. Crushing pin-on-disc results plotted against the hardness of the tested material.

Table 4 presents the standard deviations of the results shown in Figure 10. The deviation is higher in the tests with rocks of higher compressive strength and for hard materials, which might indicate that the wear rates measured for higher hardness materials are more sensitive to brittle fracture, as even small changes in the mass losses lead to higher percentile standard deviations.

Table 4. Standard deviations of the crushing pin-on-disc test results (st.dev%).

Code	GR	GN	T	Q
S355	14.94	6.16	15.64	9.52
400HB	5.47	9.43	23.79	9.81
500HB	8.03	4.19	27.32	8.02
WC-26Co	4.82	8.95	2.22	10.30
WC-20Co	28.58	6.01	10.07	8.43
WC-15Co	21.65	16.37	27.71	6.19

In this work, the abrasives were categorized mainly according to their abrasiveness and crushability values obtained using the LCPC test. The crushability value describes how easily the abrasive is crushed, and therefore it is linked more or less directly to the compressive strength of the rock (gneiss, however, is an exception and the reasons for this will be discussed later on): the higher the number, the more easily the abrasive is crushed to a smaller size. The highest crushability value was obtained for quartzite and the lowest value

for tonalite. The validation of the results of the crushing pin-on-disc tests, or rather the validation of an individual test, can be made by comparing the final size distribution of the used abrasive after the test to the original one: the resulting comminution should be the same when similar rocks are used in the tests. Based on the sieving results, the (relative) comminution of the different types of abrasives used in this work followed closely the results obtained from the LCPC tests. In the case of tonalite, only 12 % of the original 2-10 mm abrasives had been comminuted to the size less than 2 mm, whereas for quartzite the corresponding fraction was as high as 88 %. Granite and gneiss behaved in the tests quite similarly, containing 55-60% of abrasives under 2 mm in size in the final distribution. The results are presented graphically in Figure 11.

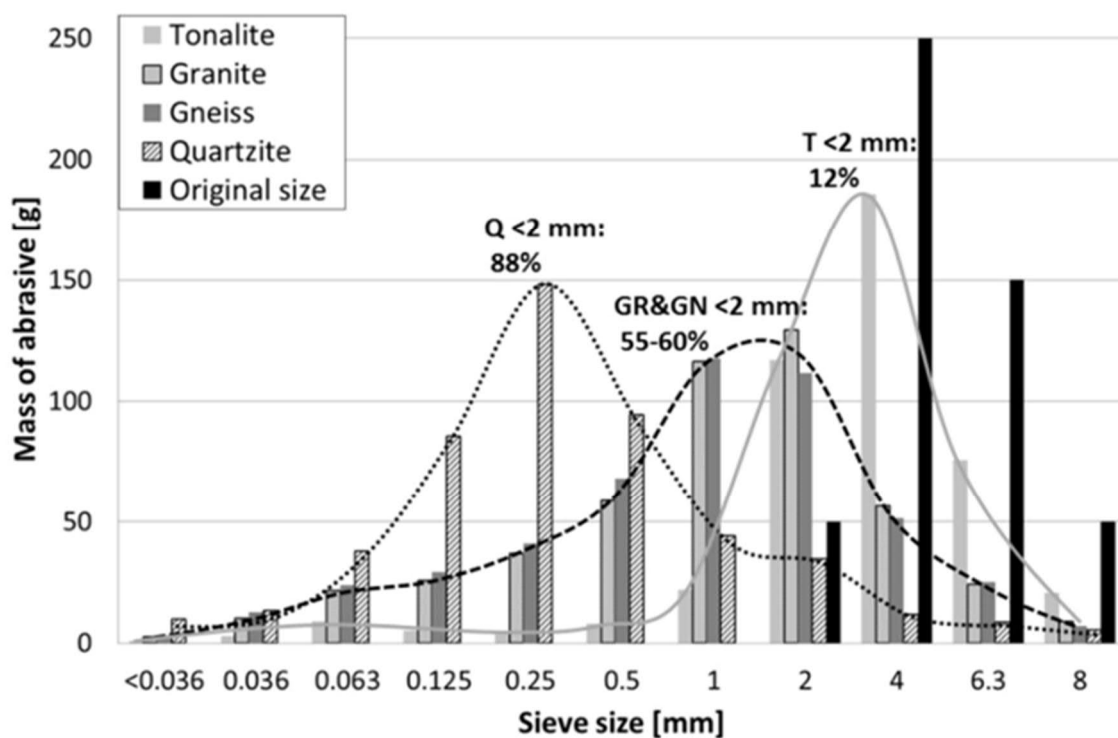

Figure 11. The characteristic sieving results from each tested abrasives. Black bars correspond to the original size distribution of the abrasives before the test [Publication I].

When comparing the data in Figure 12 to the crushability values of the test abrasives, it can be observed that the values are in a similar order as in the LCPC tests. The notations T, GR, GN, and Q in Figure 12 refer to tonalite, granite, gneiss and quartzite, respectively.

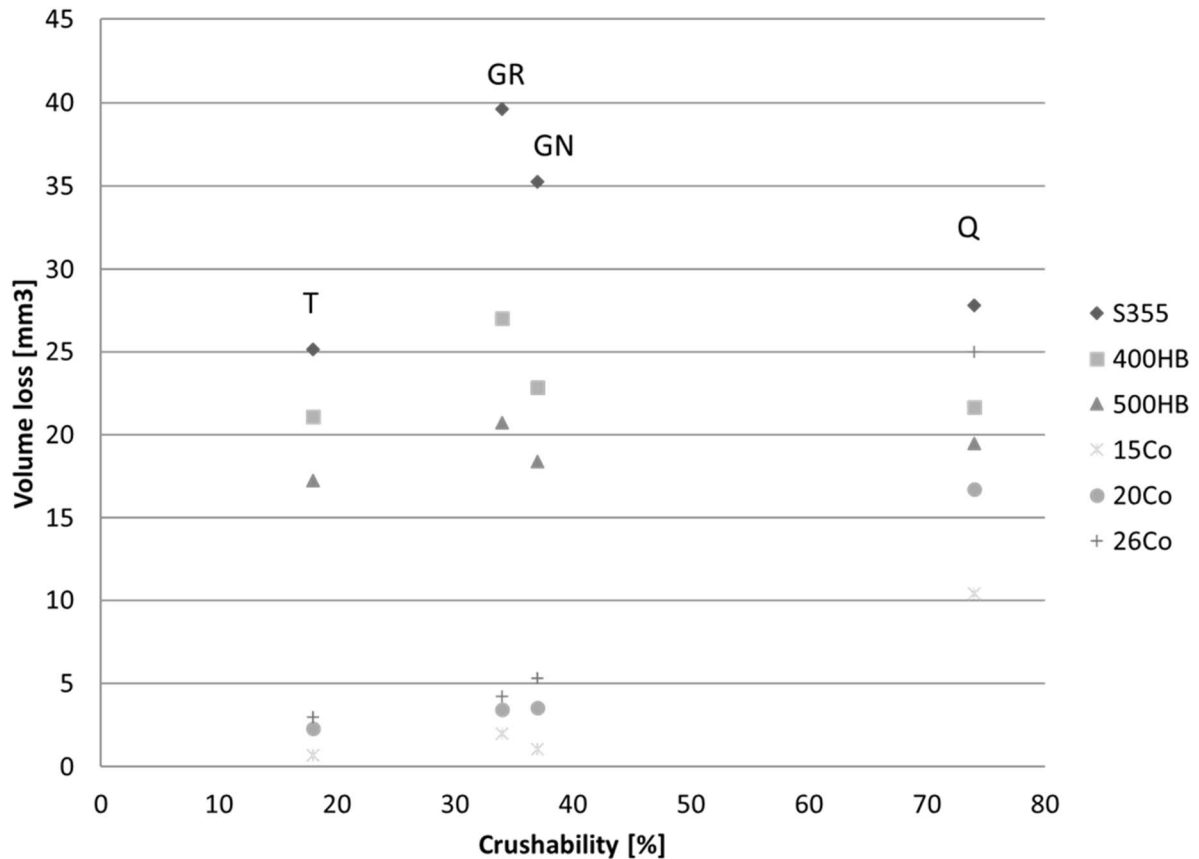

Figure 12. Crushing pin-on-disc results according to the crushability of the rock.

The results for the steels in Figure 12 show that granite is causing the highest volume loss of all the tested abrasives. This is evidently due to the high compressive strength of granite, which means that in high stress abrasion conditions the particles can withstand high stresses without breaking, also causing more cutting to the specimen surface. The cutting marks on the surface of the steels are also longer compared to the lower compressive strength abrasives, which also is an indication of the better stress tolerance of granite. With quartzite, which has a relatively low compressive strength and high crushability, the wear rates are much lower than with granite. An obvious explanation for this is that quartzite is quite easily crushed into fine particles, which are then too small to individually cut the surface of steels. In addition, in the case of quartzite, the pressure distribution caused by the fine particles is more uniform rather than composing of a fewer high stress contact points, as in the case of granite [58]. On the other hand, tonalite with the lowest crushability values is causing the lowest wear rates in the steels, which might be seen to somewhat contradict with the results obtained with granite and quartzite. This, however, might be explained by the notion that if the crushability becomes (by far) too low, not enough fresh cutting surfaces are produced to replace the gradually dulling abrasive particles. Figure 13 shows schematically the sharpening and dulling of the abrasive particles during the abrasion process.

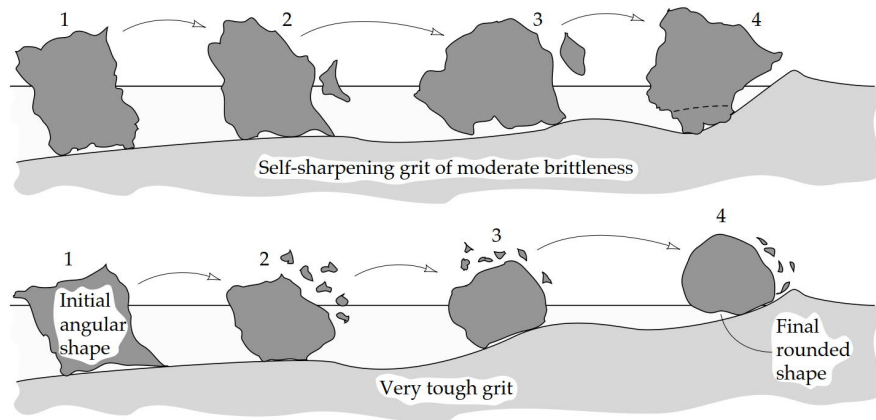

Figure 13. Effect of the abrasive brittleness and ductility on its efficiency to abrade [26].

The role of crushability in the wear behavior of hardmetals is quite different from that observed for the martensitic steels, i.e., the higher the crushability, the higher the wear rate tends to be. For example, quartzite with the highest crushability values is now causing clearly the highest wear rates in the hardmetals. The evident explanation for this is that in WC-Co materials the fine abrasive particles can penetrate between the carbides and wear out the soft binder phase, exposing the carbide skeleton and gradually also leading to the detachment of the carbides.

5.2 Effects of embedded quartz on the abrasive wear rates

Because steels and hardmetals behaved differently when abraded with quartzite and granite, the behavior of wear resistant steel WR2 was further studied in Publication II. The steel was tested in two separate rounds, in the first round either with granite or quartzite, and in the second round, only with granite. The results of these tests showed that the composite layer formed in the first round tests by quartzite on the steel surface decreased the wear rate of the steels in the second round tests with granite. The possible work-hardening effects were also accounted for by measuring the hardness profiles from the cross-sections. The results showed that the hardening behavior was similar in both cases, but the initially quartzite tested samples had a thin harder layer on the very top of the surface, which was further analyzed with EDS. The improvement in the wear resistance was ca. 20% compared to the same steel initially abraded with granite. In the tests with quartzite, a composite layer of mechanically mixed steel and quartzite was formed on the wear surface of the specimens. The wear surfaces of the samples with a quartzite composite layer were smoother than the samples that had been originally tested with granite. The EDS measurements verified the presence of the in-situ composite layer on the surface of the steels initially tested with quartzite: the level of silicon found from the surface region of the cross-sections was substantially higher in the quartzite-tested specimens than in the granite-tested specimens

even after the second round of the wear tests with granite. Other researchers [59,60] have also presented similar type of findings when abrading steels of different initial hardness with SiC based 'sandpaper'. One result of these studies was that in the case of soft steels, the particles from the sandpaper became embedded in the surface of the steel, whereas in the case of harder steels, the steel wear debris was sticking into the sandpaper.

Based on the findings of Publication II, the studies of these phenomena were continued with steels of different hardness and other types of wear resistant materials. The results from Publication III are presented in Figure 14. The results of the wear tests where granite was used as abrasives in both of the two test rounds are marked as GR+GR. In a similar manner, the results from the wear tests where the first round (running-in) was conducted with quartzite and the second round with granite as abrasives are marked as Q+GR.

The first observation is that the results obtained for WR2 of 480 HV hardness are similar in both Publications II and III, indicating that the test method is valid and produces repeatable results. Secondly, for softer steels, the combined wear losses of test rounds one and two are higher for quartzite+granite tests compared to the tests conducted with granite only. This indicates that the composite layer is too weak, or too weakly bonded to the sample surface, and is therefore easily worn or peeled off by the forces arising from the abrasive granite particles.

For materials in the hardness range of 400-800 HV, increased wear resistance is observed when the material is first worn with quartzite. This effect is most clearly observed with cast iron specimens, which contain hard chromium carbides in a softer steel matrix. When the wear resistance of the matrix phase is increased by the formation of the composite layer, the pull-out of carbides is also substantially decreased. In addition, the deformation of the matrix decreases due to this "reinforcing" effect by the composite layer. Consequently, also the carbide particles are not crushed so easily due to the increased support from the matrix. Similar behavior is observed also for the MMC material, which contains recycled and crushed WC-Co carbides in a tool steel matrix. As the cast iron, also this material benefits from the formation of the composite layer by intermixing of the matrix material and the abrasives.

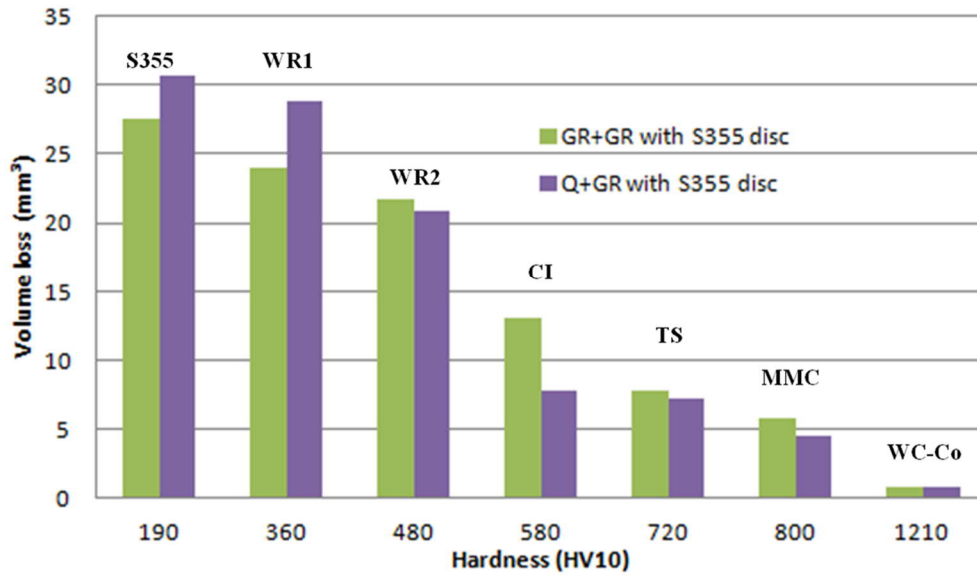

Figure 14. Results of the wear tests with two different running-in practices [Publication III].

In the two-round tests on the WC-Co specimens, the results did not appear to depend on the abrasive type used in the first round tests, i.e., whether it was granite or quartzite. However, in Publication I it was noticed that quartzite is causing higher wear rates than granite in WC-Co because of the excess wearing of the cobalt matrix. In this case, however, even though the support provided by cobalt is lacking, the carbide skeleton appears to withstand the stresses arising from the granite particles without breakage. In other studies [42,61,62], it has been found that granite can substitute the binder phase in WC-Co materials during a wear test, which may also be the case in the present study. Figure 15 shows a schematic example of this mechanism in WC-Co drill bits during drilling of granite [41].

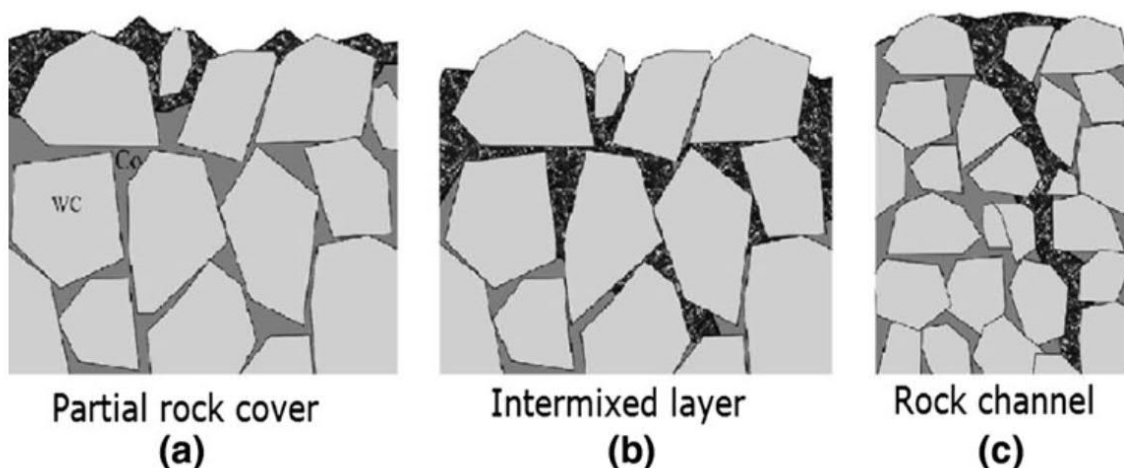

Figure 15. Different interactions between granite and a WC-Co rock drill button during drilling [41].

The cross-sectional images in Figure 16 were taken with a scanning electron microscope using back scatter electrons that provide elemental contrast, i.e., the denser the material (containing heavier elements), the lighter the color and vice versa. Because of that, the rock materials appear in the images in darker shades of gray, while steels/ferrous materials provide a lighter/brighter contrast. The cross-sectional image taken from the WR1 sample reveals the reason behind the material's increased wear rate in the granite test. The specimen was originally worn with quartzite, and the mechanically mixed layer is still slightly visible as a thin interface between the steel and the surface layer. This layer was originally quite thick, but the further abrasion process with granite of high compressive strength directed high stresses to the layer, resulting in high wear rates. In the top layer of the WR1 specimen, a combination of granitic material and steel can be observed. In the case of the CI specimen, there is still a layer of quartzite particles clearly visible in the cross section below the granitic material.

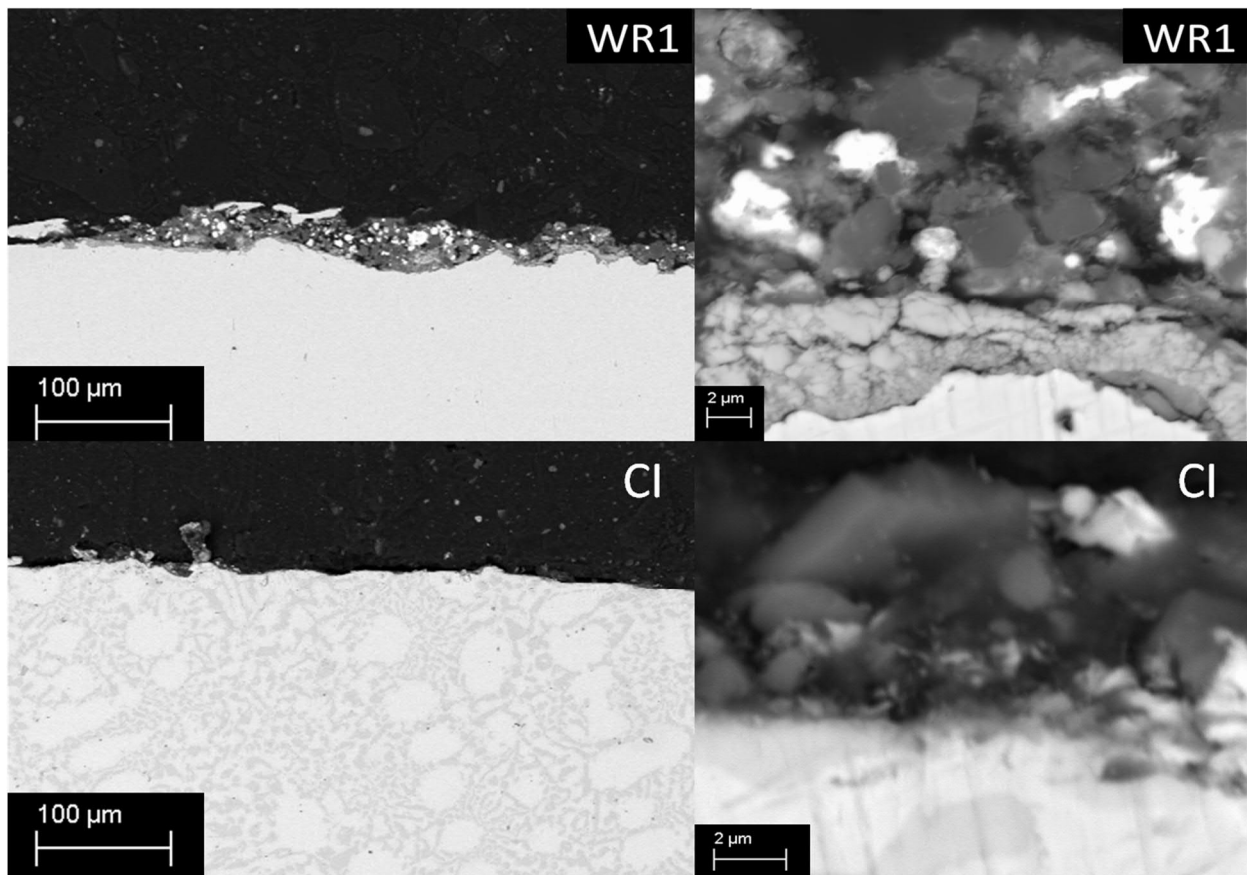

Figure 16. Cross-sections of the WR1 and CI specimens after the crushing pin-on-disc tests conducted with quartzite followed by granite.

5.3 Frictional behavior of worn surfaces

Based on the results presented in Publication III, there was interest to study also the tribological properties of the differently worn surfaces. From the materials used in Publication III, the following materials were selected for the friction studies: the lower hardness wear

resistant steel (WR1), cast iron (CI), tool steel (TS), and WC-Co hardmetal. Of each material, three different surfaces were prepared; a polished, wear tested with quartzite, and wear tested with granite. As a slider, two geometrically different indenters were used, a diamond Rockwell indenter with a small conical tip producing a high contact stress, and a WC-Co spherical indenter with a large diameter producing a larger contact area and therefore a lower contact stress.

The results of the 50 N normal load friction tests are presented in Figure 17. For the polished surfaces of steel and cast iron specimens, the measured friction values are similar for both the Rockwell tip and the WC-Co indenters. In the case of polished WC-Co surfaces, the use of a WC-Co indenter leads to increased friction values due to the increased adhesion between the mating surfaces of similar material and hardness. The quartzite-worn surfaces of WR1 tested with the Rockwell indenter give quite high friction values, and in general, high friction correlates with high wear rates, which is the case also here. On the other hand, for WR1 the friction values appear to be more or less identical for polished and granite worn samples tested with both sliders. This might arise from the extensive material removal from the sample surface during the wear tests with granite, resulting in the low level of abrasive residues on the worn surfaces, and also from the relatively low hardness of the steel itself.

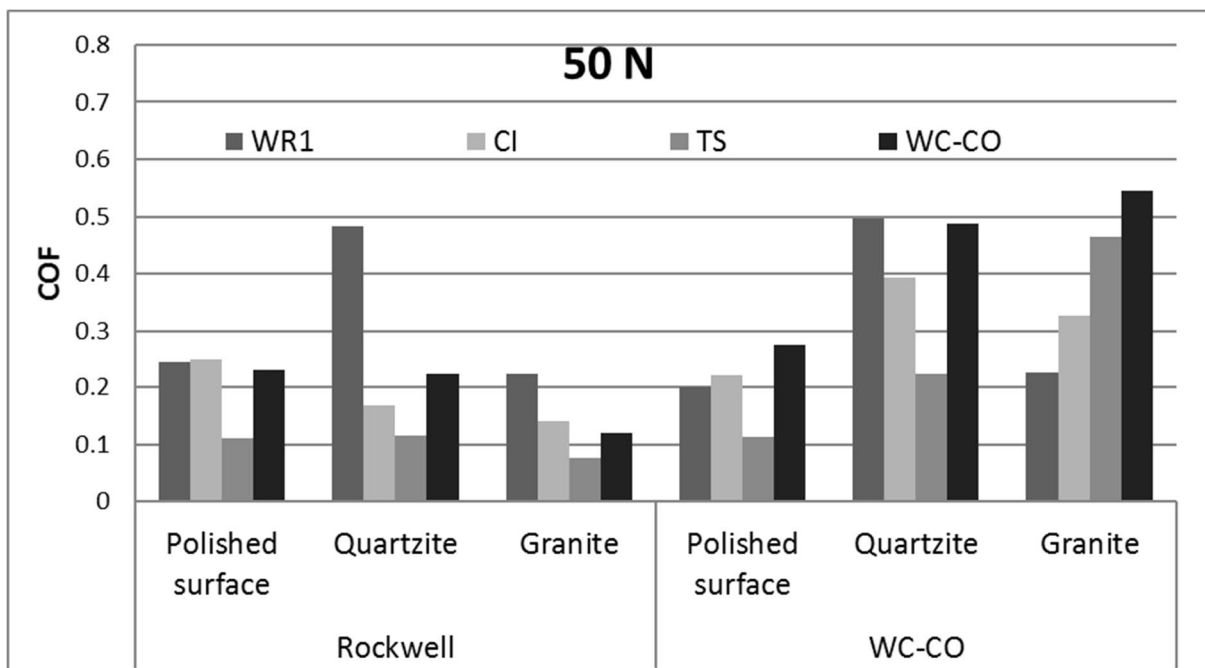

Figure 17. Frictional behavior of the studied materials tested under the load of 50 N with different counter bodies (sliders).

For the cast iron specimens, both worn surfaces give lower friction values than the polished surface when tested with the Rockwell indenter. This is due to the decreased deformability of the surface, caused by the mechanically intermixed layer of the matrix phase and quartzite particles, which are supporting both the sliding indenter and the carbides from pulling out. In

the case of the tool steel with a higher hardness than the cast iron, the level of embedment of the quartzite particles is lower, and therefore quite similar friction values are obtained with the Rockwell indenter from both the polished and quartzite tested surfaces.

In the actual wear tests, quartzite is abrading the WC-Co hardmetal the most, but this is not reflected to the friction values between the polished and quartzite tested surfaces, when the measurement is done with the Rockwell indenter. The reason for this probably is that most of the material loss is from the matrix phase, while the carbide skeleton remains quite undamaged, leading to similar friction values for both the polished and quartzite abraded surfaces. The composition of the WC-Co plays also a role here. With higher amount of the binder phase and larger carbide size, the situation may change, as the carbides cannot so well withstand the contact stresses from the sliding indenter, leading to an increase in the friction values.

When the WC-Co ball is used as a slider, all worn surfaces show higher friction values despite the fact that the actual contact stresses should be much lower than in the case of the Rockwell indenter as a slider. The WC-Co ball has a diameter of 8 mm, which means that it is more affected by the irregularities of the worn surface that can produce locally high contact stresses. In addition, at least to some extent the quartzite particles attached to the worn surfaces can affect the WC-Co ball and remove the binder phase from it, also resulting in higher friction.

For polished surfaces and surfaces worn with quartzite, the order of the determined friction coefficients of all studied materials except for the WC-Co hard metal remained the same independent of the used slider. In the case of the harder materials, i.e., CI, TS, WC-Co, worn with granite, dissimilar behavior is observed between the two sliders: while with the Rockwell indenter very low friction values were recorded, the COF values recorded with the WC-Co ball increased with increasing hardness of the tested surface. The lower values obtained with the Rockwell slider for the harder materials might be attributed to the higher level of abrasives on the surfaces. Based on the scanning electron microscope studies, it was observed that the higher the hardness of the materials, the more granitic materials were found on the wear surfaces. Based on the EDS analysis, the main mineral component found on the surfaces was feldspar, which had a quite lamellar looking appearance that might facilitate sliding on the surface and act as a lubricant. According to Pintaude et al. [63], during crushing of granite, the feldspar and quartz particles become separated, which can affect the frictional behavior of the wear surface.

The situation is different with the larger diameter WC-Co slider, which yielded significantly higher friction values than the Rockwell indenter at the normal force of 50 N. This observation is in line with the results of Heinrichs et al. [61] on the wear caused by granite to WC-Co hardmetal drill bits, which were of the same size as the WC-Co slider used in this work. In general, the amount of granitic material found on the wear surfaces becomes higher when the hardness of the material increases. In the case of the WC-Co slider, the higher measured friction values are due to the wear of the WC-Co by the removal of some of the surface grains and subsequently increasing irregularity of the ball surface.

Figure 18 shows what happens to the measured friction values when the normal force is doubled from 50 N to 100 N. A general and expected observation is that the friction, or rather the tangential force that includes both the adhesive and abrasive effects [16], increases. Especially for the polished surfaces of the softer WR1 and CI, friction more than doubles due to the increased penetration depth and increasing abrasive component in the measured tangential force values. In the case of the CI specimen, the slider also collides more frequently with the hard carbides, as was shown by the force-time curves, thus increasing the friction values. For the harder materials, i.e., the tool steel and the WC-Co hardmetal, the applied increase in the normal force does not increase the penetration depth as much, and therefore only a moderate increase in the frictional forces was observed. For all studied materials, the values obtained with the WC-Co ball slider were quite similar at both normal force levels, which is quite expected considering the ball's larger diameter and consequent shallow indentation depths.

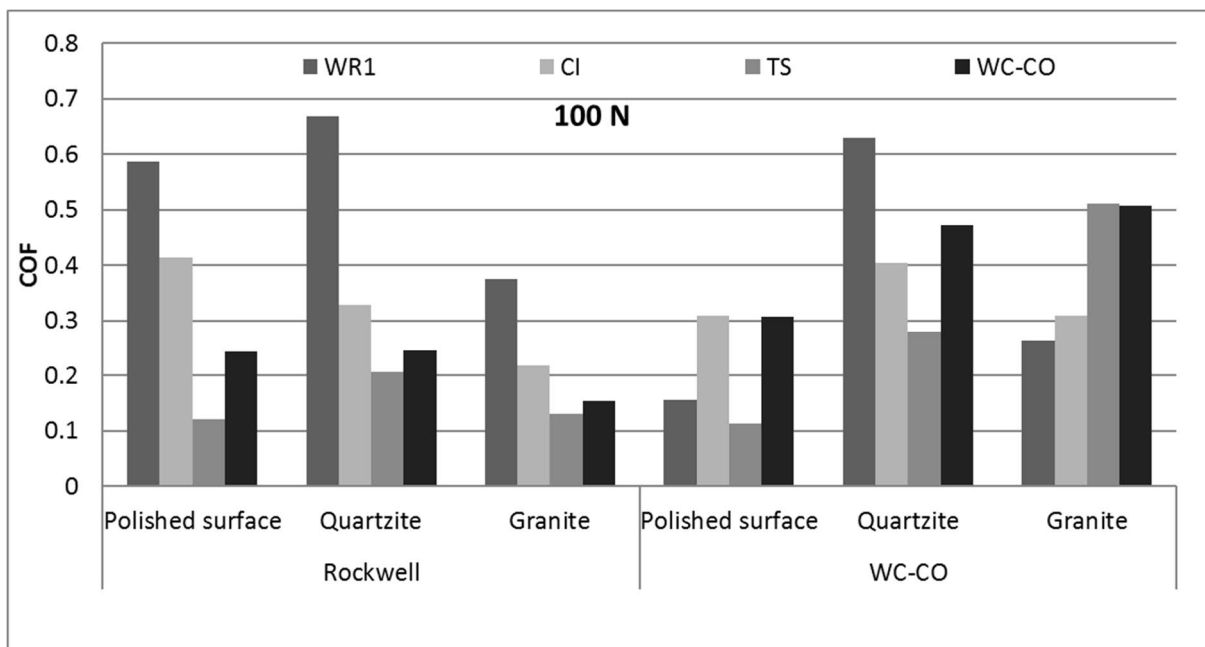

Figure 18. Frictional behavior of the studied materials tested under the normal load of 100 N with different counter bodies (sliders).

5.4 High stress abrasion of white cast irons

Publication V deals with the effect of microstructure on the abrasive wear of white cast irons (WCI), which still today, despite their long history and all the new material solutions available, are very competitive materials for wear-prone applications due to their moderately low price combined with good wear resistance. The wear resistance of WCI's can be altered by changing their compositional features such as the quantity, orientation, and morphology of the carbides, as well as by heat treatments, which mainly affect the matrix phase. The final macrostructure of the whole casting also affects the final wear behavior of the material [64].

In this work, four different heat treatments of high chromium white cast irons were studied; hardened and stress relieved (H), normalized (N), self-hardened (AC-SH), and as-cast (AC).

Generally, the hardness of wear resistant materials is used as the most important parameter in the materials selection, but based on the results of this work, it is also important to acknowledge how the hardness was measured and how it describes the actual material performance in a certain specific condition. For example, let us assume that we are using Vickers hardness measurements of 10 kg, i.e., we determine the HV10 hardness value for a material. For the high chromium white cast irons, this means that the hardness values are strongly affected by the high hardness of the carbide phase. If, however, the actual wear attacks heavily also the softer matrix phase between the carbides, the hardness of the material must be determined accordingly with a smaller indenter using a smaller load to properly relate the hardness of the material to the wear it will be experiencing.

All the four studied WCI specimens had similar carbide hardness (~1700 HV), but due to the different heat treatments, the matrix hardness varied quite much. The matrix hardness of H, N, AC-SH and AC specimens were 700 HV0.1, 740 HV0.1, 600 HV0.1 and 320 HV0.1, respectively. The bulk hardness values of the same specimens were 740 HV10, 718 HV10, 720 HV10 and 350 HV10, respectively. As seen, the bulk hardness value of the as-cast (non-heat treated) sample is clearly lower than the hardness values of all heat treated samples and follows the matrix hardness quite closely. Another observation is that although the matrix hardness of the AC-SH sample is roughly 100 HV lower than that of the other two heat treated samples, the bulk hardness values of all three heat treated samples are quite close to each other.

Based on the bulk hardness values, one might expect all the three heat treated materials to behave similarly, but that is not the case, as shown in Figure 19. Instead, it was found that the (retained) austenite-to-martensite ratio affects the wear rates and the behavior of the carbides. If the matrix is too soft, the deformation quite easily crushes the carbides, and depending on the orientation of the carbides, a cracked zone or even a cracked carbide network could be found quite deep in the material. As the hardness of the carbides is very high (~1700 HV), they easily suffer from brittle fracturing caused by the local high stresses during the abrasion process. Therefore, the carbide structure needs good support from the matrix that must be strong enough but also possess a right amount of ductility [65-67].

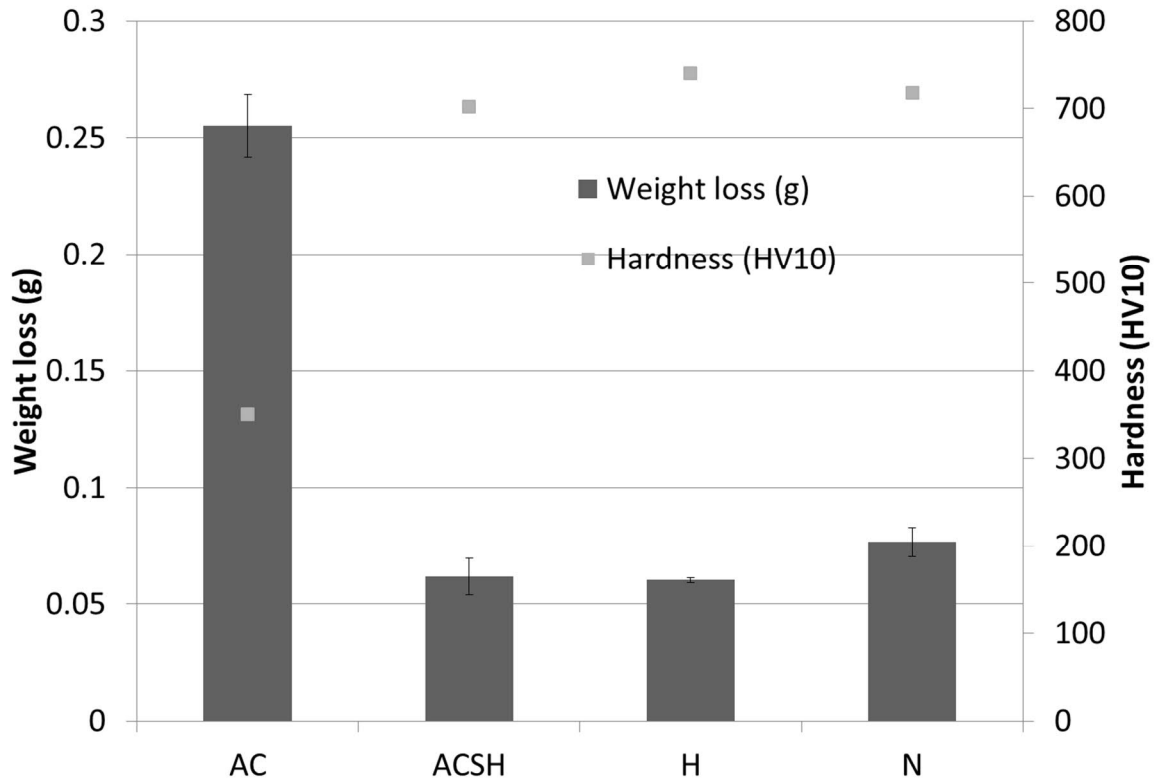

Figure 19. Results from the crushing pin on disc tests presented together with the bulk hardness values of the studied WCI specimens [Publication V].

Based on the available research papers, the beneficial carbide orientation seems to be strongly affected by the testing conditions, as quite different results can be found. Although long carbides parallel to the wear surface are generally known to improve the abrasive wear resistance [50,64,68–71], the results of Publication V and also some other studies [72–74] suggest that high stresses tend to crack the carbides quite effectively when the matrix is deformed extensively or the maximum stress region is on the interface between the carbides and the matrix. Carbides cracked into small size fragments can leave the wear surface, but some of those fragments can also embed into the matrix phase of the surface. In the case of a ferritic matrix, cracking was also observed when the long carbides were oriented perpendicular to the wear surface. In this case, the deformation zone extended quite deep below the surface, to around $\sim 100 \mu\text{m}$, and therefore the vertically oriented carbide network was not only suffering from the point size stresses due to the abrasive loading of the wear surface, but also from the bending stresses occurring due to the deformation of the soft matrix. Thus, opening of the carbide network to the wear surface, removal of the crushed carbides, and replacement of the carbides with abrasive particles will eventually flake off quite large particles when penetrating through the old carbide network and acting as a wedge during further abrasion. This kind of behavior is observed in Figure 20 in the cross-section of the soft as-cast (AC) specimen. Therefore, the role of crushed high hardness carbide particles in the further wear processes should not be neglected.

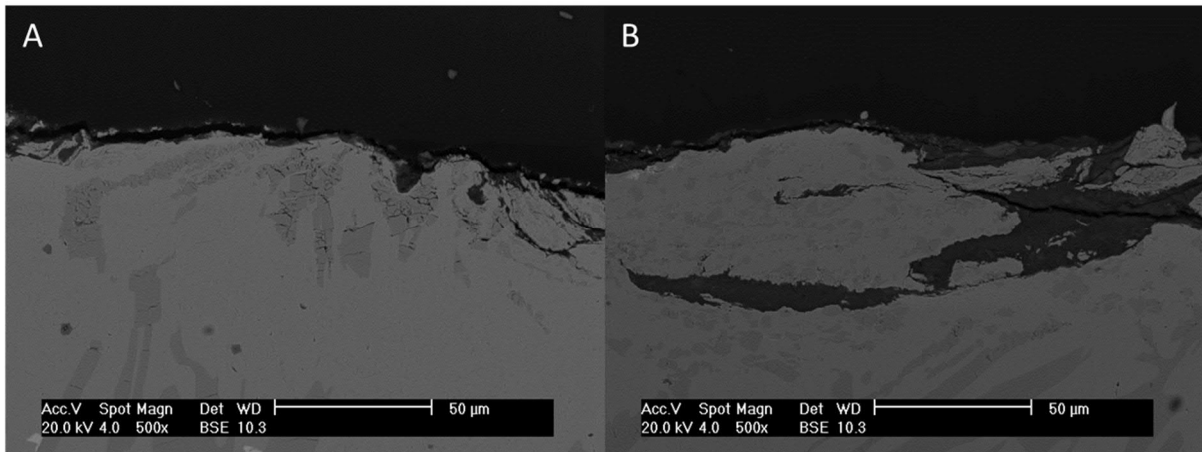

Figure 20. Cross-section of the AC specimen revealing subsurface cracking of carbides (A) and rock material penetration through the carbide network (B) [Publication V].

The deformability of the hard matrix of the normalized (N) white cast iron with mainly a martensitic microstructure was found to be so low that cracking occurred even in it alongside with the brittle carbide network. The matrix cracking was observed to lead to the removal of entire uncracked carbides, when they were oriented with their long axis parallel to the wear surface. Similar observations have been made for example by Badish et al. [75] using the ball cratering test method. The other two white cast irons (H and AC-SH) contained also austenite in their microstructure, which was found to be beneficial for the wear resistance of the materials. The self-hardened white cast iron (AC-SH) with a lower matrix hardness (~600 HV) showed a similar or slightly better wear resistance than the hardened and stress relieved (H) version with a matrix hardness of 700 HV. This material also had thin long carbides oriented perpendicular to the wear surface. The carbides also formed columnar zones, which restricted the sliding abrasion contact with the matrix, forcing the cutting marks to remain short. The thin carbides also bent and deformed along the wear surfaces. Lotta et al. [76] stated that the coarser carbide size of the conventional high chromium white cast irons is one of the main influencing factors for their superior wear resistance compared to cast irons made by spray forming, which contain much finer carbides. Based on the results of this study and related scientific literature, it is obvious that the abrasion process in white cast irons is very case sensitive, and only results obtained in similar wear environments should be compared with each other.

6. Conclusions and research questions revisited

The main aim of this work was to examine the mineral properties that affect the abrasive wear rates in steels, white cast irons, and WC-Co hardmetals. The studied (wear resistant) materials had different microstructures, which affects significantly the outcomes of the wear processes in different circumstances: the steels can be considered as more or less homogeneous materials, while the white cast irons and the WC-Co hardmetals have clearly a heterogeneous microstructure consisting of distinctly different components. On the other hand, there are also clear differences between the microstructures of the white cast irons and hardmetals, for example as regards the amount and role of the hard phase or the properties of the matrix phase of their structure. In the WC-Co hardmetals, the high amount of the hard carbide phase gives the material a very high bulk hardness, which in many applications gives an excellent abrasive wear resistance for the material. However, also the relatively low fraction of the much softer matrix or binder phase may obtain a wear controlling role in certain circumstances. In the case of white cast irons, the properties and wear behavior of the materials are largely dictated by the matrix rather than by the carbides.

The abrasive properties of minerals can be described by many different parameters, each of which may have a different role in different circumstances and wear modes. Abrasiveness, for example, can be used to estimate and compare the harshness of the rocks taken from different quarries. The abrasiveness values used in this work were determined according to the French standard NFP18-579 test, which gives also the crushability value of the rock based on the sieving results after the test. For example in the present crushing pin-on-disc tests, the abrasiveness values did not properly describe or differentiate the wear caused by the studied four rocks, as shown also by Valtonen et al. [13] in dry pot tests with freely flowing abrasives.

In the case of steels, the wear rate is generally observed to decrease with increasing crushability of the abrasive. For hardmetals, the trend is the opposite, i.e., the wear rate normally increases with increasing crushability. This difference can be explained by the different microstructures and consequently different wear mechanisms controlling the material removal in these two different types of materials. In the case of WC-Co hardmetals, the small (crushed) particles can more easily attack the binder phase and in that way increase the wear rate. In steels with a more homogenous microstructure, the material removal occurs through a more general cutting process, which requires that the abrasive particles can withstand reasonable compressive forces without fracturing or becoming crushed in order to maintain their ability to cut the surface efficiently.

The uniaxial compressive strength as a rock property is quite similar to the crushability value of the material, i.e., it also describes how easily the rock becomes crushed. However, some of the rocks are quite anisotropic, and the compressive strength varies depending on the direction of loading relative to the lamellae of the microstructure. For example, gneiss with a highly anisotropic microstructure behaved very similarly with the more isotropic granite, although it had a much lower UCS value. The correlation between UCS values and the volume losses in steels and hardmetals was quite poor, but based on the general properties of gneiss,

its UCS value might in reality be higher than the value used in this work, as implied also by the crushability values. One possible explanation for the apparent discrepancy between the UCS and crushability values of gneiss is the size effect, i.e., the UCS values were determined for large blocks of rock, while in the crushability tests the size of the gravel was only 4-6.3 mm.

The most important wear related mineral component in the rocks is evidently quartz, largely due to its high hardness. Nevertheless, in the present studies it was observed that despite the clearly highest nominal hardness of quartzite, it did not provide the harshest wear environment for example for steels. In the case of WC-Co materials, on the other hand, a clear trend of increasing wear rate with increasing quartz content in the abrasive (and increasing hardness) could be observed.

The size of the abrasives is also an important factor, both in the absolute scale and relative to the size of the microstructural features in the wearing material. As presented for example by Andrade et al. [60], higher contact stresses are generally observed with larger particles, stemming from the fact that despite a larger nominal contact area, large abrasive particles are rarely completely spherical and smooth but can transmit high loads to very small areas, easily creating very high local contact stresses [30-34].

From the wearing material point of view, for steels the most important property of the abrasive is the compressive strength of the rock, while for the WC-Co hardmetals, crushability of the abrasives is a far more crucial property. In order to be able to cause wear in steels, the rock needs to have a sufficiently high compressive strength, otherwise the abrasive particles are crushed with only very limited amount of cutting (if any) taking place on the steel surface. However, some embedment of abrasives might occur, depending on the hardness of the steel surface. On the other hand, if the compressive strength of the abrasive is very high, the amount of wear can finally remain relatively small, as in the course of the wear process, the abrasives can only become more rounded instead of producing new sharp edges through fracturing. From a practical point of view, this (low wear) hardly is a problem, but from a testing (and ranking) point of view, too low wear rate can make drawing of reliable conclusions quite difficult. WC-Co hardmetals with very high bulk hardness, in turn, can resist abrasive wear extremely well as long as the abrasive particles remain large enough, i.e., their crushability has a relatively low value. As already explained above, the reason for this behavior is that only small enough abrasives can cause wear of the binder phase, leading to a situation where the supporting material for the carbides gradually disappears and the carbides either fracture or pull out from the matrix. In the case of white cast irons, the most important property related to high stress abrasive wear is the high enough hardness of the matrix, combined with sufficient ductility to provide the necessary support for the hard carbides. The orientation, size, and shape of the carbides also affect the wear behavior of the white cast irons markedly.

From the discussion above, it is evident that the effects of mineral properties on the progress, extent, and mechanisms of wear can be quite different depending on the wearing material. This underlines the notion of wear being a system rather than a material property, although 'wear resistance' is a commonly cited property for example in material data sheets. Furthermore, the 'wear resistance' values are quite often obtained using the standard rubber

wheel tests, which are commonly known to correlate very poorly with almost all real life applications.

The results of this work also show that the material properties can change even quite drastically, when the material is subjected to an abrasive wear environment. In addition, the changes brought about by different abrasives can be very different. For example, some of them are forming mechanically mixed layers with the wearing materials, affecting the further wear rates, while some other of them may work-harden the wear surface quite significantly and in that way affect the wear process. There can also appear changes in the frictional behavior of the material (or material pair), which again may have an effect on the further wear rate of the material.

The novel scientific contributions resulting from this work are as follows:

1. Comparison of the effects of various abrasive properties on the high-stress abrasion of steels and hardmetals
2. Elucidation of the effects of embedded quartzite on high-stress abrasive wear of selected materials
3. New approaches for the studies of the tribological behavior of worn surfaces
4. Improvement of the theoretical understanding of the effects of microstructural features on the high stress abrasive wear behavior of white cast irons

In Chapter 1, two specific research questions were introduced. Many of the topics of these questions were discussed already in the preceding two pages, but in the following, they are once more revisited to give a concise answer to each question based on the results obtained during the course of this work.

1. How do the different properties of rocks (minerals) affect the abrasive wear processes, and how should that be taken into account in the selection of materials for different wear-prone processes?

In the case of steels, the most important abrasive property affecting the wear process is the compressive strength of the rock. In order to cause notable wear in steels (mostly by cutting), the rock needs to have a sufficiently high compressive strength. If the strength is too low, the abrasive particles are crushed before they cause any marked cutting of the steel surface. On the other hand, if the compressive strength is overly high, the amount of wear may also remain low as the abrasives become rounded and no new sharp edges are formed for cutting. The latter, of course, applies only to a closed system (such as a batch operated wear test), where the same abrasives remain in the system for extended periods of time.

For WC-Co hardmetals, crushability is one of the most important properties of (initially large) abrasives, as it determines whether or not the abrasives will be capable of 'eating out' the soft cobalt matrix of the composite structure. If the abrasive particles remain large enough

throughout the test or an industrial process, the hardmetals with high bulk hardness can usually survive with little wear damage even in the harshest abrasive environments.

In the case of white cast irons, the structure combines a hard carbide phase and a metallic matrix, the hardness of which is an extremely important factor. An essential thing to notice is that the matrix phase hardness affects also the wear behavior of the hard carbide phase. In a low hardness matrix, such as ferrite, the deformation during the wear process can be very large, but the carbides cannot deform with it, resulting in the cracking and crushing of the carbides. If the matrix hardness is high instead, such as in martensite, the matrix can deform only so little that the carbides are cracked and crushed due to the local high point stresses during the abrasion process. As a conclusion, the white cast irons need a matrix with high hardness but the right amount of ductility, such as an essentially martensitic structure with some retained austenite. In addition, the orientation and shape of the carbides affect the wear rates of white cast irons in high-stress abrasion, the most beneficial structure containing columnar thin carbides perpendicular to the wear surface. If the carbides are parallel to the wear surface, they are much more easily crushed or removed by the contact stresses affecting the interface between the carbide and the matrix. In some cases, the crushed carbides are removed and replaced by the abrasive material, producing 'wedges' that cause flaking of the surface.

2. How do the in-situ composite layers possibly forming on the wear surfaces affect the wear behavior of steels, cast irons and hardmetals?

The formation and effects of the in-situ composite (or mechanically mixed) layers on the wear surfaces depend on both the used abrasives and the wearing material. In the present studies, the focus has been on the properties and behavior of quartzite in the formation of such layers. Quartzite is known for its high hardness but also for its very low compressive strength, which is why it tends to form plenty of fine size particles during high stress abrasion. In practice, this means that the lower the hardness of the surface being worn by quartzite is, the more particles can become embedded into the surface of the material. With steels, two different kinds of behavior depending of the hardness of the steels was observed in this work. In the low hardness steels, the layer grew quite thick, and under the further abrasive action, the wear rate was increased by flaking of this layer.

In medium hardness steels, an improvement in the wear resistance due to the forming in-situ composite layer was observed. The main reason for this positive effect from the wear resistance point of view was the increased hardness of the surface composite layer. When the hardness of the steel increased further, the reinforcing effect started to decrease due to decreasing embedment of the abrasive particles, when the hardness of the surface started to approach the hardness of quartzite. Still, even with the tool steel, some improvement in the wear resistance could be observed.

The formation of the in-situ composite layer in the cast irons depends only on the matrix of the material, as the carbide phase has a too high hardness for the quartzite to embed in it. According to the current results, the wear performance of the studied cast irons was

remarkably better after the formation of the in-situ composite layer due to the increased surface hardness of the matrix. In the case of WC-Co hardmetals, no evident effect of possible quartzite embedment was observed. The obvious explanation for this is that quartzite can affect only the binder phase, whose volume fraction is relatively small compared to the carbide phase of extremely high hardness.

References

- [1] L. Astruc, R. Vargiolu, H. Zahouani, Wear assessments of prehistoric instruments, *Wear*. 255 (2003) 341–347. doi:10.1016/S0043-1648(03)00173-X.
- [2] C. Reichl, M. Schatz, G. Zsak, *World Mining Data 2016*, Fed. Minist. Sci. Res. Econ. Austria. 31 (2016) 1–255.
- [3] K. Holmberg, P. Aivi Kivikyt€ O-Reponen, P. H€ Arkisaari, K. Valtonen, A. Erdemir, Global energy consumption due to friction and wear in the mining industry, (2017). doi:10.1016/j.triboint.2017.05.010.
- [4] S. Jacobson, S. Hogmark, Surface modifications in tribological contacts, *Wear*. 266 (2009) 370–378. doi:10.1016/j.wear.2008.04.035.
- [5] J. Angseryd, A. From, J. Wallin, S. Jacobson, S. Norgren, On a wear test for rock drill inserts, *Wear*. 301 (2013) 109–115. doi:10.1016/j.wear.2012.10.023.
- [6] S. Olovsjö, R. Johanson, F. Falsafi, U. Bexell, M. Olsson, Surface failure and wear of cemented carbide rock drill buttons-The importance of sample preparation and optimized microscopy settings, *Wear*. 302 (2013) 1546–1554. doi:10.1016/j.wear.2013.01.078.
- [7] I. Konyashin, B. Ries, Wear damage of cemented carbides with different combinations of WC mean grain size and Co content. Part II: Laboratory performance tests on rock cutting and drilling, *Int. J. Refract. Met. Hard Mater*. 45 (2014) 230–237. doi:10.1016/j.ijrmhm.2014.04.017.
- [8] X. Ren, H. Miao, Z. Peng, A review of cemented carbides for rock drilling: An old but still tough challenge in geo-engineering, *Int. J. Refract. Met. Hard Mater*. 39 (2013) 61–77. doi:10.1016/j.ijrmhm.2013.01.003.
- [9] M. Petrica, E. Badisch, T. Peinsitt, Abrasive wear mechanisms and their relation to rock properties, *Wear*. 308 (2013) 86–94. doi:10.1016/j.wear.2013.10.005.
- [10] G. Barzegari, A. Uromeihy, J. Zhao, Parametric study of soil abrasivity for predicting wear issue in TBM tunneling projects, *Tunn. Undergr. Sp. Technol. Inc. Trenchless Technol. Res*. 48 (2015) 43–57. doi:10.1016/j.tust.2014.10.010.
- [11] P.D. Jakobsen, J. Lohne, Challenges of methods and approaches for estimating soil abrasivity in soft ground TBM tunnelling, *Wear*. 308 (2013) 166–173. doi:10.1016/J.WEAR.2013.06.022.
- [12] H. Käsling & K. Thuro, Determining rock abrasivity in the laboratory, n.d. http://www.geo.tum.de/people/thuro/pubs/2010_eurock_abrasivity.pdf (accessed March 2, 2018).
- [13] K. Valtonen, V. Ratia, N. Ojala, V.-T. Kuokkala, Comparison of laboratory wear test results with the in-service performance of cutting edges of loader buckets, *Wear*. 388–389 (2017) 93–100. doi:10.1016/j.wear.2017.06.005.
- [14] Loader bucket cutting edge with longer service life - Hardox Wearparts, (n.d.).

<https://www.hardoxwearparts.com/ssab-cases/loader-bucket-cutting-edge-with-longer-service-life> (accessed March 2, 2018).

- [15] P.D. Jakobsen, L. Langmaack, F. Dahl, T. Breivik, Development of the Soft Ground Abrasion Tester (SGAT) to predict TBM tool wear, torque and thrust, *Tunn. Undergr. Sp. Technol.* 38 (2013) 398–408. doi:10.1016/J.TUST.2013.07.021.
- [16] I.M. Hutchings, *Tribology: Friction and Wear of Engineering Materials*, Edward Arnold, 1992.
- [17] I.M. Hutchings, *ASM Handbook, Volume 8, Mechanical Testing and Evaluation, The Solid Particle Erosive Wear Testing*, ASM International, n.d.
<http://products.asminternational.org/hbk/index.jsp>.
- [18] *Engineering Tribology*, Elsevier, 1993. doi:10.1016/S0167-8922(08)70585-6.
- [19] Tribology series, (n.d.). http://ac.els-cdn.com/S0167892208705856/1-s2.0-S0167892208705856-main.pdf?_tid=c5e856e0-fc56-11e3-a846-00000aab0f6b&acdnat=1403693717_6d0679a9592f7424ccfaae039a224437 (accessed June 25, 2014).
- [20] B. Bhushan, *Modern tribology handbook*, CRC Press, 2001.
- [21] R. Nilsson, F. Svahn, U. Olofsson, Relating contact conditions to abrasive wear, *Wear.* 261 (2006) 74–78. doi:10.1016/j.wear.2005.09.024.
- [22] ASM International. Handbook Committee., *ASM handbook*, n.d.
- [23] K.-H. Zum Gahr, *Microstructure and wear of materials*, Elsevier, 1987.
- [24] G.W. Stachowiak, A.W. Batchelor, *Engineering Tribology*, in: *Eng. Tribol.*, 2013. doi:10.1016/B978-0-12-397047-3.00018-7.
- [25] G.W. Stachowiak, A.W. Batchelor, Chapter 11 – Abrasive, Erosive and Cavitation Wear, in: *Eng. Tribol.*, 2014: pp. 525–576. doi:10.1016/B978-0-12-397047-3.00011-4.
- [26] G.W. Stachowiak, A.W. Batchelor, *Engineering Tribology*, in: *Eng. Tribol.*, 2014. doi:10.1016/B978-0-12-397047-3.00019-9.
- [27] Metso, *Basics in minerals processing*, (2015) 354.
- [28] *Loose Abrasive Processes*, (1974) 499–530.
- [29] G.J. Gore, J.D. Gates, Effect of hardness on three very different forms of wear, 204 (1997).
- [30] D.V. De Pellegrin, G.W. Stachowiak, Sharpness of abrasive particles and surfaces, *Wear.* 256 (2004) 614–622. doi:10.1016/j.wear.2003.10.004.
- [31] G.B. Stachowiak, G.W. Stachowiak, The effects of particle characteristics on three-body abrasive wear, 249 (2001) 201–207.
- [32] G.B. Stachowiak, G.W. Stachowiak, Wear mechanisms in ball-cratering tests with large abrasive particles, *Wear.* 256 (2004) 600–607. doi:10.1016/j.wear.2003.10.029.
- [33] G.W. Stachowiak, Particle angularity and its relationship to abrasive and erosive wear,

- Wear. (2000) 214–219.
- [34] D.V. De Pellegrin, G.W. Stachowiak, Simulation of three-dimensional abrasive particles, *Wear*. 258 (2005) 208–216. doi:10.1016/j.wear.2004.09.040.
- [35] G.W. (Gwidon W.. Stachowiak, A.W. (Andrew W.. Batchelor, *Engineering tribology*, n.d.
- [36] G.B. Stachowiak, G.W. Stachowiak, Wear mechanisms in ball-cratering tests with large abrasive particles, *Wear*. 256 (2004) 600–607. doi:10.1016/j.wear.2003.10.029.
- [37] N.B. Dube, I.M. Hutchings, Influence of particle fracture in the high-stress and low-stress abrasive wear of steel, *Mater. Sci.* (1999) 0–10.
- [38] M.R. Thakare, J.A. Wharton, R.J.K. Wood, C. Menger, Effect of abrasive particle size and the influence of microstructure on the wear mechanisms in wear-resistant materials, *Wear*. 276–277 (2012) 16–28. doi:10.1016/j.wear.2011.11.008.
- [39] I. Sevim, I.B. Eryurek, *Materials & Design* Effect of abrasive particle size on wear resistance in steels, *Design*. 27 (2006) 173–181. doi:10.1016/j.matdes.2004.10.010.
- [40] M. Olsson, K. Yvell, J. Heinrichs, M. Bengtsson, S. Jacobson, Surface degradation mechanisms of cemented carbide drill buttons in iron ore rock drilling, *Wear*. 388–389 (2017) 81–92. doi:10.1016/j.wear.2017.03.004.
- [41] A. Gupta, S. Chattopadhyaya, S. Hloch, Critical Investigation of Wear Behaviour of WC Drill Bit Buttons, *Rock Mech. Rock Eng.* 46 (2012) 169–177. doi:10.1007/s00603-012-0255-9.
- [42] U. Beste, A. Lundvall, S. Jacobson, Micro-scratch evaluation of rock types—a means to comprehend rock drill wear, *Tribol. Int.* 37 (2004) 203–210. doi:10.1016/S0301-679X(03)00038-0.
- [43] O. Haiko, M. Somani, D. Porter, P. Kantanen, J. Kömi, N. Ojala, V. Heino, Comparison of impact-abrasive wear characteristics and performance of direct quenched (DQ) and direct quenched and partitioned (DQ&P) steels, *Wear*. 400–401 (2018). doi:10.1016/j.wear.2017.12.016.
- [44] E. Vuorinen, N. Ojala, V. Heino, C. Rau, C. Gahm, Erosive and abrasive wear performance of carbide free bainitic steels - Comparison of field and laboratory experiments, *Tribol. Int.* 98 (2016). doi:10.1016/j.triboint.2016.02.015.
- [45] N. Ojala, K. Valtonen, V. Heino, M. Kallio, J. Aaltonen, P. Siitonen, V.-T. Kuokkala, Effects of composition and microstructure on the abrasive wear performance of quenched wear resistant steels, *Wear*. 317 (2014). doi:10.1016/j.wear.2014.06.003.
- [46] L.A. Dutra, J. Daniel, B. De Mello, M. Camargo, S. De Macêdo, C. Scandian, Correlation among abrasive wear tests 1, (2013) 173–184. doi:10.1002/ls.
- [47] L.R.D. Jensen, H. Friis, E. Fundal, P. Møller, P.B. Brockhoff, M. Jespersen, Influence of quartz particles on wear in vertical roller mills. Part I: Quartz concentration, *Miner. Eng.* 23 (2010) 390–398. doi:10.1016/j.mineng.2009.11.014.
- [48] L.R.D. Jensen, E. Fundal, P. Møller, M. Jespersen, Prediction of wear rates in

- comminution equipment, *Wear*. 269 (2010) 525–533.
doi:10.1016/j.wear.2010.05.007.
- [49] L.R.D. Jensen, E. Fundal, P. Møller, M. Jespersen, Wear mechanism of abrasion resistant wear parts in raw material vertical roller mills, *Wear*. 271 (2011) 2707–2719. doi:10.1016/j.wear.2011.03.018.
- [50] E. Albertin, A. Sinatora, Effect of carbide fraction and matrix microstructure on the wear of cast iron balls tested in a laboratory ball mill, *Wear*. 250 (2001) 492–501.
- [51] V. Ratia, V. Heino, K. Valtonen, M. Vippola, A. Kemppainen, P. Siitonen, V.-T. Kuokkala, Effect of abrasive properties on the high-stress three-body abrasion of steels and hard metals, *Tribologia*. 32 (2014).
- [52] H. Klaasen, J. Kübarsepp, Abrasive wear performance of carbide composites, *Wear*. 261 (2006) 520–526. doi:10.1016/j.wear.2005.12.004.
- [53] Cerchar Abrasivity test - Geotechdata.info, (n.d.).
<http://www.geotechdata.info/geotest/Cerchar-Abrasivity-test.html> (accessed March 2, 2018).
- [54] R.J. Plinninger, Hardrock abrasivity investigation using the Rock Abrasivity Index (RAI), Williams, al., (Eds.), *Geol. Act. Taylor Fr. London*. (2010) 3445–3452.
- [55] Crushability standard 0686 Metso.pdf, (n.d.).
- [56] D. Cho, B. Bhushan, J. Dyess, Tribology International Mechanisms of static and kinetic friction of polypropylene, polyethylene terephthalate, and high-density polyethylene pairs during sliding, *Tribology Int.* 94 (2016) 165–175. doi:10.1016/j.triboint.2015.08.027.
- [57] J. Terva, V. Kuokkala, P. Kivikytö-reponen, The edge effect of specimens in abrasive wear testing, *Finnish J. Tribol.* 31 (2012) 27–35.
- [58] Q. Shao, Continuum model of abrasive layer in an abrasive wear test, *Wear*. 259 (2005) 36–43. doi:10.1016/j.wear.2005.03.015.
- [59] T. Hisakado, K. Miura, H. Suda, Effects of debris transfer and abrasive particle damage on the abrasive wear of hardened bearing steel, *Wear*. 247 (2001) 24–32.
- [60] M.F.C. Andrade, R.P. Martinho, F.J.G. Silva, R.J.D. Alexandre, A.P.M. Baptista, Influence of the abrasive particles size in the micro-abrasion wear tests of TiAlSiN thin coatings, *Wear*. 267 (2009) 12–18. doi:10.1016/j.wear.2008.12.114.
- [61] J. Heinrichs, M. Olsson, S. Jacobson, Initial deformation and wear of cemented carbides in rock drilling as examined by a sliding wear test, *Int. J. Refract. Met. Hard Mater.* 64 (2017) 7–13. doi:10.1016/j.ijrmhm.2016.12.011.
- [62] U. Beste, S. Jacobson, A new view of the deterioration and wear of WC/Co cemented carbide rock drill buttons, *Wear*. 264 (2008) 1129–1141. doi:10.1016/j.wear.2007.01.030.
- [63] G. Pintaude, A. Tschiptschin, D. Tanaka, A. Sinatora, The particle size effect on abrasive wear of high-chromium white cast iron mill balls, *Wear*. 250 (2001) 66–70.

<http://www.sciencedirect.com/science/article/pii/S0043164801006639> (accessed June 26, 2014).

- [64] J.A. Hawk, G.L. Li, Solidification Structure and Abrasion Resistance of High Chromium White Irons, 28 (1997).
- [65] T.W. Chenje, D.J. Simbi, E. Navara, Relationship between microstructure, hardness, impact toughness and wear performance of selected grinding media for mineral ore milling operations, *Mater. Des.* 25 (2004) 11–18. doi:10.1016/S0261-3069(03)00168-7.
- [66] J.D.B. de Mello, A. Polycarpou, Abrasive wear mechanisms of multi-components ferrous alloys abraded by soft, fine abrasive particles, *Wear.* 269 (2010) 911–920. doi:10.1016/j.wear.2010.08.025.
- [67] C. Çetinkaya, An investigation of the wear behaviours of white cast irons under different compositions, *Mater. Des.* 27 (2006) 437–445. doi:10.1016/j.matdes.2004.11.021.
- [68] G. Pintaude, F.G. Bernardes, M.M. Santos, a. Sinatora, E. Albertin, Mild and severe wear of steels and cast irons in sliding abrasion, *Wear.* 267 (2009) 19–25. doi:10.1016/j.wear.2008.12.099.
- [69] Y. Matsubara, N. Sasaguri, K. Shimizu, K. Yu, Solidification and abrasion wear of white cast irons alloyed with 20 % carbide forming elements, 250 (2001) 502–510.
- [70] J.A. Hawk, Effect of carbide orientation on abrasion of high Cr white cast iron, 189 (1995).
- [71] J.A. Hawk, O.N. Dogan, G. Laird II, J.A. Hawk US, 183 (1995) 342–349.
- [72] J.J. Coronado, a. Sinatora, Load effect in abrasive wear mechanism of cast iron with graphite and cementite, *Wear.* 267 (2009) 6–11. doi:10.1016/j.wear.2008.12.071.
- [73] J.J. Coronado, Effect of load and carbide orientation on abrasive wear resistance of white cast iron, *Wear.* 270 (2011) 823–827. doi:10.1016/j.wear.2011.02.009.
- [74] J.J. Coronado, Effect of (Fe,Cr)₇C₃ carbide orientation on abrasion wear resistance and fracture toughness, *Wear.* 270 (2011) 287–293. doi:10.1016/j.wear.2010.10.070.
- [75] E. Badisch, C. Mitterer, Abrasive wear of high speed steels: Influence of abrasive particles and primary carbides on wear resistance, *Tribol. Int.* 36 (2003) 765–770. doi:10.1016/S0301-679X(03)00058-6.
- [76] J. Lotta, S.-P. Hannula, Microstructure and wear resistance of spray formed and conventionally cast high-chromium white iron, *Materwiss. Werksttech.* 45 (2014) 727–735. doi:10.1002/mawe.201400309.

APPENDIX: Original publications

Publication I

Vilma Ratia, Vuokko Heino, Kati Valtonen, Minnamari Vippola, Anu Kemppainen, Pekka Siitonen and Veli-Tapani Kuokkala

Effect of abrasive properties on the high-stress three-body abrasion of steels and hardmetals

Finnish Journal of Tribology 32(2014) 3-18.

©2014 Finnish Tribology Society

Reprinted with permission

EFFECT OF ABRASIVE PROPERTIES ON THE HIGH-STRESS THREE-BODY ABRASION OF STEELS AND HARD METALS

VILMA RATIA^{1*}, VUOKKO HEINO¹, KATI VALTONEN¹, MINNAMARI VIPPOLA¹, ANU KEMPPAINEN², PEKKA SIITONEN³, VELI-TAPANI KUOKKALA¹

¹Tampere University of Technology, Tampere Wear Center, Department of Materials Science, P.O.Box 589, FI-33101 Tampere

²SSAB Europe Oy, P.O.Box 93, FI-92101 Raahе, Finland

³Metso Minerals Oy, P.O.Box 306, FI-33101 Tampere, Finland

*corresponding author: vilma.ratia@tut.fi

ABSTRACT

Especially in tunneling, the abrasiveness of rock is an important property, which can easily be determined by several methods developed for the purpose. With this in mind, it is rather surprising that the effects of different rock types on the wear mechanisms of engineering materials have not been too widely studied. In this paper, high stress three-body abrasive tests were conducted with four different abrasives with a relatively large (2-10 mm) particle size. As test materials, three different steels and three hard metals were used. The tests clearly showed that material type has an influence on how different abrasive and material properties affect the abrasive wear mechanisms and severity. For example with hard metals, the most important property of the abrasives is their crushability, as only small abrasive particles are able to properly attack the binder phase and cause high wear rates. On the other hand, it seems that the abrasiveness of rock is not the dominating property determining the severity of wear in the current test conditions for any of the tested materials. In fact, with steels no single abrasive property could be shown to clearly govern the abrasive wear processes. In any case, when using the determined abrasiveness values in wear estimations, the contact conditions in the method used for determining the abrasiveness values should be as similar as possible with the end application.

INTRODUCTION

Abrasive wear occurs widely in everyday life in both households and industry. The estimated annual cost of abrasive wear is 1-4 % of the GNP of the industrialized countries [1]. From the economical point of view, it has been estimated that in engineering abrasive wear is probably the most crucial type of wear [2].

A common way to study abrasive wear is to use the standard ASTM G65 dry sand rubber wheel test. However, the correlation of its conditions with real applications is not always

clear. For example, when screening materials for mineral crushing applications, Ala-Kleme et al. [3] concluded that the correspondence of the rubber wheel results with the field test results was very poor.

Since the conditions play an essential role in the wear processes, application-tailored wear tests have been of increasing interest in the industry. In order to obtain results, which are closely related to the application, one should try to simulate the true conditions as well as possible. In abrasive wear testing, a good way of increasing the degree of reality is to use abrasives that are likely to be present in the

intended application. Natural stones are therefore a good choice for abrasives when testing materials for earth moving and mining machinery.

Abrasive wear is a complex phenomenon and there are many variables to be taken into account, such as the wear environment, the type of motion, and the contact forces. Changing one variable can change the outcome of the tests substantially.

An essential variable in abrasive wear is the abrasive itself and its properties. The abrasive is in a big role largely determining the mechanisms with which the wear is happening. The effects of size [4–7] and shape of the abrasives [8–11] on wear have been discussed by several authors. The same abrasive properties may have different effects when conditions change, for example, from impacts to abrasion [12]. On the other hand, different wear mechanisms can be observed in systems where the conditions are similar and only the abrasive type is varied [12–14].

The abrasiveness of rock and soil and the methods of measuring it have been discussed widely in geology and tunneling [15–22]. Some methods used for determining the abrasiveness of rock are thin section analysis, Cerchar test, LCPC test, Schimazek index test, Sievers C-value test, Böhme grinding test [18], the brittleness value test, Sievers J-value test, and abrasion value and abrasion value cutter steel test [21]. The Cerchar abrasivity test is widely used for TBM tunneling and also for academic purposes [19,23]. On the other hand, it tests the properties of individual grains or blocks only [18] and is affected by the stress state of the rock [23]. The LCPC test is an abrasiveness test that enables the investigation of rock samples consisting of several grains with various sizes, and it has been reported to be one of the most used methods for determining the abrasiveness of rock materials in Europe [18].

There are only a limited number of papers, which take into consideration the properties of real rock materials in high stress abrasive wear conditions. Some researchers have investigated abrasive wear with larger size abrasives in impacting conditions [13,24–26]. On the other hand, in the abrasive wear tests, the particle size has often been restricted to less than a millimeter [4,5,12,26,27] even in the studies determining the size effect of abrasives or natural stones on wear.

The aims of this study are to compare different Finnish rock species and the wear type they produce in some typical mining and earth moving machinery materials under controlled compressive crushing conditions, and to find correlations between the rock properties and wear performance of selected steels and hard metals.

MATERIALS AND METHODS

Several different steel and WC-Co specimens were tested using the crushing pin-on-disc wear test procedure. Four different rock species were used as abrasives.

Metals and hard metals

The abrasive wear resistance of three steel and three hard metal grades were evaluated. Table 1 lists the steels along with their nominal mechanical properties and compositions. One of the steels was the commonly used structural steel grade S355 with a ferritic-pearlitic microstructure, and the two other steels were quenched wear resistant martensitic steels with different hardness, denoted as 400HB and 500HB according to their commercial hardness grade. Besides steels, three hard metal grades were also tested. Table 2 presents the hardness and nominal compositions of the hard metals. They all consisted of tungsten carbides (average carbide size 2.5 μm) with different amounts of cobalt as the binder phase.

Table 1. Nominal mechanical properties and compositions of the tested steels.

Material	S355	400HB	500HB
Hardness [HV]	172	423	505
Yield strength [N/mm ²]	355	1000	1250
Tensile strength [N/mm ²]	470-630	1250	1600
A5 [%]	20	10	8
Density [g/cm ³]	7.88	7.85	7.85
C [max%]	0.18	0.23	0.3
Si [max%]	0.5	0.8	0.8
Mn [max%]	1.6	1.7	1.7
P [max%]	0.025	0.025	0.025
S [max%]	0.02	0.015	0.015
Nb [max%]	0.05	-	-
Cr [max%]	-	1.5	1.5
Ni [max%]	-	1	1
Mo [max%]	-	0.5	0.5
B [max%]	-	0.005	0.005

Table 2. Hardness, density and nominal compositions of the tested hard metals.

Material	Hardness [HV]	Density [g/cm ³]	Composition [wt.-%]	
			WC	Co
WC-26Co	870	13.02	74	26
WC-20Co	1050	13.44	80	20
WC-15Co	1260	13.99	85	15

Abrasives

Table 3 lists the properties and nominal mineral contents of the used abrasives. As the abrasives are natural stones, their properties can vary locally and should be regarded only as approximates. The density, uniaxial compressive strength (UCS), and quartz content were obtained from the supplier of the rocks. The abrasiveness and crushability values were determined using the LCPC test, which is described in the French standard NF P18-579. The tests were conducted in the Metso Minerals Rock Laboratory in Tampere. The LCPC test gives the LCPC abrasion coefficient (LAC) and the LCPC breakability coefficient (LBC). In the test, a standardized steel block with hardness of 60-75 HRB is rotated in a 500 g batch of 4-6.3 mm rock in a container for 5 minutes [15]. The abrasiveness (LAC) is determined from the mass loss of the steel block and the crushability (LBC) from the rock sieving results using the following equations [19]:

$$LAC = \frac{m_0 - m}{M} \quad (1)$$

$$LBC = \frac{M_{1.6} \cdot 100}{M} \quad (2)$$

where m_0 and m are the steel block's mass before and after the test, respectively. M is the mass of the abrasive (500 g, i.e., 0.0005 t) and $M_{1.6}$ is the mass of the <1.6 mm fraction of the abrasives after the test.

The hardness values of the rocks were measured with Duramin A300 hardness tester. Several indentations were made, and the final average hardness was calculated by taking into account the relative fractions of the different phases and their hardness in the rock. The mineral compositions were determined with X-ray-diffraction.

Table 3. Properties and nominal mineral contents of the used abrasives.

Rock species	Tonalite	Granite	Gneiss	Quartzite
Abbreviation	T	GR	GN	Q
Quarry	Koskenkylä	Sorila, Tampere	Lakalaiva, Tampere	Nilsä, Haluna
Density (kg/m ³)	2660	2674	2747	2600
Uniaxial compressive strength (MPa)	308	194	64	90
Hardness (HV1)	960	800	700	1200
Quartz content (wt%)	40	25	24	98
Abrasiveness (g/t)	1460	1920	1430	1840
Crushability (%)	18	34	37	74
Nominal mineral contents (%)	quartz (40) plagioclase (40) biotite (17) amphibole (3)	plagioclase (45) quartz (25) orthoclase (13) biotite (10) amphibole (5)	plagioclase (36) biotite (25) quartz (24) orthoclase (7) amphibole (5) garnet(3)	quartz (98) sericite hematite

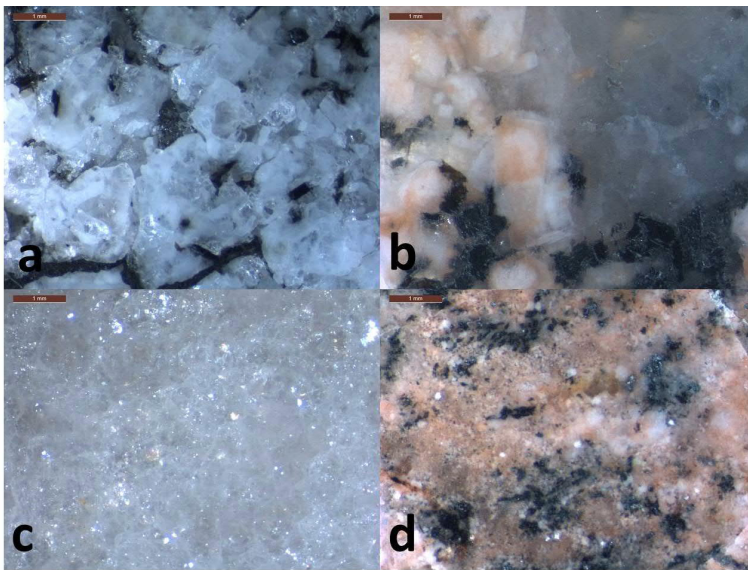

Figure 1. Images of the polished rock specimens used for wear testing a) gneiss, b) granite, c) quartzite and d) tonalite. Scale bar is 1 mm.

Figure 1 presents optical stereo microscope images of the polished surfaces of the abrasives. It can be observed that granite (1b) and gneiss (1a) have a similar and quite coarse grain structure. Tonalite (1d) consists of quite small size grains, and quartzite (1c) has the finest grain structure of the studied abrasives.

Figure 2 illustrates the appearance of the abrasive particles, revealing also the evident differences in their morphology. Gneiss (2a) has a quite heterogeneous structure including spherical, longitudinal and also flaky particles. Tonalite particles (2d), in turn, are quite round. Granite (2b) and quartzite particles (2c) have a quite similar morphology, consisting mainly of angular particles.

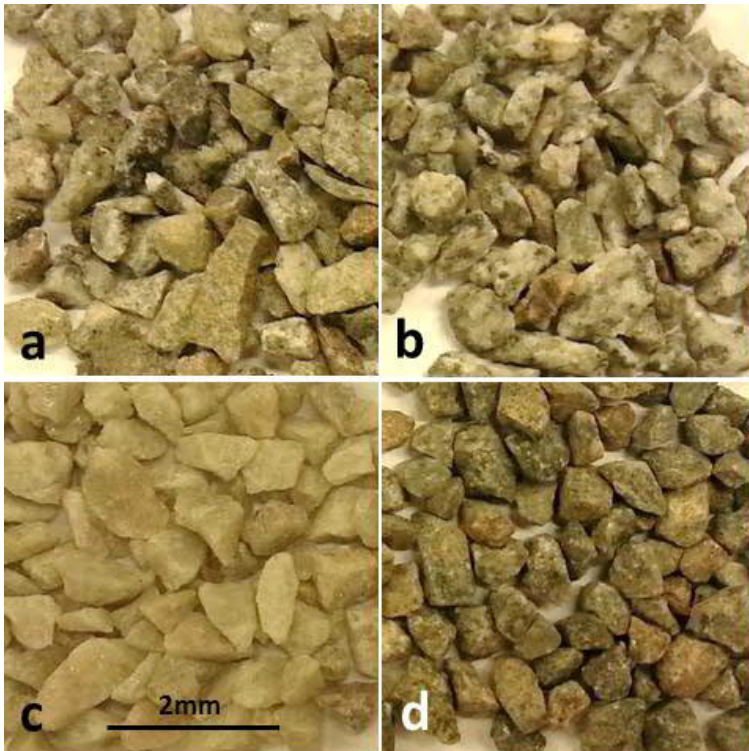

Figure 2. Images of the abrasive particles used for wear testing a) gneiss, b) granite, c) quartzite and d) tonalite.

Crushing pin-on-disc abrasive wear testing

The wear tests were conducted with a crushing pin-on-disc [14], which is a three-body high stress abrasive wear tester. It has a setup similar to the common pin-on-disc equipment, but it enables addition of 500 g of 2-10 mm abrasive between the pin and the disc. This helps to simulate heavy abrasive conditions better than, for example, the dry sand rubber wheel abrasion tester, where the size of the abrasive is 212-300 μm [28]. Figure 3 presents schematically the principle of the equipment.

Unlike in the common pin-on-disc setup, in the crushing pin-on-disc the pin and the disc are not in contact with each other during the test, and thus the wear is induced purely by the abrasives. In the test, the pin is pressed against the abrasive bed on the rotating disc with a force of 240 N for 5 seconds, followed by an idle time for the abrasive to replenish between the pin and the disc. The abrasive is maintained on the disc with a collar. The disc material was structural steel S355 (216 HV) for the steel samples and tool steel (690 HV) for the hard metal specimens.

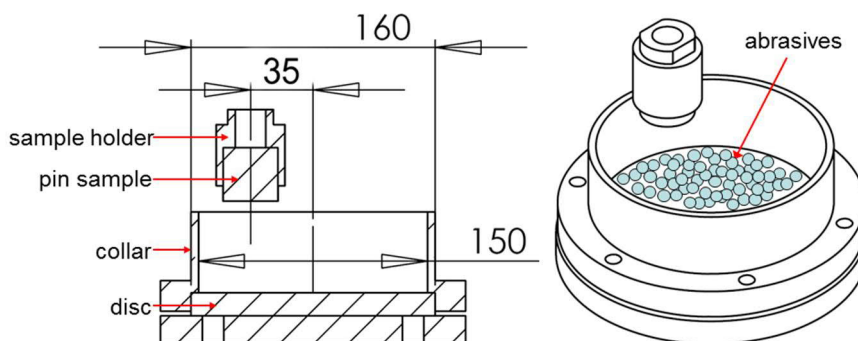

Figure 3. Schematic picture of the crushing pin-on-disc wear testing equipment.

Before the actual tests, the steel specimens were first subjected to a run-in period of 15 minutes, during which the steady-state wear was achieved. Also, in this way the effect of the embedded abrasive fragments on the mass loss was minimized. The total contact time when the pin was pressed against the abrasives was 20 minutes in each test. The wear was measured as mass loss, which was then converted to volume loss to enable better comparison of the wear in materials with different densities. Three repetitive tests were made on each specimen type.

After wear testing, the wear surfaces were characterized with Leica MZ 7.5 optical stereo microscope and Philips XL30 scanning electron microscope. Moreover, Wyko NT1100 optical profilometer was used to determine the wear surface profiles and to obtain numerical data of the roughness of the surface.

RESULTS

In this Chapter, the volume loss results are presented in relation to the properties of the abrasives. Also observations on the wear

surfaces and the abrasive sieving results are presented and discussed.

Volume loss results

Higher hardness is generally known to enhance the abrasive wear resistance of materials, which was also clear in the current tests. Figure 4 presents the volume loss results from the tests with different abrasives in relation to the hardness of the test materials. Figure 4a shows that for the steels (hardness 172-505 HV) the trend is very clear, while for hard metals (Figure 4b) the correlation is less pronounced. The role of the abrasive type is clearest with hard metals tested with quartzite, the results being distinctly different from the results obtained for hard metals with the other abrasives. Also in steel specimens quartzite produces relatively more wear in the hardest alloy, but in the case of softer steels granite and gneiss clearly rise above it. This may result from the formation of an embedded quartzite powder layer on the softer materials, protecting the surface from being penetrated with larger size abrasives thus decreasing the wear rate [29].

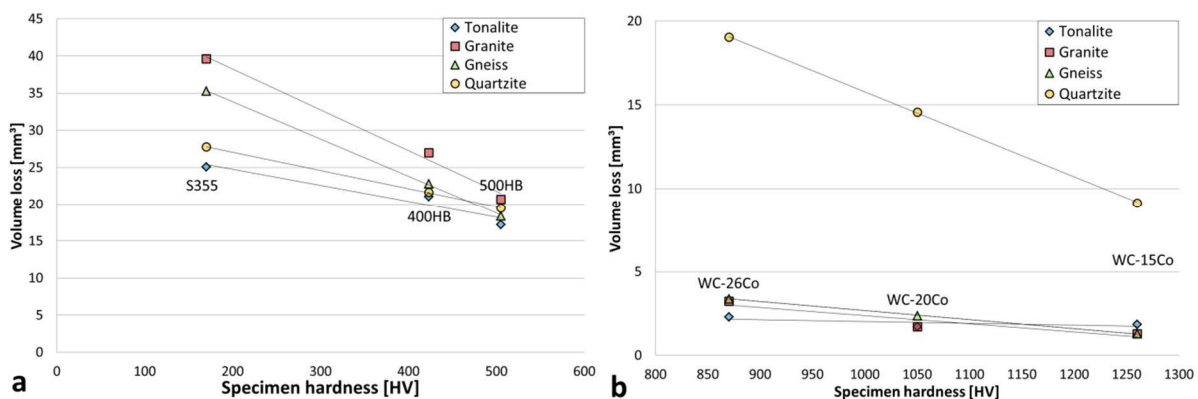

Figure 4. Volume loss of a) steel and b) hard metal specimens relative to their hardness.

Besides the volume loss of the pin, also the volume loss of the disc was monitored. For steels, the disc volume loss decreased as the pin hardness increased. This is probably because on harder materials the abrasive is more likely to pass the surface without embedding in it, and there is also less friction in the system.

Even though the pin and the disc are not in direct contact with each other during the test, the disc as the test counterpart has an effect on the moving of the abrasive in a three-body abrasion system [14,30,31]. The abrasive can move differently depending on whether the counterpart is softer or harder than the wearing part. For the tested steels, the pin/disc hardness ratio ranged from 0.8 to 2.3, while with the hard metals the ratio was 1.3-1.8. For both types of materials, the wear rate decreased as the ratio of the hardness of the pin and the disc increased, although no uniform dependence for both materials was found. It must also be kept in mind that in general the higher hardness of the specimen (pin) resulted in lower wear.

As there were distinct differences between the wear caused by different abrasives, the volume loss results were analyzed in view of the properties of the abrasives in order to find out, how they correlate with the wear test results and which properties have the largest effect. Figure 5 presents the wear results in relation to the crushability of the abrasives. It shows that there is a clear correlation between the wear of hard metals and the crushability of the abrasives, i.e., the amount of wear increases with increasing crushability. Moreover, the difference between the WC-Co grades is substantially larger when tested with quartzite compared to the other abrasives. For the steels, on the other hand, no such unambiguous trend can be observed. It is also worth noting that while the crushability seems to correlate with the wear rate of hard metals, for the uniaxial compressive strength (UCS) no such trend could be observed. This implies that while the uniaxial compressive strength is a measure of the overall rock strength,

crushability is only a measure of the rock's ability to produce fine size particles during crushing.

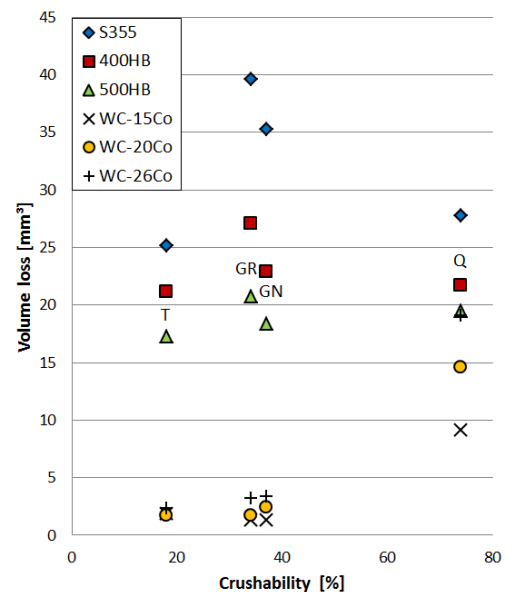

Figure 5. Volume loss of specimens in relation to the crushability of the abrasives.

Figure 6 presents the volume losses in relation to the abrasiveness of the abrasives. It is interesting to note that no clear linear correlation can be observed for either of the material groups. For example for steels, the abrasive with the highest abrasiveness value produces highest wear, but otherwise the results show only considerable scatter. This suggests that the contact conditions affect the abrasion process considerably and that the abrasiveness values determined with the LCPC test do not comply with the contact conditions prevalent in the crushing pin-on-disc test.

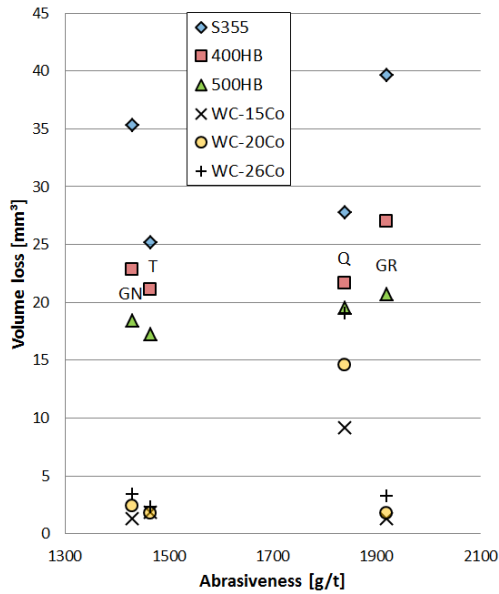

Figure 6. The volume loss of specimens in relation to the abrasiveness of the abrasives.

As hardness in any case plays a major role in the abrasive wear of materials and affects the choice of mechanisms by which it primarily happens, it is worthwhile to study also the effect of the hardness ratio of the test material and the abrasive on the wear process. It is generally taken that for a scratch to form the material hardness must be 80% or less of the abrasive hardness [32,33]. Figure 7 presents the volume loss as a function of the hardness ratio of the test materials and the abrasives. The trend is clear, showing that the higher is the hardness ratio, the lower is the wear rate. The value above which excess hardness does not anymore provide additional benefit seems to be around 0.9-1.1.

Abrasive sieving

Figure 8 presents the average sieving results of the abrasives after the tests with steels. The results are in good agreement with the crushability results presented in Table 3, where quartzite has a clearly higher and tonalite clearly lower crushability than granite

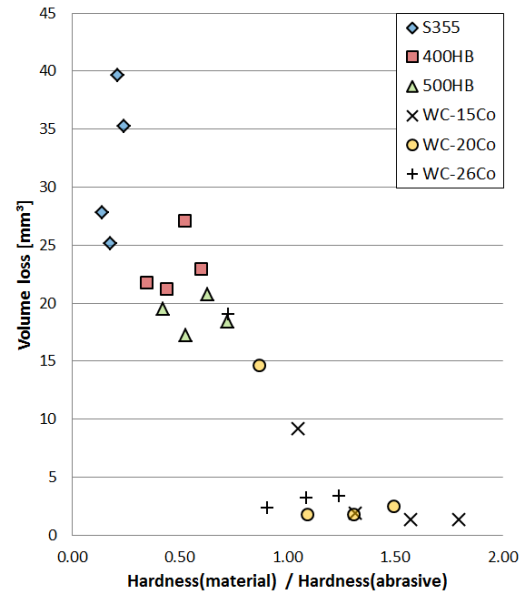

Figure 7. Volume loss dependence on the hardness ratio of the test material and the abrasive.

and gneiss, which again are very close to each other. The LBC crushability values show the percentage of particles smaller than 1.6 mm after the LCPC test. A direct comparison between the crushability and the sieving results after the crushing pin-on-disc cannot be made due to different initial size distribution and test time. However, an approximate assumption can be made by comparing the crushability value with the percentage of particles smaller than 2 mm after the crushing pin-on-disc. These percentage values are presented in Figure 8 above the sieving results. The values are overall higher than the crushability results of the LCPC test, which is to be expected because of the crushing motion during the test, along with the longer test duration. However, the observations about the effect of crushability on wear remain similar when using either LCPC or application-specific crushability values.

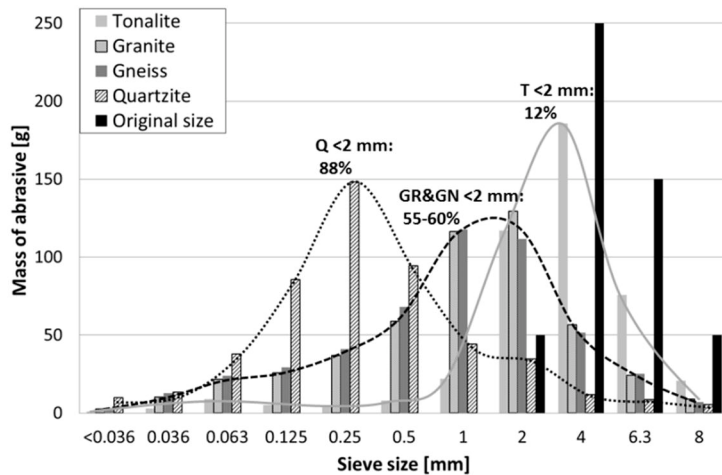

Figure 8. The average sieving results of the used abrasives after the tests with steels and the percentage of particles smaller than 2 mm. Also the original size distribution is shown.

Microscopy

The appearance of wear surfaces was investigated with a scanning electron microscope (SEM). Figure 9 presents the SEM images of 500HB specimens, where clear differences between the wear caused by different abrasive types can be observed. The specimen tested with granite (Figure 9b) contains wider and longer scratches compared to the specimen tested with gneiss (Figure 9a). Although granite and gneiss have approximately the same crushability and quartz content, their UCS are distinctly different, granite having values of about 194 MPa and gneiss about 64 MPa. As higher UCS transmits more effectively the crushing forces to the specimen, this leads to higher degree of deformation on the surface.

The specimen tested with quartzite (Figure 9c) shows the shortest and seemingly shallowest scratches. This is evidently associated with the high crushability value of quartzite, which means that quartzite breaks easily under high stress creating lots of small particles. This is also seen as the larger amount of very fine abrasive powder embedded on the surface, appearing as darker regions in the backscatter electron image.

Figure 9d shows the surface tested with tonalite, containing the highest amount of large scratches. The long scratches stem from the low crushability value of the mineral, enabling the particles to remain intact longer and thus to produce longer scratches.

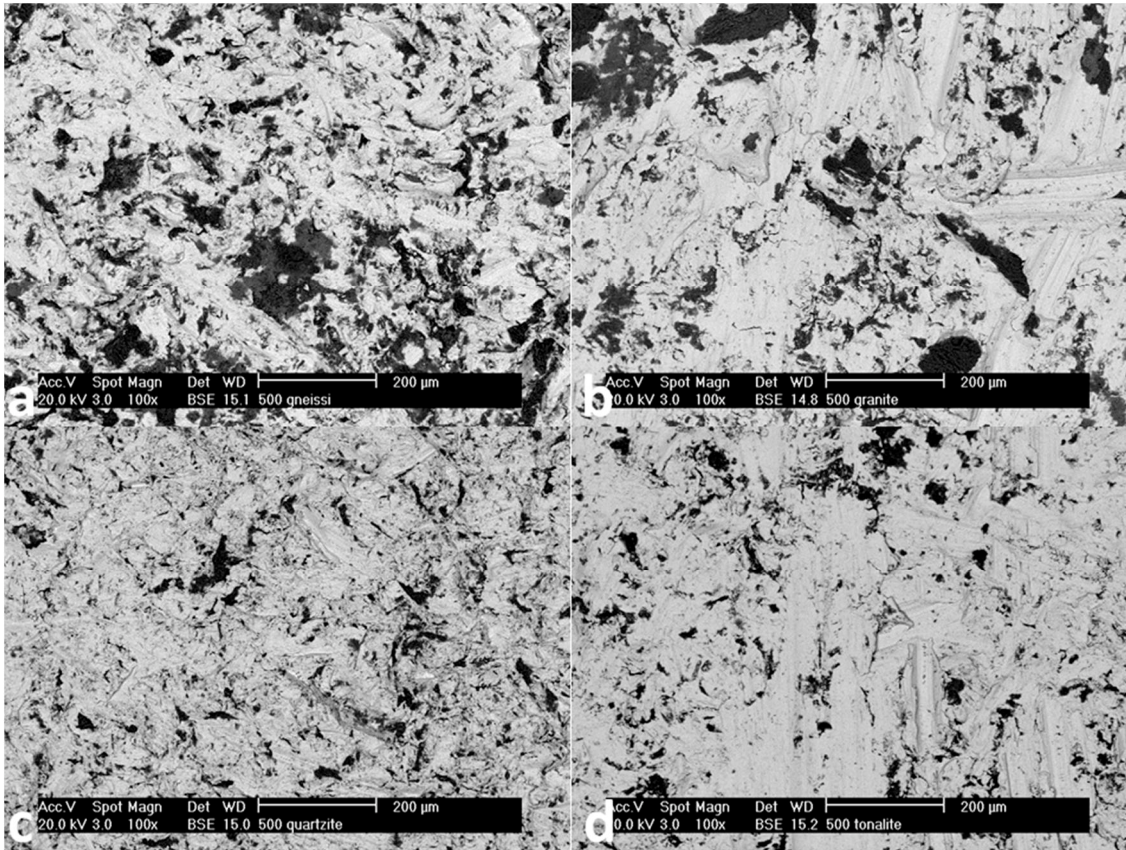

Figure 9. Backscatter scanning electron microscope image of 500HB steel tested with a) gneiss, b) granite, c) quartzite and d) tonalite. The metal is seen as light and the abrasives as dark areas.

Figure 10 shows the wear surfaces of the WC-Co specimens containing 26wt% of the soft binder phase, which is the reason for the relatively low hardness of the material. Although quartzite produced the highest wear rates in the hard metal specimens, the actual wear surface in Figure 10c has the least worn appearance. There are some scratches visible, but they are shorter and narrower than with the other abrasives. Gneiss (Figure 10a) has produced quite wide but shallow scratches, as could be expected due to the flakiness of the abrasive particles. Granite (Figure 10b), in

turn, has produced much deeper scratches than gneiss, but otherwise the wear surfaces look quite similar. The scratches produced by tonalite (Figure 10d) are long but quite narrow, and the harshness of the wear surface is lowest of all abraded WC-Co samples. Tonalite has a quite high compressive strength, and therefore it is able to scratch the surface longer before any fracture of the rock appears. Due to the bluntness of the tonalite particles, they are not able to produce deep scratches.

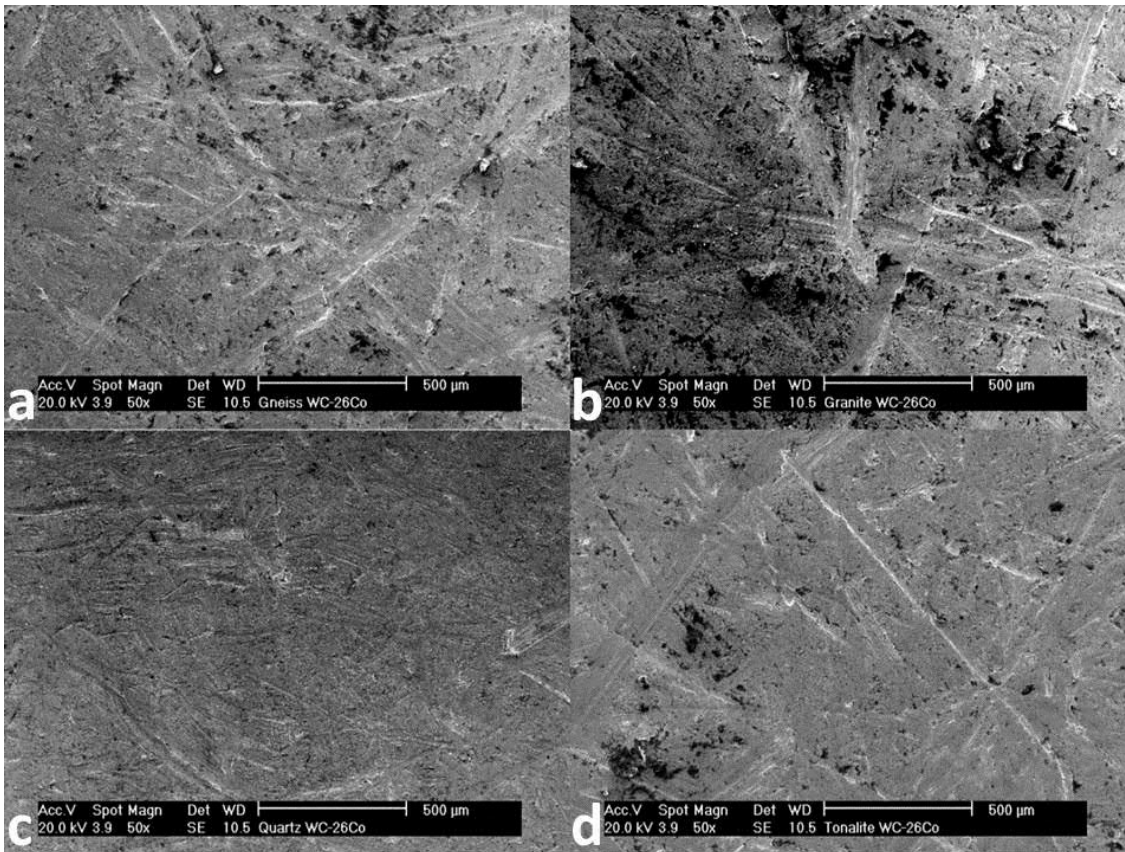

Figure 10. Scanning electron microscope images of WC-26Co hard metal tested with a) gneiss, b) granite, c) quartzite and d) tonalite.

Figure 11 gives a closer look at the wear surfaces of the WC-Co specimens. In all specimens, the carbides appear to be protruding from the surface, indicating that the binder matrix has worn more severely than the carbides. Also crushed carbides were found on every wear surface. The surfaces abraded with gneiss and granite look quite

similar with more local binder phase removal than with quartzite, where the binder phase removal seems to be more general. With quartzite also the amount of crushed carbides appears to be higher, while tonalite seems to be producing the least amount of crushed particles. Re-embedding of crushed carbides was also observed on the wear surfaces.

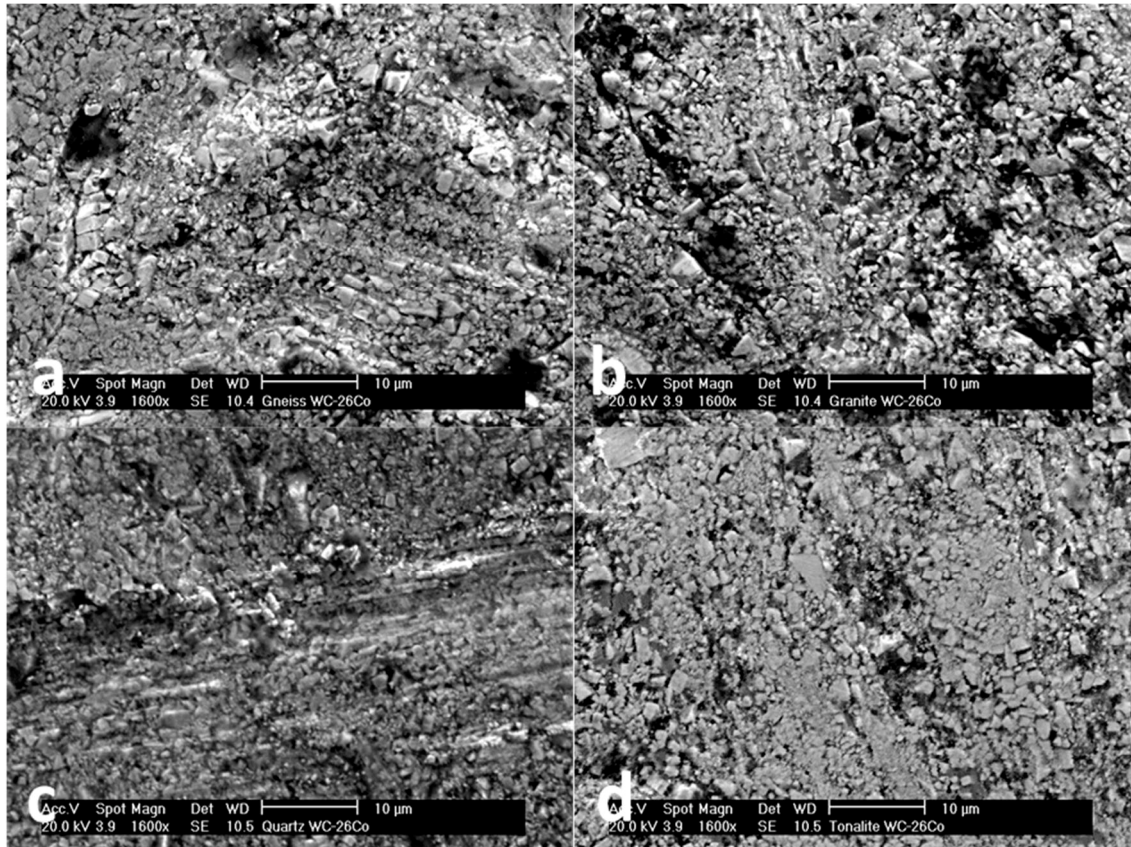

Figure 11. Higher magnification scanning electron microscope images of WC-26Co hard metal tested with a) gneiss, b) granite, c) quartzite and d) tonalite.

In addition to the SEM studies, also the surface roughness Ra values of the pin specimens were measured. As expected, the surface roughness was clearly smaller in the harder materials, but there were no distinct trends or differences observed between the different rock types.

The flat appearance of the steel surfaces observed with microscopy in specimens tested with quartzite could not be verified with optical profilometry. In fact, for the 500HB steel the surface roughness of quartzite worn specimens was to some extent higher than for the specimens tested with the other abrasives. This may be explained by the increased cutting caused by the presence of a large number of small and freshly ground sharp and very hard particles on the wear surface.

In the hard metals, quartzite produced clearly the roughest surfaces, as could be expected based on the volume loss results. On the whole, the Ra values of hard metals followed quite well the crushability values, the second roughest surface being produced by gneiss and tonalite leading to the smoothest surfaces.

DISCUSSION

In the current tests, quartzite produced wear in the studied materials in a clearly different manner than all the other tested abrasives. For steels, quartzite was relatively less abrasive than granite and gneiss. In hard metals, on the other hand, the wear produced by quartzite was 5-12 times higher than with any other abrasive. While the high bulk hardness enabled the hard metals to resist abrasive wear very well in general, the 500HB steel (505 HV) and the WC-26Co hard metal (870

HV) showed approximately the same mass loss when abraded with quartzite. Quartzite is clearly harder than the other used abrasives, and also its crushability is more than twice as high as that of any other of the investigated abrasives. The reason behind the observed differences in the wear test results regarding both the specimen materials and the used abrasives is likely due to the changes in the wear mechanism with changing material/abrasive combinations.

Hard metals consist of two phases: the carbides as the hard phase, and cobalt as the binder phase. In the current test materials, the binder content varied between 15 and 26 percent. Because the hardness of the cobalt matrix is relatively low (typically 140-210 HV), the bulk hardness of the hard metal decreases considerably with increasing binder phase content (see Table 2). Thus, if the hard abrasive particle is small enough to fit between the carbide particles, it can easily wear off the binder phase, leading to carbide pullout and breakage. This is why the high crushability of quartzite combined with high hardness is a more detrimental property to the hard metals than the high uniaxial compression strength or abrasiveness. As the abrasives are being crushed into smaller particles in a brittle manner, there are always fresh and hard angular particles available, which accelerates wear [9,11]. The same phenomenon has been reported also by Krahkmaliev [34]. Another property highlighting the wear potential of quartzite is its higher hardness in contrast to the other abrasives used in this study.

All of the tested abrasives had a different combination of properties, which made it challenging to study the effect of just one property at a time. Quite interestingly, the high hardness, high UCS, and high quartz content made tonalite only a moderate abrasive. Terva et al. [14], who also conducted tests with granite and tonalite, suggested that the cause for the difference is in the breakage mechanisms of these two rocks: granite fracturing produces sharper

contours that can penetrate the material deeper, thus causing more cutting damage.

On the steel wear surfaces, the differences in the wear behavior were clearly visible. The steels tested with quartzite and gneiss with lower UCS showed distinctly shorter scratches than the ones tested with abrasives with higher UCS. Petrica et al. [13] concluded that in a two-body contact the high-UCS abrasives produce cutting and ploughing, whereas the intermediate UCS abrasives produce more plastic deformation and abrasive grooves. This is in quite good agreement with the current findings, although the contact conditions in the tests were different.

In the high stress three-body abrasive conditions, crushability was found to be the key property of the abrasives in the wear of hard metals because of the wear mechanism based on the attack on the softer binder phase. In steels, a combination of moderate crushability and high enough abrasiveness produced the highest wear. In addition, for steels being relatively homogeneous in microstructure, the ability of the abrasives to transmit load without breaking and to maintain a reasonable portion of them sharp for easy penetration, are also important factors.

Abrasiveness of the rock is an important parameter when planning tunneling or excavations, but on the basis of the current results, attention must also be paid on the types of the materials used in the machinery and on the contact conditions existing on the site. The abrasiveness values are often determined using steels as the test material, like in the widely used Cerchar abrasiveness index or LCPC abrasiveness coefficient measurements. As observed in the current study, the wear behavior of steels and hard metals can be distinctly different when considering the wear mechanisms and the affecting abrasive properties, and therefore the abrasiveness values determined for steels do not necessarily apply to hard metals, which

are used in many tools such as rock drilling buttons. Moreover, the crushability (LBC) values should also be taken into consideration, especially with hard metals.

Another issue is the contact conditions. The abrasiveness value only states that a certain rock type is abrasive in certain type of conditions, and although different abrasiveness values may have a correlation with each other [18,20], their applicability in the situation to be simulated must be carefully assessed. For example in the LCPC abrasiveness test, wear is occurring to a great extent by open two-body abrasion in the edge parts of the blocks, whereas in the current high stress three-body abrasion tests wear mostly occurs in the center part of the specimen as three-body abrasion under the applied external force.

The effects of abrasive properties in the abrasive wear behavior are quite complex to study. There is no single abrasive property that determines the wear rates for both material types tested in this work, i.e., ferritic-pearlitic and martensitic steels and hard metals. It is also possible that the abrasive properties have combined effects on wear, which should be studied in greater details.

CONCLUSIONS

In three body high-stress abrasive wear, the increased crushability of the abrasive increases the wear of hard metals, because it changes the effective wear mechanism: the small and hard particles increase the wear of the soft binder phase between the load-bearing hard phases. On the other hand, in steels with a relatively homogeneous microstructure, no clear correlation between the wear and the studied abrasive properties was found. Thus, the potential of an abrasive type to cause wear depends not only on the abrasive type but also on the wearing material.

The different contact conditions explain the poor correlation between the wear test results obtained in this work and the LCPC abrasiveness values. As a consequence, it is essential that the contact conditions and the whole wear environment are properly taken into account when the effects of rock properties on the wear behavior are being determined. A better estimation of the wear behavior is obtained using test methods that simulate the true in-service conditions, such as high loads, large abrasive size, and the comminution behavior of the abrasive.

ACKNOWLEDGEMENTS

This study was a part of the FIMECC DEMAPP program funded by Tekes and the participating companies. The authors would like to express their gratitude to M.Sc. Ville Viberg for the LCPC results, and Mr. Ari Varttila and Mr. Terho Kaasalainen for constructing and maintaining the wear testing equipment.

REFERENCES

- [1] J. H. Tylczak, "Abrasive wear," in: ASM Handbook Volume 18. Friction, Lubrication, and Wear Technology, ASM International, 1992, pp. 184–190.
- [2] D. Scott, "Wear," in: Industrial tribology - The practical aspects of friction, lubrication and wear, 1983, pp. 12–30.
- [3] S. Ala-Kleme, P. Kivikytö-Reponen, J. Liimatainen, J. Hellman, and S.-P. Hannula, "Abrasive wear properties of tool steel matrix composites in rubber wheel abrasion test and laboratory cone crusher experiments," *Wear* 263 (2007) 180–187.
- [4] I. Sevim and I. B. Eryurek, "Effect of abrasive particle size on wear resistance in steels," *Mater. Des.* 27 (2006) 173–181.

- [5] A. A. Torrance, "The effect of grit size and asperity blunting on abrasive wear," *Wear* 253 (2002) 813–819.
- [6] M. Woldman, E. Van Der Heide, T. Tinga, and M. A. Masen, "The influence of abrasive body dimensions on single asperity wear," *Wear* 301 (2013) 76–81.
- [7] J. J. Coronado and A. Sinatora, "Effect of abrasive size on wear of metallic materials and its relationship with microchips morphology and wear micromechanisms: Part 1," *Wear* 271 (2011) 1794–1803.
- [8] D. A. Kelly and I. M. Hutchings, "A new method for measurement of particle abrasivity," *Wear* 250 (2001) 76–80.
- [9] G. B. Stachowiak and G. W. Stachowiak, "The effects of particle characteristics on three-body abrasive wear," *Wear* 249 (2001) 201–207.
- [10] D. V. De Pellegrin and G. W. Stachowiak, "Sharpness of abrasive particles and surfaces," *Wear* 256 (2004) 614–622.
- [11] G. W. Stachowiak, "Particle angularity and its relationship to abrasive and erosive wear," *Wear* 241 (2000) 214–219.
- [12] M. Petrica, E. Badisch, and T. Peinsitt, "Abrasive wear mechanisms and their relation to rock properties," *Wear* 308 (2013) 86–94.
- [13] M. Petrica, M. Painsi, E. Badisch, and T. Peinsitt, "Wear Mechanisms on Martensitic Steels Generated by Different Rock Types in Two-Body Conditions," *Tribol. Lett.* 53 (2014) 607–616.
- [14] J. Terva, T. Teeri, V.-T. Kuokkala, P. Siitonen, and J. Liimatainen, "Abrasive wear of steel against gravel with different rock–steel combinations," *Wear* 267 (2009) 1821–1831.
- [15] M. Köhler, U. Maidl, and L. Martak, "Abrasiveness and tool wear in shield tunnelling in soil / Abrasivität und Werkzeugverschleiß beim Schildvortrieb im Lockergestein," *Geomech. Tunn.* 4 (2011) 36–54.
- [16] R. Plinninger, H. Käsling, K. Thuro, and G. Spaun, "Testing conditions and geomechanical properties influencing the CERCHAR abrasiveness index (CAI) value," *Int. J. Rock Mech. Min. Sci.* 40 (2003) 259–263.
- [17] R. J. Plinninger and U. Restner, "Abrasiveness Testing, Quo Vadis? – A Commented Overview of Abrasiveness Testing Methods," *Geomech. und Tunnelbau* 1 (2008) 61–70.
- [18] K. Thuro and H. Käsling, "Classification of the abrasiveness of soil and rock," *Geomech. und Tunnelbau* 2 (2009) 179–188.
- [19] H. Käsling and K. Thuro, "Determining rock abrasivity in the laboratory," in: *ISRM International Symposium-EUROCK 2010, 2010*, 4 p.
- [20] R. Fowell and M. A. Bakar, "A review of the Cerchar and LCPC rock abrasivity measurement methods," in: *11th Congress of the International Society for Rock Mechanics, 2007*, pp. 155–160.
- [21] F. Dahl, A. Bruland, P. D. Jakobsen, B. Nilsen, and E. Grøvd, "Classifications of properties influencing the drillability of rocks, based on the NTNU/SINTEF test method," *Tunn. Undergr. Sp. Technol.* 28 (2012) 150–158.
- [22] V. A. Golovanevskiy and R. A. Bearman, "Gouging abrasion test for rock abrasiveness testing," *Int. J. Miner. Process.* 85 (2008) 111–120.
- [23] M. Alber, "Stress dependency of the Cerchar abrasivity index (CAI) and its effects on wear of selected rock cutting tools," *Tunn. Undergr. Sp. Technol.* 23 (2008) 351–359.
- [24] P. Kulu, R. Tarbe, H. Käerdi, and D. Goljandin, "Abrasivity and grindability study of mineral ores," *Wear* 267 (2009) 1832–1837.

- [25] A. Sundström, J. Rendón, and M. Olsson, “Wear behaviour of some low alloyed steels under combined impact/abrasion contact conditions,” *Wear* 250 (2001) 744–754.
- [26] J. Rendón and M. Olsson, “Abrasive wear resistance of some commercial abrasion resistant steels evaluated by laboratory test methods,” *Wear* 267 (2009) 2055–2061.
- [27] M. Woldman, E. Van Der Heide, D. J. Schipper, E. van der Heide, T. Tinga, and M. A. Masen, “Investigating the influence of sand particle properties on abrasive wear behaviour,” *Wear* 294–295 (2012) 419–426.
- [28] “G65-04 Standard Test Method for Measuring Abrasion Using the Dry Sand / Rubber Wheel.” ASTM International, 2010, pp. 1–12.
- [29] M. Yao and N. W. Page, “Influence of comminution products on abrasive wear during high pressure crushing,” *Wear* 242 (2000) 105–113.
- [30] V. Ratia, K. Valtonen, A. Kemppainen, and V.-T. Kuokkala, “High-Stress Abrasion and Impact-Abrasion Testing of Wear Resistant Steels,” *Tribol. Online* 8 (2013) 152–161.
- [31] N. Axén, S. Jacobson, and S. Hogmark, “Influence of hardness of the counterbody in three-body abrasive wear—an overlooked hardness effect,” *Tribol. Int.* 27 (1994) 233–241.
- [32] A. Torrance, “An explanation of the hardness differential needed for abrasion,” *Wear* 68 (1981) 263–266.
- [33] I. M. Hutchings, “Abrasion processes in wear and manufacturing,” *Proc. Inst. Mech. Eng. Part J: J. Eng. Tribol.* 216 (2002) 55–62.
- [34] P. V. Krakhmalev, “Abrasion of ultrafine WC-Co by fine abrasive particles,” *Trans. Nonferrous Met. Soc. China* 17 (2007) 1287–1293.

Publication II

Vuokko Heino, Päivi Kivikytö-Reponen, Minnamari Vippola, Kati Valtonen and Veli-Tapani Kuokkala

Wear reducing effect of embedded quartz abrasives in the crushing pin-on-disc test method

Tribology Online 7(2012) 179-183

©2012 Japanese Society of Tribologists

Reprinted with permission

Wear Reducing Effect of Embedded Quartz Abrasives in Crushing-Pin-on-Disc Procedure

Vuokko Heino^{1)*}, Päivi Kivikytö-Reponen²⁾, Minnamari Vippola¹⁾, Kati Valtonen¹⁾ and Veli-Tapani Kuokkala¹⁾

¹⁾Tampere University of Technology, Department of Materials Science, Tampere Wear Center
P.O. Box 589, FI-33101 Tampere, Finland

²⁾Metso Minerals Inc.

P.O. Box 237, 33101 Tampere, Finland

*Corresponding author: vuokko.heino@tut.fi

(Manuscript received 11 March 2012; accepted 20 June 2012; published 30 September 2012)

(Presented at Technical Session in the International Tribology Conference Hiroshima 2011)

Crushing of minerals involves several wear mechanisms. The mineral medium increases the complexity of the wear process by introducing many new variables. Despite the fact that processing of minerals normally causes wear, the minerals can also in some cases decrease the extent of wear. The comminution products, for example, can decrease the wear rate in abrasive wear during high-pressure grinding. The aim of this work was to study the effect of embedded quartz on abrasive wear of wear resistant steels by using the Crushing Pin-on-Disc device. This device is based on the common pin-on-disc principle with the addition of abrasives as loose particles between the pin and the disc. The wear resistant steel specimens were first subjected to a running-in period. One set of specimens was run-in with quartz and the other set with granite. After all the specimens were tested with granite; the specimens with quartz running-in suffered less wear than the specimens that had been run-in with granite. The reason for this was that quartz had formed an in-situ composite on the surface of the steel specimens during the running-in period. This composite layer is thin but hard and it effectively resists granite abrasive penetration into the surface and thus reduces the wear rate.

Keywords: abrasion, running-in, granite, quartz, pin-on-disc, in-situ composite

1. Introduction

The economic aspects of wear have motivated people all over the world for several decades to study wear-related phenomena. The crushing of minerals involves various types of wear, and the level of wear is greatly influenced by the minerals. Some minerals even have the ability to some extent to protect the surfaces from excessive wear.

In addition to the abrasive, also the type of the material subjected to wear has an influence on the wear mechanism. For example, hard metals and steels have different wear mechanisms [1]. In abrasion WC-Co hard metals are more sensitive to quartz than to granite, while steels are worn more with granite. In addition, Stachowiak et al. [2,3] reported different behavior of quartz in the abrasion process compared to other abrasives. Terva et al. [4] and Yao et al. [5] have concluded that comminution of the abrasives during the process has a significant effect on the wear test results. The comminution is closely related to the crushability of the abrasive.

The present study focuses on the wear reducing effect of embedded quartz abrasives in wear resistant steels. The wear reducing effects of quartz were studied by using the crushing pin-on-disc, which is a non-standard abrasive wear testing device designed and constructed at the Tampere Wear Center.

2. Experimental Methods

The crushing pin-on-disc is based on the common pin-on-disc principle with the addition of abrasives as loose particles [4]. The pin and the disc do not come into a direct contact with each other during the test. The pin is pressed against the rock bed on the rotating disc with a force of 240 N produced by pneumatic cylinder. The disc is rotating at constant velocity of 28 rpm. The abrasive is maintained on the disc with a collar, as shown in Figure 1, which presents the construction of the equipment. During the test the pin is lifted up cyclically to make sure that the amount of abrasive between the pin and the disc is always sufficient. The height of the rock bed on the disc was 30 mm. Diameters of the pin and the disc are 36 mm and 160 mm, respectively.

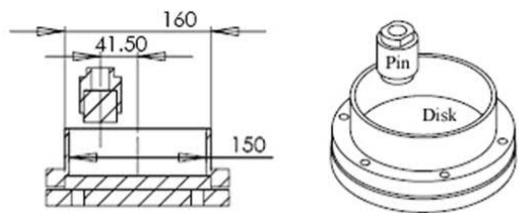

Fig. 1 Illustration of the Crushing Pin-on-Disc wear testing equipment

Two sets of the same grade (480HV10) wear resistant steel specimens, indicating pins, were prepared for the Crushing Pin-on-Disc wear tests. Tensile strength of the pin material was 1550 MPa. The disc was made of structural steel (195HV10). Table 1 lists the test procedures for each sample set. One of the sets was first subjected to running-in with 2-4 mm granite (GR) abrasives for 15 minutes, after which the set (GR+GR) was tested with 2-10 mm granite abrasives for 30 minutes (weighting every 7.5 minutes). The other set was first subjected to running-in with 2-4 mm quartz (Q) abrasives for 15 minutes, after which the set (Q+GR) was tested with 2-10 mm granite abrasives for 30 minutes (weighting every 7.5 minutes). Running-in involves the same testing parameters as in actual test except the size of abrasive is smaller and test time shorter. Each set consisted of three specimens. All the tests were conducted at the room temperature, 20±1°C.

Common minerals, quartz (Q) and granite (GR), were used as abrasives. During the running-in period 500 g

abrasives of size 2-4 mm was used. During the actual tests, 2-10 mm abrasives were used according to Table 2. This size distribution was provided according to our earlier tests and it has been observed to cause quite high wear rate in the specimens. Due to the presence of different size fractions, the abrasive bed of loose particles is densely packed. The initial size distribution was obtained by sieving. Abrasives were also sieved after the tests to obtain their final size distribution and to ensure that the testing conditions were the same for every specimen.

Granite was obtained from Sorila quarry in Finland. Granite consists of quartz, mica and feldspar. Quartz was obtained from Nilsjä quarry in Finland. Quartz contains also some levels of feldspar (below 5 wt%). Quartz is known for its lower compressive strength than granite, and therefore quartz is more easily crushed into a fine powder. Table 3 presents the properties of the abrasives.

The wear surfaces were studied with an optical profilometer Wyko NT1100 by Veeco after the running-in period and after the actual wear test was completed. Moreover, the wear surfaces and specimen cross-sections were characterized with a scanning electron microscope (Zeiss ULTRaplus UHR FEG-SEM). The elemental composition of the cross-sections were also analyzed with EDS (INCAx-act Energy Dispersive X-ray Spectrometer).

Vickers hardness profile measurements were done for the specimen cross-sections after the running-in period and after the wear tests. Micro-hardnesses were also

Table 1 Test procedures for different sample sets

Sample	Running-in (min)	Test (min)	Abrasive size (mm)	Abrasive	Weighting cycle
Q	15		2-4 mm	Quartz	15 min
GR	15		2-4 mm	Granite	15 min
Q+GR	15 min with quartz	30	2-10 mm	Granite	7.5 min
GR+GR	15 min with granite	30	2-10 mm	Granite	7.5 min

Table 2 Initial sieved size distribution of the abrasives for the Crushing Pin-on-Disc tests

Abrasive size (mm)	Mass (g)
8-10	50
6.3-8	150
4-6.3	250
2-4	50
Total	500

Table 3 The properties of the used abrasives

Abrasive	Quartz	Granite
Quarry	Nilsjä, Finland	Sorila, Finland
Hardness (HV1)	1150	1000
Compressive strength (MPa)	90	200

measured from the cross-sections with Anton Paar micro-hardness tester integrated into the Philips XL-30 scanning electron microscope.

3. Results and Discussion

During the running-in period, wear resistant steel specimens suffered 22-48% more weight loss in the GR tests than in the Q tests. It should be noted that variation in the relative weight loss is high in the running-in tests due to the variance in the surface quality of non-tested samples. Figure 2 shows that in the GR+GR tests the specimens suffered 18-23% more weight loss than in the Q+GR tests. It should be also noted that the results obtained after the running-in period (GR and Q) and after the actual tests (GR+GR and Q+GR) cannot be compared directly due to the different duration of tests.

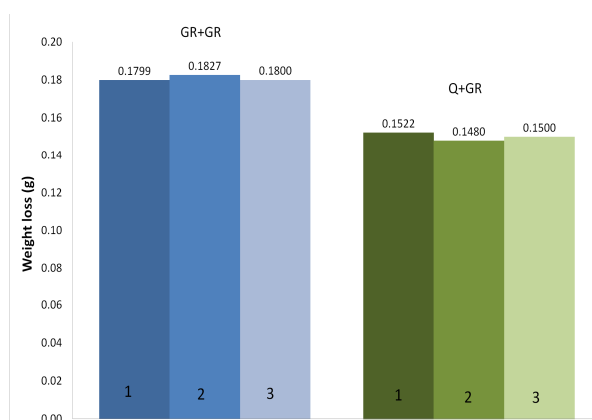

Fig. 2 Weight losses of the individual samples in GR+GR and Q+GR sample sets

Table 4 presents the results of the EDS-analyses in atomic percents. Analyses were taken from the sample cross-sections approximately 2 μm beneath the wear surface. After running-in, constituents from the abrasives were found from the cross-sectional specimens in addition to iron from the base material. After the actual wear test, the amount of abrasive residues on the surfaces of GR+GR tested specimens was lower than in the specimens after the GR test. Mg, Al, Si, K, Ca, Zn and Fe are constituents of mica and feldspar in granite. Q+GR tested specimens had a high amount of quartz present on the surface even after the actual 30 minute wear test with granite. Origin of the high level of Si can be stated to be from quartz running-in while the level of granite constituents (mica, feldspar) is almost negligible in the Q+GR specimens.

Table 4 EDS-analysis results from the near surface region

Sample	Al (at%)	Si (at%)	K (at%)	Ca (at%)	Fe (at%)
Q		71.24			28.76
GR	7.27	18.52	1.49	0.51	72.21
Q+GR	1.67	52.32			46.01
GR+GR	1.15	17.76	0.51	1.03	79.55

Figure 3 presents the wear surfaces after the wear tests as backscattered electron (BE) images. The abrasive containing areas appear dark and the steel areas light gray. After running-in with granite, the wear surface contained more long scratches than the other specimens. In the quartz running-in tested Q specimen, the wear surface was uneven and the scratches were quite short. This behavior can be explained by the differences in the crushability values between these two abrasives. Granite can withstand higher compressive forces than quartz, and therefore granite can cut the surface for longer distances before it breaks.

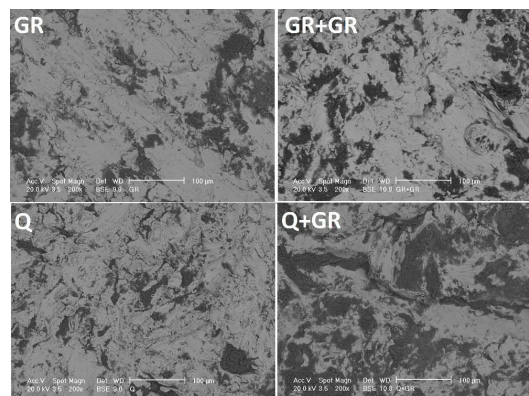

Fig. 3 SEM images from the wear surfaces after the running-in period (left) and after the actual test (right)

After the actual wear test, the wear surface of the GR+GR tested specimen contained long scratches and was heavily deformed. After the Q+GR test, some longer but shallow scratches were visible on the specimen surface, in addition to higher levels of abrasive residues in the surface. Thus, the level of cutting has been lower and abrasives tended to crush into the surface more effectively. This supports the presence of hard top layer on the surface.

Figure 4 reveals, that the comminution of granite particles was similar in the all actual wear tests (Q+GR and GR+GR), as indicated by the more or less identical final size distributions. Low scattering of the sieve analysis results leads to the conclusion that the test conditions have been essentially similar in all wear tests. The comminution during the tests was effective. Only 10% of the particles remained on the 2-10 mm size range, which was the initial size distribution.

During the running-in period quartz is embedded in the surface of the specimen, and high amounts of silicon

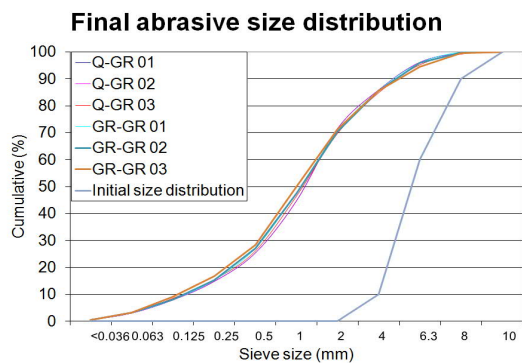

Fig. 4 Cumulative initial and final granite size distributions for all the actual wear tests (Q+GR and GR+GR)

were found on the wear surfaces even after the wear tests with granite. This embedded quartz layer resists the penetration of abrasives during the actual test and results in lower material removal from the surface.

The specimen cross-sections in Figure 5 reveal a highly deformed surface after granite running-in (GR). After the actual wear test, the cross sections reveal a smooth wear surface for the Q+GR tested specimens, whereas in the GR+GR tested specimens the abrasives have been extensively cutting the surface (cutting marks are marked with arrows). This was also indicated by the profilometric studies, which showed that in both Q (median Ra of $4.6 \mu\text{m}$) and Q+GR (median Ra of $5.9 \mu\text{m}$) tested specimens the surface roughness values were lower than in GR (median Ra of $6.2 \mu\text{m}$) and GR+GR (median Ra of $7.1 \mu\text{m}$) tested specimens.

According to the general theory, higher hardness abrasives cause more wear than lower hardness ones [6]. Even though quartz has higher hardness than granite, it still causes less wear than granite in the steel specimens [1]. This can be explained by the lower compressive strength of quartz, which makes it more vulnerable to fracture, leading to decreased wear rates in the steel

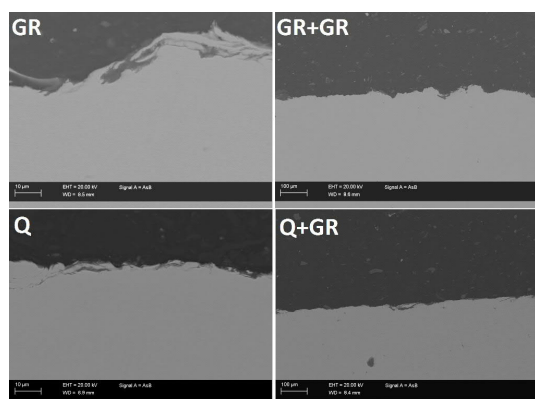

Fig. 5 Cross-sections after the running-in period (left) and after the actual wear tests (right). Scale bar is $10 \mu\text{m}$ on the left and $100 \mu\text{m}$ on the right

specimens. In the case of granite, higher compressive strength allows more effective cutting of the steel surface before fracture occurs. In some cases granite abrasives can also eventually penetrate into the softer disc and cause very high wear rates in the specimens in the form of two-body abrasion. By comparing the wear environments for Q and GR tests, we can conclude that due to the lower compressive strength of quartz, there are much more abrasive contacts per unit area of the wear surface in the Q tests compared to the GR tests. This effect even increases when the abrasive size decreases during the running-in period. In the Q tests the situation becomes closer to comminution than crushing because the abrasive size decreases all the way from 2-4 mm below 0.25 mm during the running-in period, whereas with granite the abrasive size decreases from 2-4 mm only to 1-2 mm. The fine size abrasive particles cover quite effectively the whole wear surface, embed in the surface, and produce lower wear rates in the steel specimens in the further tests with granite (Q+GR). The crushing of quartz into even finer size becomes harder when the abrasive size gets so fine that the number of flaws inside the quartz crystals decreases [7].

The decreased wear rates in the Q+GR tested specimens can be explained by the in-situ quartz-steel composite formed by the fine sized quartz abrasives embedded in the surface of the steel specimens during the running-in period. Figure 6 presents an SEM-image of the layer. The in-situ composite layer is very thin ($1\text{-}3 \mu\text{m}$) but apparently hard and durable.

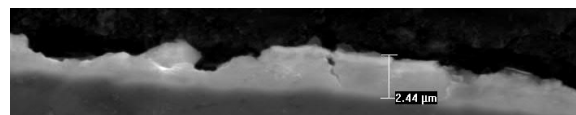

Fig. 6 In-situ composite layer after running-in with quartz

Macro-hardness measurements from the cross-sections showed a similar hardness gradient for all specimens, thus no differences in work hardening levels were observed. SEM integrated microhardness tester was used to obtain information from the hardness of the in-situ composite layer. Any values could not be produced from the indenter marks. It seems evident, however, that the hardness of the in-situ composite layer is higher than that of the material below it. The kite-shaped indenter marks indicate the harder surface layer than the material beneath.

4. Conclusions

In this work, the effect of abrasives on the wear behavior of wear resistant steels was studied. The wear tests were carried out with a crushing pin-on-disc device. One set of the samples was first subjected to running-in with granite and the other set with quartz abrasives after which the both sets were tested with granite abrasives for

30 minutes. The tests showed that running-in with quartz produces an in-situ composite on the surface of the steel specimen that decreases wear by about 20% when compared to specimens that had been run-in with granite. The formed in-situ composite is very durable, as no increase in the wear rate was observed even during the actual wear test with granite.

References

- [1] Ratia, V., "Effect of Abrasive Properties on the Crushing Pin-on-Disc Wear Test Results," Proceedings of 3rd European Conference on Tribology 2011, Vienna, Austria, 2011.
- [2] Stachowiak, G. B., "The Effects of Particle Characteristics on Three-Body Abrasive Wear," *Wear*, 249, 2001, 201-207.
- [3] Stachowiak, G. W., "Particle Angularity and Its Relationship to Abrasive and Erosive Wear," *Wear*, 241, 2000, 214-219.
- [4] Terva, J., "Abrasive Wear of Steel against Gravel with Different Rock-Steel Combinations," *Wear*, 267, 2009, 1821-1831.
- [5] Yao, M., "Influence of Comminution Products on Abrasive Wear during High Pressure Crushing," *Wear*, 242, 2000, 105-113.
- [6] Hutchings, I. M., "Tribology: Friction and Wear of Engineering Materials," Edward Arnold, London, 1992, 273.
- [7] Unland, G., "Handbook of Powder Technology, vol. 12," Elsevier, Amsterdam, 2007, 118-222.

Publication III

Vuokko Heino, Kati Valtonen, Päivi Kivikytö-Reponen, Pekka Siitonen and Veli-Tapani
Kuokkala

Characterization of the effects of embedded quartz layer on wear rates in abrasive wear

Wear 308(2013) 174-179

©2013 Elsevier B. V.

Reprinted with permission



ELSEVIER

Contents lists available at ScienceDirect

Wear

journal homepage: www.elsevier.com/locate/wear

Characterization of the effects of embedded quartz layer on wear rates in abrasive wear



Vuokko Heino ^{a,*}, Kati Valtonen ^a, Päivi Kivikytö-Reponen ^b, Pekka Siitonen ^b, Veli-Tapani Kuokkala ^a

^a Tampere University of Technology, Department of Materials Science, Tampere Wear Center, P.O.Box 589, FI-33101 Tampere, Finland

^b Metso Minerals Inc., P.O.Box 237, FI-33101 Tampere, Finland

ARTICLE INFO

Article history:

Received 5 December 2012

Received in revised form

18 June 2013

Accepted 19 June 2013

Available online 26 June 2013

Keywords:

Abrasion

Wear testing

Steel

Cast iron

Geological materials

ABSTRACT

Understanding how the wear environment and the history of the wear surfaces affect wear and wear rates is extremely important in mineral processing and mining applications. Through this, the lifetime expectations of wear parts can be estimated more precisely in wear environments with constantly changing abrasive media. Certain mineral combinations can increase wear rates extensively compared to some others. The economical effects of unnecessary down-times are significant. In this study, the effects of embedded quartz layer on wear rates were investigated. Hard metals, metal matrix composites, and several types of steels were studied to find differences in their wear behavior. Running-in of the specimens was performed using quartz or granite abrasives to create surfaces with and without embedded quartz. Only granite was used as an abrasive in the actual wear tests. For low-hardness materials (< 400 HV), the quartz running-in increased the wear rates in the actual wear tests, whereas for medium-hardness materials (400–800 HV) the wear rates were decreased. When the hardness of the tested material was higher than the hardness of quartz, the selection of running-in abrasive did not have an effect on the further wear rate. Characteristics of the embedded quartz layers on different substrates were further determined by scanning electron microscopy.

© 2013 Elsevier B.V. All rights reserved.

1. Introduction

Crushing of rocks is a complex phenomenon involving several wear mechanisms. Plenty of variables affect the wear rate, including the abrasive media, hardness and microstructure of the abraded material and applied pressure, for instance. Knowledge of the behavior of the abrasive media under crushing can lead to more precise expected lifetime estimations and thus minimizing the number of unnecessary down-times caused by early failures or replacement of still functioning parts.

In addition to the abrasive, also the type of the material subjected to wear has an influence on the wear mechanism. It has been earlier observed [1] that there is a clear difference in the wear behavior of WC–Co hard metals and wear resistant steels when abraded with granite or quartz gravel. Quartz is abrading WC–Co more than granite, whereas for wear resistant steels the wear rates are higher when the abrasive is granite. In addition, Stachowiak et al. [2,3] reported different behaviors of quartz in the abrasion process compared to other abrasives. Terva et al. [4] and

Yao et al. [5] have concluded that comminution of the abrasives during the process has a significant effect on the wear test results. The comminution is closely related to the crushability of the abrasive.

Quartz is one of the most abundant minerals in earth's crust. It is the main constituent in sand and in many rock species, but it also occurs in the form of sedimentary or metamorphic rock. The basic difference between sedimentary and metamorphic rock is that sedimentary rocks are formed from condensed sand, and with the help of pressure and heat these sedimentary rocks can be turned into metamorphic ones. Thus quartz sand can be first transformed into sandstone, which can then slowly transform to quartzite under right conditions. Sedimentary rocks are found in earth's surface while the metamorphic ones are found deeper underground [6].

Granite is formed deeper underground than the metamorphic rocks and are classified as igneous rocks. They are mainly consisting of quartz and feldspar (30–60%) [6]. Granite is available in various colors (depending on the constituents), grain sizes, texture and mineralogy.

According to the general theory of wear [7], the wear rate in abrasive wear correlates with the abrasive hardness, i.e., increase in abrasive hardness increases the wear rate. In the case of natural

* Corresponding author. Tel.: +358 408490149; fax: +358 3 3115 2330.
E-mail address: vuokko.heino@tut.fi (V. Heino).

minerals, it has been observed [1] that when comparing the wear behavior with granite and quartz abrasives the trend is quite the opposite for steel specimens, i.e., harder quartz is producing less wear than the softer granite. Previously we have conducted some preliminary studies [8] for one grade of wear resistant steel to gather information on the behavior of quartz. It was shown that it is possible to increase the wear resistance of the steel specimen by embedding quartz abrasives in the specimen surface before the actual wear test.

The present study focuses on the effect of the embedded quartz abrasives on the wear rates of various materials, ranging from low hardness structural steels to high hardness hard metals. The changing of wear behavior with hardness and other material properties is discussed. The selected testing method simulates well heavy abrasive processes, such as crushing of rock. The selected abrasives, quartz and granite are typical for the Finnish bedrock. It was observed in this study that the embedment of quartz mainly decreased the wear rate in specimens but it also increased the wear rates in low-hardness specimens. This observation can benefit and support the selection of materials for example in mining and rock excavation, particularly in cases where the handling of both quartz and granite exists.

2. Materials and methods

The effects of embedded quartz were studied by using the crushing pin-on-disc, which is a non-standard abrasive wear testing device designed and constructed at the Tampere Wear Center [4]. In the crushing pin-on-disc device, the pin and the disc do not come into direct contact with each other during the test. The pin is pressed against the rock bed on the disc rotating at 28 rpm with a force of 240 N for five seconds at a time. The wear surface of the pin is approximately 1000 mm². Fig. 1 presents a photograph and a schematic illustration of the equipment. During the test, the pin is lifted up cyclically by a pneumatic cylinder to ensure that the amount of abrasive between the pin and the disc is always sufficient. Depending on the differences in the hardness between the pin and the disc, the ratio of wear caused by rolling and sliding can be altered. A soft disc and a hard pin combination favors two-body abrasion, while a combination of a pin and a disc of equal hardness favors three-body abrasion [1,4].

Seven materials were tested with two different test combinations, which are presented in Table 1. Three tests were made with both combinations for each material. The surface preparation was done in the same manner to all specimens i.e., fine ground to grit size of 1200. The disc was in all cases made of a structural steel

with a hardness of 190 HV. All test materials were subjected to a running-in period of 15 min with quartz or granite as an abrasive. The actual wear tests lasted for 30 min and were done only with granite as an abrasive. In the actual wear tests the specimens were weighted every 7.5 min. The weight losses were further converted to volume losses for better comparability of the severity of wear within different density materials.

Granite rocks were obtained from Sorila quarry in Finland. The main minerals generally in granite are quartz, mica and feldspar. Characteristic for Sorila granite is the reddish-gray color and a coarse grain size. Quartz was obtained from Haluna quarry in Finland. It is excavated from metamorphic rock (quartzite) and may also contain some levels of feldspar (below 5 wt%). Fig. 2 shows particles of Sorila granite and Haluna quartz with a similar angular shape. Quartz from Haluna has lower compressive strength than Sorila granite, and therefore this quartz is much more easily crushed into a fine powder. The macrohardnesses of quartz and granite were ~1100 HV and ~800 HV, respectively.

During the running-in period, the initial abrasive size used was 2–4 mm. During the actual wear tests, a mixture of 2–10 mm abrasives was used according to Table 2. This very specific size distribution was received when the test parameters were originally evaluated for the crushing pin-on-disc wear testing equipment. Due to different sizes of particles, the abrasive bed of loose particles is densely packed and provides more abrasive contacts with the wear surface and therefore it produces quite high and stable wear rates during the applied crushing procedure. Abrasives were sieved after the tests to obtain their final size distribution and to ensure that the test conditions were the same for every specimen. Comminution behavior is a mineral related property and provides one way to characterize the test conditions.

The tested materials are presented in Table 3 with their characteristic nominal compositions and measured hardnesses. Before wear testing with the crushing pin-on-disc, the macrohardnesses were measured from the surfaces. The wear surfaces and the specimen cross-sections were characterized using a scanning electron microscope (Zeiss ULTRAplus UHR FEG-SEM) equipped with an energy dispersive x-ray spectrometer (INCAx-act EDS).

Table 1

Description of the test combinations. Q refers to quartz and GR to granite.

Test combination	Running-in	Actual test
Q+GR	15 min with quartz	30 min with granite
GR+GR	15 min with granite	30 min with granite

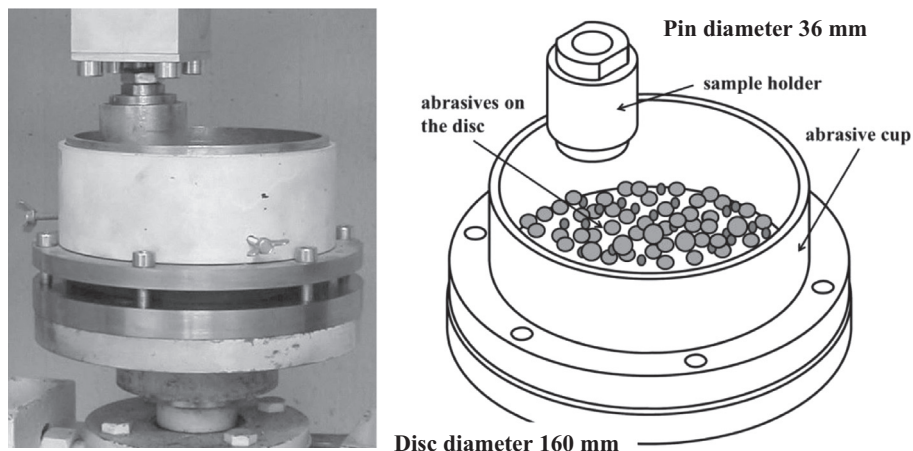

Fig. 1. A photograph and an illustration of the crushing pin-on-disc wear testing equipment.

3. Results

In the crushing pin-on-disc tests, the first step was running-in with granite or quartz abrasives before the actual wear tests with granite. Fig. 3 shows that for the steel specimens granite caused significantly higher volume losses than quartz, which, on the other hand, was the severest abrasive for cast iron, tool steel, metal-matrix composite, and hard metal specimens.

Fig. 4 shows the results of the actual wear tests as average volume losses of three tests with a standard deviation of $\pm 2\%$. The running-in is not included in these results. The low hardness structural steel (S355) showed the highest volume loss with the quartz+granite (Q+GR) combination. In this case, the running-in with quartz clearly increased the wear rate in the actual tests with granite compared to the granite+granite (GR+GR) combination. The difference was over 13% in favor of the Q+GR combination.

Also the softer of the two wear resistant steels (WR1) showed the highest wear rate with the Q+GR combination, which caused over 17% more volume loss than the GR+GR combination. With increasing material hardness, however, the difference in the

volume losses between combinations Q+GR and GR+GR decreased and already for the wear resistant steel (WR2) with a hardness of 480 HV10, the combination GR+GR caused more wear than Q+GR.

The cast iron specimens (CI) showed much higher volume losses with the GR+GR combination than with the Q+GR combination. The difference between these two combinations was as high as 68%, which was the highest measured difference for all tested materials.

The tool steel specimens (TS) showed only a small difference when tested with these two abrasive combinations, showing only 10% less volume loss with the Q+GR combination than with the GR+GR combination. The metal matrix composite (MMC) specimens showed higher volume loss with the GR+GR combination, the difference to the Q+GR combination being about 34%. With



Fig. 2. Stereomicroscope image of Sorila granite (upper) and Haluna quartz particles.

Table 2
Initial abrasive size distribution for the crushing pin-on-disc tests.

Abrasive size (mm)	Mass (g)
8–10	50
6.3–8	150
4–6.3	250
2–4	50
Total	500

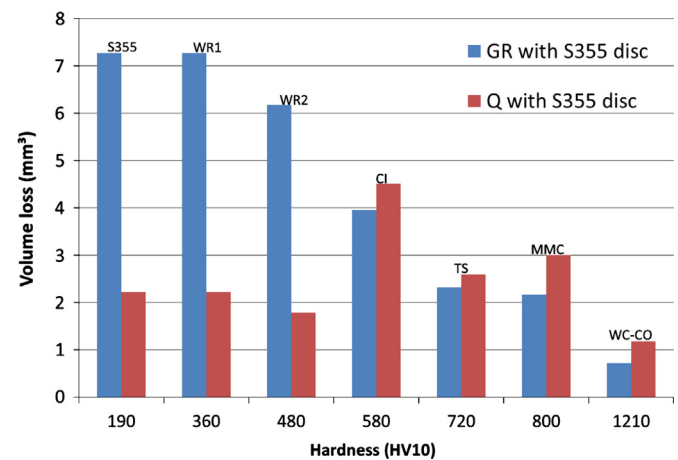

Fig. 3. Results of the running-in procedure with granite and quartz abrasives.

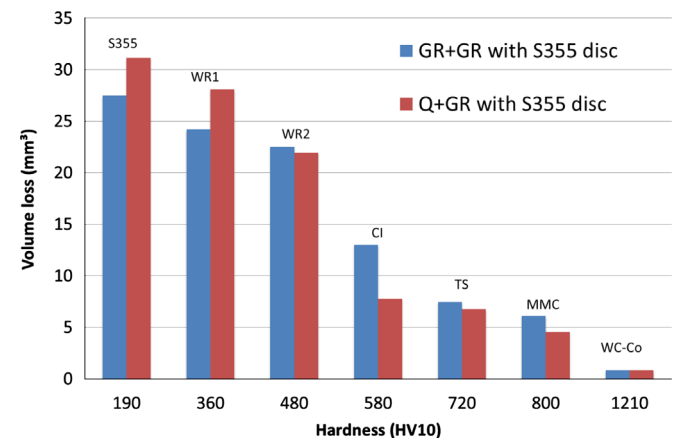

Fig. 4. Results of the crushing pin-on-disc tests with granite after the running-in procedure with quartz or granite.

Table 3
Materials tested with the crushing pin-on-disc method.

Specimen	Material	Nominal composition	Hardness (HV10)
S355	Structural steel	0.18% C, 0.5% Si, 1.6% Mn	190
WR1	Wear resistant steel	0.14% C, 0.7% Si, 1.6% Mn, 0.5% Cr, 0.25% Ni, 0.25% Mo	360
WR2	Wear resistant steel	0.29% C, 0.7% Si, 1.6% Mn, 1.5% Cr, 1.5% Ni, 0.6% Mo	480
CI	Cast iron	3% C, 28% Cr	580
TS	Tool steel	2.9% C, 5.25% Cr, 11.5% V	720
MMC	Metal matrix composite	Recycled and crushed WC-Co (~25 vol%) in the tool steel matrix (1.8% C, 5.25% Cr, 9% V)	800
WC-Co	Hard metal	WC in 15% Co-matrix	1210

further increasing material hardness it was noted that the difference between the two studied abrasive combinations was again decreasing, and for WC–Co hard metals the results were practically identical. Thus, the running-in period had no effect on the volume losses in the actual tests of the hard metal.

Fig. 5 presents the average cumulative volume losses of S355, WR1 and CI specimens with linear trend lines. At the early stages of the tests (at 7.5 min), S355 GR+GR suffered slightly more

volume loss than the S355 Q+GR specimens. Beyond that point, the wear rates in the Q+GR tests of S355 and WR1 increased, when spalling of the quartz-based layer became the dominant mechanism of material removal. After 7.5 min, the wear rates in the GR+GR tests of S355 and WR1 decreased and then stabilized to a constant level till the end of the test. For the CI specimens, the Q+GR combination produced clearly lower wear rates than the GR+GR combination.

All wear surfaces were characterized by SEM. Fig. 6 presents the wear surfaces of CI, MMC and WC–Co after the wear tests as backscattered electron images (BSE). In BSE images, the abrasive areas appear dark, the steel areas gray, and hard metal particles almost white in the tool steel matrix. The images on the right hand side are taken after the test combination Q+GR and the images on the left hand side after the test combination GR+GR.

On the wear surface of the cast iron (CI) specimen tested with the GR+GR combination, wide and long scratches cut by granite abrasives as well as high amounts of abrasive residues are visible. The scratches appear to be quite deep, and their bottoms are clear from abrasive residues. After test with the Q+GR combination, the surface has a much more uniform appearance. Some scratches were detected but they were quite shallow and narrow. The level of abrasive residues was also higher than in the test with the GR+GR combination. This indicates that more crushing of the abrasive rather than cutting had occurred on the surface.

After the GR+GR test, the matrix of the metal matrix composite specimen contained quite high levels of abrasive residues. Some

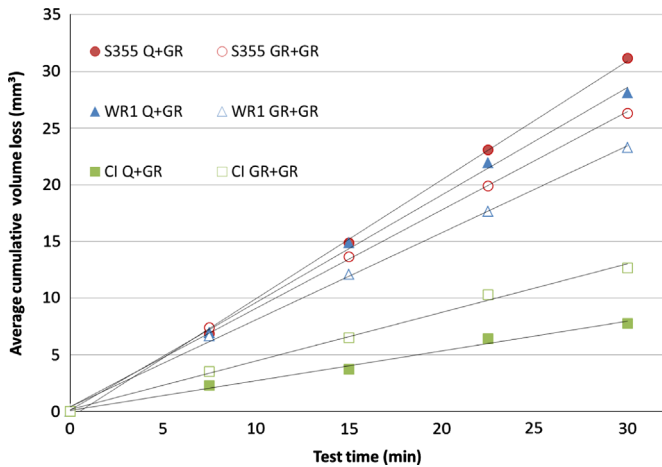

Fig. 5. Average cumulative volume losses of S355, WR1 and CI specimens.

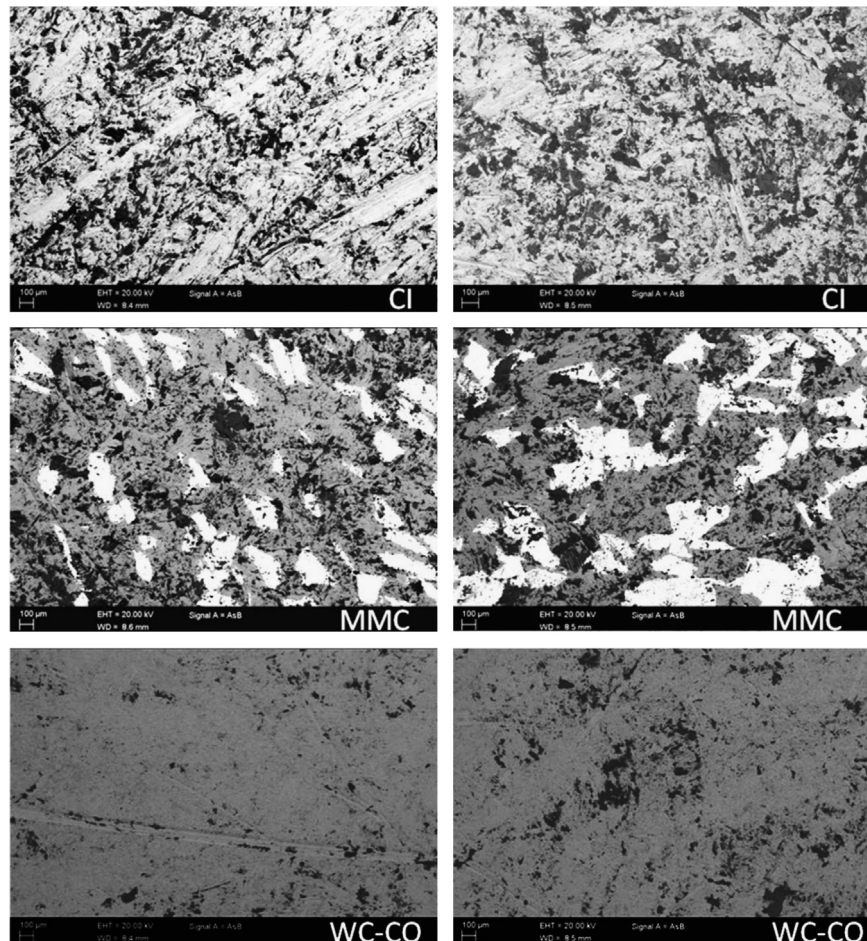

Fig. 6. SEM images of the wear surfaces of CI, MMC and WC–Co specimens after the crushing pin-on-disc tests. Images on the left hand side refer to the combination GR+GR and images on the right hand side to the combination Q+GR.

abrasives were also attached to the hard metal particles. The matrix phase of the specimen appeared to be highly worn, and deep scratches were regularly observed. After test with the Q+GR combination, the concentration of abrasive residues was somewhat higher due to the lower level of cutting. The entire wear surface had a quite uniform appearance and the scratches observed on the surface were mostly shallow.

WC–Co hard metals showed similar volume losses for both test combinations, and also the wear surfaces appeared quite similar. The levels of abrasive residues on the surface were lower compared to the lower hardness materials. However, they were slightly higher after the Q+GR tests even for WC–Co. Most of the material loss was caused by the removal of the binding cobalt phase, which was also every here and there replaced by the abrasive materials.

The EDS analyses of the cross-sections conducted after the actual wear tests showed that high levels of quartz were still present on the wear surfaces of the specimens that showed a lower wear rate with the Q+GR test combination. Although granite also contains quartz, due to its high compressive strength it does not break in these tests and quartz remains in the granite particles. This was also shown by the EDS analyses of the WR2 specimens after running-in with the two different abrasives. Granite did not produce any layers on the specimen surfaces while after running-in with quartz high levels of quartz were found (50–60 wt%) on the surfaces. After the Q+GR test, the level of quartz had decreased but was still notably high (30–50 wt%).

Fig. 7 presents SEM images of the cross-sections of WR1 and CI specimens tested with the Q+GR combination at two different magnifications. Of these two materials, WR1 was worn more with this test combination compared to the GR+GR combination, while CI showed the opposite behavior. The cross-section of the WR1 specimen reveals a heavily worn surface and sections close to delamination, as seen in the upper left corner image of Fig. 7. It can be seen that metal (white) has been removed and transferred from the surface of the sample and mixed with the abrasive material. Between the bulk material and the wear debris layer, there is a lower density layer (light gray), which has been formed by mixing of the bulk material and the quartz abrasives. The appearance of this layer is very fragile, and several cracks can be observed at the interface as seen in the higher magnification image. In the WR1

specimen this layer is thicker (2–4 μm) and therefore much more easily detectable than in the CI specimen. The dark gray areas in the images are granite residues from the actual test. The cross-section of the CI specimen was quite smooth, and there were only some shallow scratches visible. Some sections were again close to delamination, but their number was much smaller than in the case of WR1. In the higher magnification image of the CI specimen, it can be seen that the composite layer is now much thinner, $\sim 1 \mu\text{m}$, because of the harder substrate material that restricts the further penetration of quartz. Also the level of metallic material mixed with the abrasive residues was much lower.

4. Discussion

In mineral crushing, embedded quartz particles may form an in-situ composite with the substrate material and thus affect the further wear resistance of the wear parts. As presented above, the running-in with quartz did not affect all the tested materials in a similar manner. For low hardness steels, such as S355 and WR1, the embedded quartz layers suffered from spalling during the actual tests with granite, thus increasing the total wear rates for the Q+GR combination compared to GR+GR. It was also noted that in the beginning of the Q+GR tests both S355 and WR1 showed similar wear rates, whereas in the GR+GR tests the wear rates were different for these materials throughout the tests. Consequently, the first fifteen minutes in the Q+GR tests were dominated by the wear of the embedded quartz layer. As the embedding depth of the quartz particles depends on the hardness of the tested material, the surface composite layers in S355 and WR1 can become quite thick. Due to the thickness of the layer and the softness of the substrate material beneath it, the surface layer cannot withstand the stresses and abrasive actions during the actual wear tests. Thus, for low-hardness specimens ($< 400 \text{ HV}$) the quartz running-in increased the wear rates in the actual wear tests.

For the materials with 400–800 HV hardness, the wear resistance was improved with quartz running-in due to the formation in-situ quartz–steel composite. In this hardness range, the depth of embedded quartz was lower than in the low-hardness materials, 1–2 μm only, and the steel substrate was hard enough to support

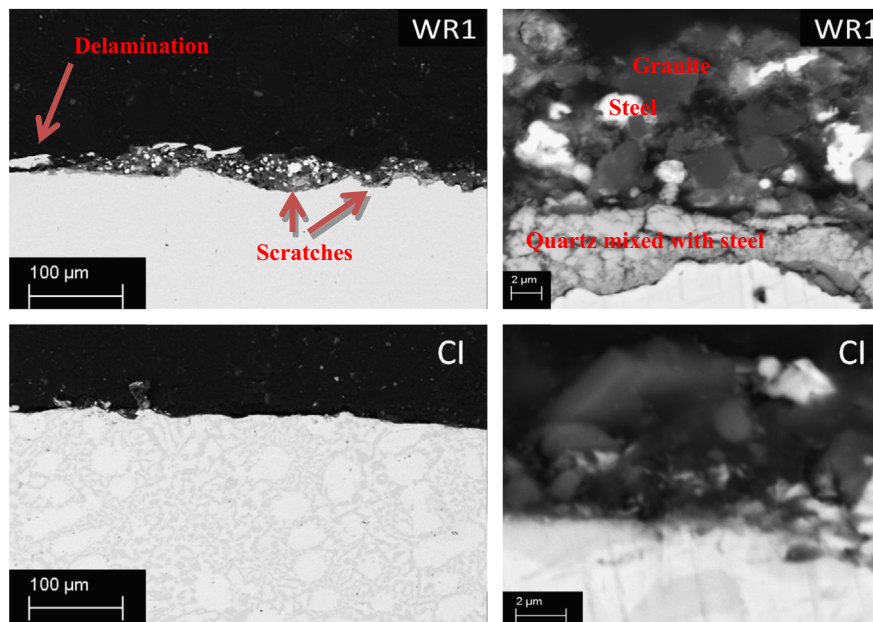

Fig. 7. Cross sectional SEM images of the WR1 (upper) and CI (lower) specimens after the Q+GR test.

the protective layer. This was clearly seen when the cumulative volume losses of the Q+GR and GR+GR tests of these materials were compared. The wear rate and material loss of the cast iron samples were clearly lower during the Q+GR test. In addition, the wear surface after the GR+GR test was rougher and more scratched.

The microstructure of the material also has a marked effect on the formation of the quartz layer. The quartz running-in reduced the wear rate of the harder metal matrix composite more compared to the tool steel. The MMC specimens contain 25 vol% of large fragments of recycled and crushed WC–Co hard metal particles, up to 500 μm in diameter, cemented into the tool steel matrix. The hardness of the hard metal particles is over 1000 HV, but that of the matrix is only 575 HV. Therefore, the quartz particles embedded in the matrix reduced the overall wear of the material in the Q+GR tests.

As the hardness of WC–Co is higher than that of quartz, the penetration of quartz in the samples was found to be negligible. Consequently, running-in with quartz did not have any effect on the results of the actual wear test of WC–Co with granite. However, it should be noted that during running-in quartz caused significantly higher wear rates than granite, as the small particles of quartz abraded the cobalt binder phase more than the larger granite particles. This supports the results of earlier studies [1] with quartz, granite, tonalite, and gneiss, which showed that during crushing of quartz the larger volume of the cobalt phase lead to a higher wear rate of WC–Co hard metal.

5. Conclusions

In this work, the effect of abrasives on the wear behavior of various metallic materials was studied. The wear tests were carried out with a crushing pin-on-disc device. Based on the results of the wear tests and characterization of the wear surfaces, the following conclusions can be presented:

In the crushing pin-on-disc tests, running-in with quartz improves the wear resistance of specimens with initial hardness in the range of 400–800 HV. This is because quartz forms an in-situ composite layer with the substrate material on the surface of the test specimen. This layer is thin but very hard and durable.

Hardness of the material as well as its microstructure has an effect on the formation and stability of the quartz layer. Steels with hardness below 400 HV are not hard/strong enough substrates for this kind of a quartz composite layer, which readily peels off during the subsequent crushing with granite.

The used test method simulates rather well the heavy abrasive wear conditions in mineral handling and crushing. Thus, the obtained results give valuable information to aid material selection for this type of wear conditions. These studies will be continued with scratch tests to determine the differences in the tribological behavior between the quartz and granite wear surfaces.

References

- [1] V. Ratia, V. Heino, K. Valttonen, A. Kemppainen, P. Siitonen, M. Vippola, V.-T. Kuokkala, Effect of abrasive properties on the crushing pin-on-disc wear test results, in: *Proceedings of the 3rd European Conference on Tribology*, Vienna, Austria, June, 7–9, 2011.
- [2] G.W. Stachowiak, Particle angularity and its relationship to abrasive and erosive wear, *Wear* 241 (2000) 214–219.
- [3] G.B. Stachowiak, G.W. Stachowiak, The effects of particle characteristics on three-body abrasive wear, *Wear* 249 (2001) 201–207.
- [4] J. Terva, T. Teeri, V.-T. Kuokkala, P. Siitonen, J. Liimatainen, Abrasive wear of steel against gravel with different rock–steel combinations, *Wear* 267 (2009) 1821–1831.
- [5] M. Yao, N.W. Page, Influence of comminution products on abrasive wear during high pressure crushing, *Wear* 242 (2000) 105–113.
- [6] R. Selley, R. Cocks, R. Plimer, *Encyclopedia of Geology*, Elsevier, The Netherlands, 2005.
- [7] K.H. Zum Gahr, *Microstructure and Wear of Materials*, Elsevier, The Netherlands, 1987, p. 560.
- [8] V. Heino, P. Kivikytö-Reponen, M. Vippola, V.-T. Kuokkala, Wear reducing effect of quartz abrasives in crushing pin-on-disc procedure, *Tribology Online* 7 (3) (2012) 179–183.

Publication IV

Vuokko Heino, Kati Valtonen and Veli-Tapani Kuokkala

Effect of quartzite and granite in wear surfaces on dry sliding

Tribology – Materials, Surfaces and Interfaces 8, 2 (2014) 85-89

©2014 Taylor & Francis Online

Reprinted with permission

Effect of quartzite and granite in wear surfaces on dry sliding

V. Heino*, K. Valtonen and V.-T. Kuokkala

The wear surfaces abraded with quartzite and granite were subjected to scratch tests. Sharp and blunt indenters were used with various constant loads to produce controlled abrasive wear tracks. The characteristics of deformation mechanisms and material removal were further studied using a scanning electron microscope to determine the differences in the tribological behaviour between the quartzite and granite wear surfaces.

The results indicate that quartzite residues are more uniformly distributed as individual particles on the wear surfaces and therefore provide more stable frictional forces. In the case of granite the abrasive residues are rather non-uniformly collected into piles of abrasives.

Keywords: Ball-on-disc, Wear surface, Minerals, Friction

This paper is part of a special issue on the 3rd International Tribology Symposium of the IFToMM: Part II

Introduction

Abrasive wear in industrial processes is still a major cause of failures and down times, and there is a variety of applications suffering from heavy economic losses due to this phenomenon.¹ Basic knowledge of abrasive wear has been available for decades, but there is still lack of knowledge involving application related wear problems that cannot be universally solved. Moreover, the effect of minerals on abrasive wear is not well understood. Increasing knowledge in this area is fundamental to several industries from crusher manufacturers to wear part suppliers. For example in the mineral processing industry there are many affecting variables such as the composition of the minerals involved, the materials used in wear parts, and the direction of the movement of wear surfaces and abrasives in relation to each other. Sometimes a combination of these variables can be more detrimental than any one of the variables as such.

In our previous studies we have concluded that quartzite can form an in-situ composite with certain materials.² This composite can either increase or decrease, depending on the substrate material, the wear rate in the further wear test. Tests were conducted with the crushing pin-on-disc to determine the effect of abrasives on the wear behaviour of various metallic materials. It was noticed that running-in with quartzite, before the actual wear test with granite, improved the wear resistance of specimens with initial hardness in the range of 400–800 HV. This improvement in wear resistance was observed to arise from the formed in-situ composite layer of the substrate material and quartzite. Steels with hardness below 400 HV were not strong enough substrates for this kind of composite layer, and the layer

peeled off during the actual wear tests with granite increasing the weight loss of that sample.

In this study, we have characterised the properties of quartzite and granite abraded wear surfaces. The wear surfaces were produced with the crushing pin-on-disc wear tester. Conical and spherical indenters were used in the scratch tests with loads of 50 and 100 kN. The substrate materials were selected to support and extend our previous studies. In order to make a comparison between the materials in their original state, polished specimens of each material were also tested.

Experimental methods

Four materials with three different surface states were tested with CETR UMT-2 tribometer. The scratch tests were on the granite and quartzite tested wear surfaces, and also for polished unworn surfaces. A Rockwell C diamond tip indenter and a WC-Co hard metal ball were used with constant loads of 50 and 100 N. The Rockwell indenter is a conical stylus with a tip radius of 200 μm , while the WC-Co ball indenter has a radius of 4000 μm . The geometry of mineral abrasives is somewhere between these two indenters. The rotational speed of the tribometer was kept at a constant low value of 0.2 rev min^{-1} to minimise the frictional heating of the specimens. The tests were conducted at room temperature.

The produced circular wear tracks were measured with UBM-Microfocus Compact laser profilometer and characterized with Zeiss ULTRApplus ultra high resolution field emission scanning electron microscope (SEM) equipped with an INCAx-act energy dispersive X-ray spectrometer (EDS). Table 1 lists the test materials. The material selection was based on the results of the earlier tests.²

The materials were tested as received and polished as well as after 15 min wear tests with granite and quartzite as abrasives (2–4 mm). The wear surfaces were produced using the crushing pin-on-disc equipment,³ which is a non-standard wear testing equipment based on the

Tampere Wear Center, Department of Materials Science, Tampere University of Technology, PO Box 589, FI-33101 Tampere, Finland

*Correspondence author, email vuokko.heino@tut.fi

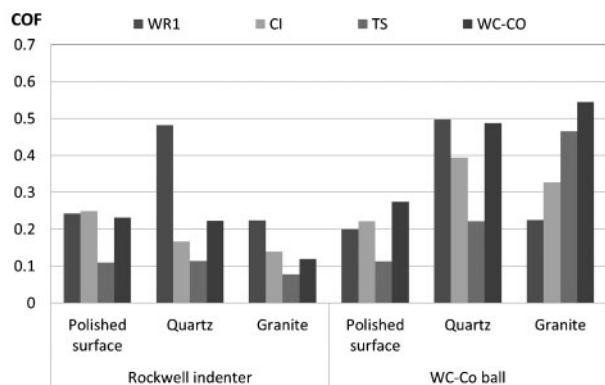

1 Results from scratch tests with normal load of 50 N

common pin-on-disc principle with the addition of loose abrasives. The disc is rotating at 28 rev min⁻¹ and the pin is pressed down to crush the abrasives. The compressive force used in the current tests was 240 N. The system is adjusted so that the pin (Ø36 mm) and the structural steel disc (Ø160 mm) are not in a direct contact with each other. The abrasives (500 g) form a rock bed on the disc. The wear surface of the pin is 1000 mm² and the pin is considered as specimen in further tests. The used abrasives were granite from Sorila quarry and quartzite from Haluna quarry. Quartzite is excavated from metamorphic rock. Both quarries are located in Finland. The size fraction of the abrasives was 2–4 mm.

Results

In this study, four different materials were scratch tested with different loads, indenters and surface characteristics. The loads were 50 and 100 N for both the Rockwell and the WC-Co indenter.

Three surface states were tested: the initial unworn polished surface and the two wear surfaces after crushing pin-on-disc tests with granite or quartzite abrasives. Altogether 48 tests were conducted and wear surfaces characterised. It should be noted that the coefficient of friction (COF) values discussed in the following include both the adhesion and ploughing terms of the lateral force.

Friction values

Figure 1 presents the results from the scratch tests with a 50 N normal load as average values of the coefficient of friction (COF). The results are grouped according to the used indenter and the state of the surface. The Rockwell indenter produced much lower values for the coefficient of friction of the wear surfaces. For the wear resistant steel (WR1) the behaviour was, however, similar with both indenters. The surface of WR1 after a wear test with quartzite produced significantly higher COF values than the polished surface and the surface after a wear test with granite.

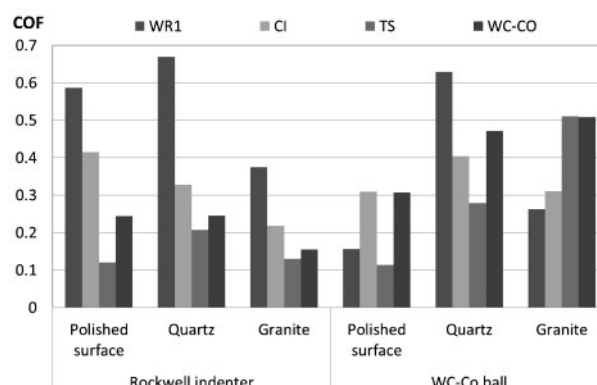

2 Results from scratch tests with normal load of 100 N

When looking at the COF values for the cast iron (CI), it can be noted that the behaviour changes with the indenter used. With the Rockwell indenter, the polished surface yields the highest COF. The surfaces after the wear tests have much lower COF values than the polished CI surface. The granite tested surface shows the lowest COF with the Rockwell indenter, but with the WC-Co indenter the highest COF value was recorded for the quartzite tested surface.

For the tool steel (TS) against the Rockwell indenter, the COF values are at a low level and there are only minor differences between the different surfaces. With the WC-Co indenter, the friction is clearly highest for the granite tested surface, almost five times higher than that for the polished surface.

With the Rockwell indenter, the polished surface and the surface after the wear test with quartzite show similar values for the WC-Co hard metal. The COF values of the surface after the wear tests with granite were the lowest, almost half of the values measured for the other WC-Co surfaces. The WC-Co indenter against the WC-Co surface behaved differently. The granite wear surface yielded the highest value while the lowest values were received against the polished surface.

Figure 2 presents the results of the scratch tests with a 100 N normal load as values of the coefficient of friction (COF). In these tests, the highest friction values were obtained with the Rockwell indenter against the wear resistant steel (WR1) surface after a wear test with quartzite. With the WC-Co indenter the highest friction values were obtained for the wear resistant steel (WR1) after a wear test with quartzite. With the Rockwell indenter the friction values for the cast iron (CI) specimen were the highest for the polished surface and the lowest for the granite tested surface. With the WC-Co indenter, the polished and granite tested cast iron (CI) surfaces showed the lowest COF values, and thus the highest value was measured for the quartzite tested surface. The tool steel (TS) showed the lowest friction values with the both indenters for the polished surface. The highest value for tool steel (TS) specimen with the

Table 1 Nominal compositions and measured hardnesses of tested materials

Specimen	Material	Nominal composition	Hardness/(HV10)
WR1	Wear Resistant Steel	0.14 wt-%C	360
CI	Cast Iron	3 wt-%C, 28 wt-%Cr	580
TS	Tool Steel	2.9 wt-%C	720
WC-Co	Hard Metal	15 wt-%Co	1210

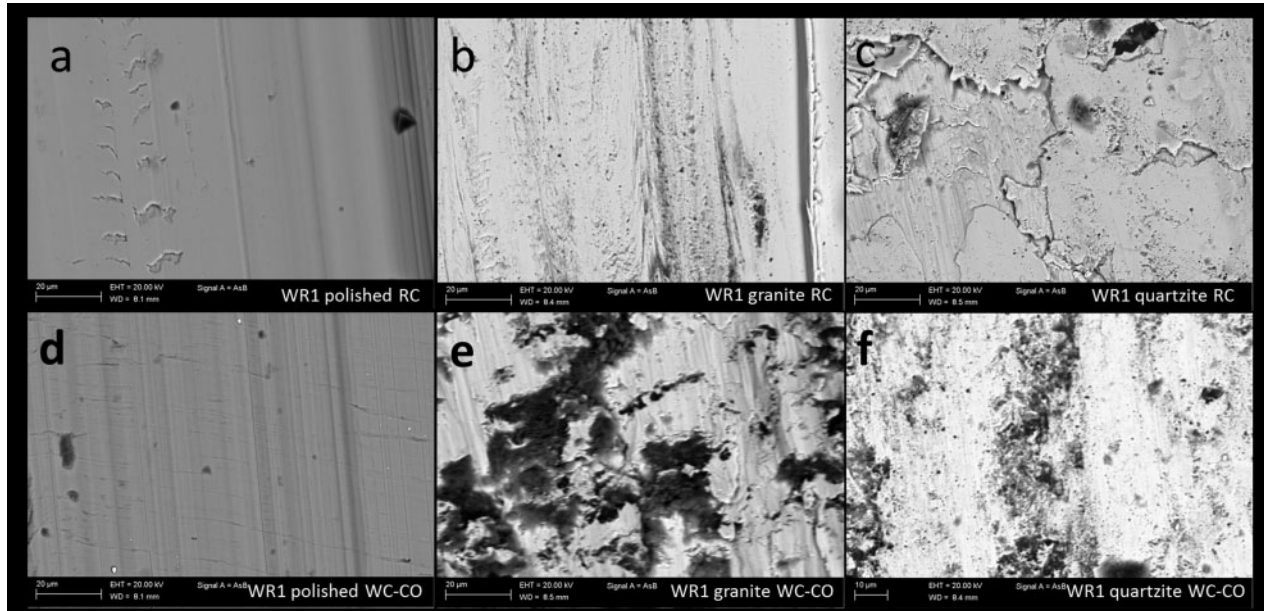

3 Images (SEM) from scratch test tracks of wear resistant steel (WR1) specimens with *a-c* Rockwell indenter and with *d-f* WC-Co ball

Rockwell indenter was obtained with the surface after the wear test with quartzite abrasives. With the WC-Co indenter, the granite tested surface gave the highest value. The WC-Co hard metal specimen tested with the WC-Co indenter gave the highest COF values with the surface wear tested with granite. The quartzite tested surface showed a slightly lower value. With the Rockwell indenter the surface after the wear test with granite yielded the lowest COF values, while the values for the polished surface and the surface after the wear test with quartzite abrasives showed quite similar values. The WC-Co indenter produced higher COF values for the WC-Co hard metal than the Rockwell indenter.

Surface characterisation

The produced scratches were characterised with a scanning electron microscope. The sharp Rockwell indenter produced quite well recognisable tracks even on the wear surfaces. The WC-Co ball, instead, produced much shallower tracks, which were quite hard to detect among the wear scars. Among the wear surfaces, the ones produced with quartzite abrasives had a more uniform appearance. Moreover, the small quartzite particles were embedded in the surface.

Figure 3 presents the wear tracks in the WR1 specimens produced with the normal load of 100 N using both indenters. The images are backscattered SEM images, showing elemental contrast. Thus heavier elements appear lighter and lighter elements, such as oxides in minerals, darker. The COF values recorded for the wear resistant steel (WR1) specimens showed the highest values with the quartzite tested wear surface with the Rockwell indenter and the lowest value with the granite tested wear surface with the WC-Co ball. The appearance of the scratch test track differs quite radically between the states of the surfaces. The Rockwell scratched granite wear surface (Fig. 3a) and the polished surface with the Rockwell indenter (Fig. 3b) has cracks in the scratch test tracks. There was some plastic deformation and minor parallel scratches in the polished specimen scratched with the WC-Co ball

(Fig. 3d). In the granite tested wear surface the WC-Co ball has slid over the abrasive residue on the wear surface; Fig. 3e illustrates that there is abundantly granite residues on the wear surface. On the wear surface produced by the quartzite tests the near surface regions have been affected by the embedded quartzite, leading to tearing of the surface by the Rockwell indenter. The effect of high friction can be seen from the scratch test track, which looks as if the movement of the indenter was more severely restricted by the surface structure. Similar behaviour can be seen on the quartzite wear tested surface with the WC-Co ball although in smaller scale and with excess quartzite residues on the scratch test track.

In the cast iron (CI) samples, the granite tested wear surface scratched by the Rockwell indenter had very clean and clearly cut appearance whereas the WC-Co ball produced wavy-like structure caused by the stress release during the movement of WC-Co ball. The quartzite tested wear surfaces resulted in high COF values with both the indenter and the ball. The quartzite residue content on the wear surfaces was much higher compared to granite with both indenters as seen in Fig. 4a and b. Moreover, there was no evident tearing of the surface, as in the case of WR1. Therefore, the formed quartzite layer is well attached to the cast iron surface.

Figure 5 shows that some carbides are present in the microstructure of the tool steel. After scratching with the WC-Co indenter, there are also some hard metal residues on the surface. This is because the WC-Co ball was scratched by the hard vanadium carbides on the surface. Cracking was not observed under the WC-Co indenter, but slight plastic deformation could be detected. After scratching the polished sample with the Rockwell indenter, also crushed carbides and some plastic deformation was observed on the surfaces. In the granite wear surface the scratch produced by the Rockwell indenter is deeper and the bottom of the scratch is quite clear from the abrasive residues. Angular cracks can be seen in the bottom of the scratch, where

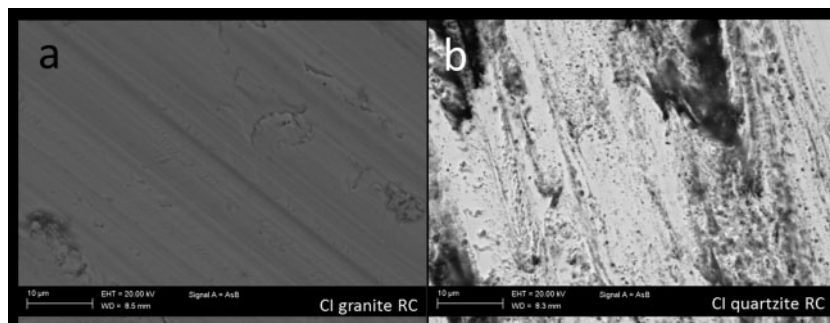

4 Images (SEM) from scratch test tracks of cast iron (CI) specimens with *a* Rockwell indenter on granite and *b* quartzite wear surfaces

the indenter has to some extent crushed the carbides. In contrast to the above, the WC-Co indenter seems to have practically flown over the deformed surface and the abrasive residue piles. WC-Co residues were found in these piles. The carbides were surrounded by shear tongues formed by the sliding indenter. The appearance of the quartzite wear surfaces of the tool steel samples after the Rockwell indenter test was not as highly deformed as the surface initially worn with granite. Angular cracks were found on the surface, and abrasive residues were present but not as much piled as in the case of granite abrasives. Small quartzite abrasives and crushed carbides were found in the bottom of the scratch, where the WC-Co indenter had embedded them. The indenter had not markedly deformed the surface but rather slid over the wear surface irregularities and smoothed the highest peaks.

In all the WC-Co specimens, the extrusion of cobalt binder and the re-embedding of crushed carbides were evident as seen in Fig. 6. In the granite tested wear surfaces scratched by the Rockwell indenter, the crushed granite filled partially the places of removal binder. Scars, crushed carbides and small abrasive residue piles were found on the tracks produced by the WC-Co ball.

A laser profilometer was used to obtain information about the surface roughness and the depth of the

tribometer tracks. It was observed that the depth of the track was much higher in the wear surfaces than in the polished one. In the polished surface of the softest material WR1 the depth of the Rockwell indenter scratch with a 100 N normal load was 15 µm. Other specimens had higher hardness and therefore the depths of the Rockwell scratch test tracks were in the range of 1.5–2.5 µm depending on the hardness. Higher load increased the track depth, as could be expected for a sharp indenter. For example, increasing the load from 50 to 100 N increased the scratch depth from 0.2 to 15 µm in the case of WR1. This difference, however, decreased with increasing material hardness so much that it was hard to distinguish the roughness from the wear tests and the tribometre tracks.

Discussion

In this study, three different states of the surfaces in four different materials were scratch tested in order to characterise their properties in dry sliding. The tested surfaces were earlier subjected to crushing pin-on-disc wear tests with granite and quartzite as abrasives. As a reference, a polished specimen of each test material was used. The selection of the test materials was based on the previous studies of the effect of quartzite abrasive

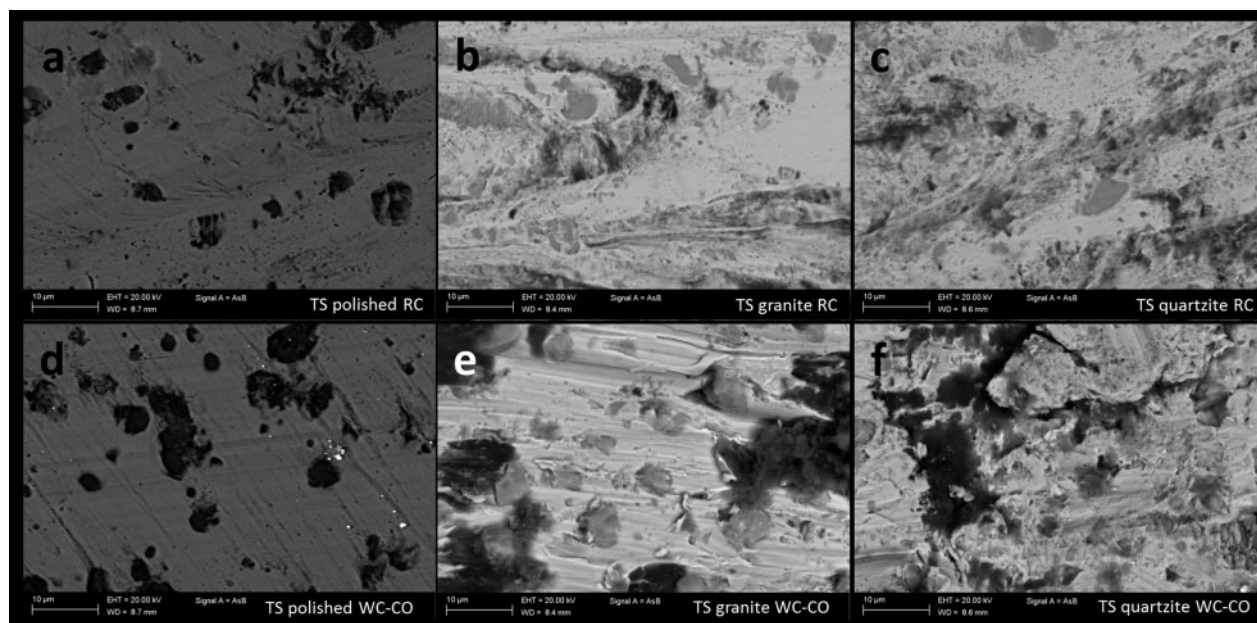

5 Images (SEM) from scratch test tracks of tool steel (TS) specimens with *a–c* Rockwell indenter and with *d–f* WC-Co ball

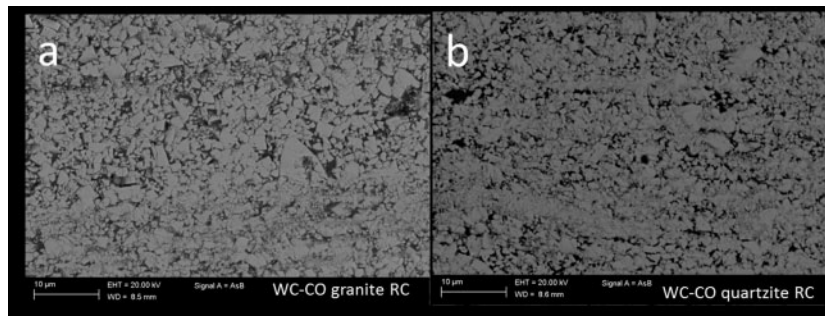

6 Images (SEM) from wear tracks of WC-Co specimens with *a* Rockwell indenter on granite and *b* quartzite wear surfaces

embedding on the wear properties of various materials.² It was stated that the *in situ* quartzite composite lowers the wear rate in certain tests.⁴ Further studies showed that steels with hardness below 400 HV are not hard/strong enough substrates for this kind of composite layer, peeling off this layer increased the mass loss during the test.² These same materials were now studied with the scratch tests.

The state of the surface had a clear effect on the scratch test results. The abrasives have different properties and this is also reflected on the properties of the wear surfaces. Granite has higher compressive strength, and therefore it is not as effectively crushed into fine particles as quartzite. Furthermore, the prevailing fracture mechanism in granite is cleavage fracture, while in quartzite it is conchoidal.⁵ Therefore, the quartzite particles with sharp angular features can more easily be mechanically mixed with the specimen surface during the wear tests. The surface hardness of the substrate, of course, needs to be lower than that of quartzite. Granite remains in larger particles, which are generally crushed more locally resulting in piles of abrasive residuals rather than uniformly distributed over the wear surface.

In the case of quartzite, the wear surface acted as a coating. Cracks were found at the bottom of the track, and in some cases also delamination occurred. This was seen especially in the case of wear resistant steel; the results showed similar frictional values for the quartzite tested surface with both indenters and both normal forces. The features of the track bottoms in the granite wear tested and polished surfaces were similar.

The indenter geometry also affected the results as reported by Mezlini *et al.*⁶ In the polished surfaces, the Rockwell indenter resulted in higher frictional forces, which is quite expected since it has a smaller contact area and therefore also a higher contact pressure than the hard metal ball indenter. In the wear surfaces the effect is quite the opposite compared to the polished surfaces. While the contact area is smaller with the Rockwell indenter, also the probability for the indenter to collide with abrasive residuals and surface roughness is lower. This leads to lower frictional forces than with the WC-Co indenter, which will experience more interaction with abrasive residuals and surface roughness leading to higher frictional forces.

The microstructures had also an effect on the results. WC-Co consists of a carbide skeleton embedded in cobalt binder. Under the point-like Rockwell slider, the

carbides are easily crushed and the cobalt binder becomes to some extent extruded. Crushed carbides can also become re-embedded into the surface.⁷ The increased load had no effect on the COF values of the polished and quartzite abraded surfaces, but there was a slight increase in the COF value of the granite abraded surface. The tool steel (TS) specimen has vanadium carbides in a steel matrix, and it was noted that the carbides were protruded from the matrix and caused high COF values. This effect was stronger with granite abraded wear surfaces.

Conclusion

In this study, different states of sample surfaces were scratch tested in order to characterize their tribological properties. The surfaces of four materials were first wear tested with granite and quartzite abrasives using the crushing pin-on-disc method. A polished unworn sample surface was used as a reference.

The results indicate that the quartzite abraded surfaces result in higher frictional forces and COF values than the granite abraded surfaces and the polished ones. Therefore we can conclude, based on these and our earlier findings, that embedded quartzite in the sample surface increases friction and affects the further wear rate of certain materials.

References

1. C. S. C. Davison: 'Wear prevention in early history', *Wear*, 1957, **1**, 155–159.
2. V. Heino, K. Valtonen, P. Kivikytö-Reponen, P. Siitonen and V-T. Kuokkala: 'Characterization of the effects of embedded quartz layer on wear rates in abrasive wear', Proc.15th Nordic Symp. on 'Tribology Nordtrib 2012', Trondheim, Norway, June 2012, NTNU, Paper 46.
3. J. Terva, T. Teeri, V-T. Kuokkala, P. Siitonen and J. Liimatainen: 'Abrasive wear of steel against gravel with different rock-steel combinations', *Wear*, 2009, **267**, 1821–1831.
4. V. Heino, P. Kivikytö-Reponen, M. Vippola, K. Valtonen and V-T. Kuokkala: 'Wear reducing effect of embedded quartz abrasives in the crushing-pin-on-disc test method', *Tribol. Online*, 2012, **7**, (3), 179–183.
5. R. Selley, R. Cocks and R. Plimer (eds.): 'Encyclopedia of geology'; 2005, Amsterdam, Elsevier.
6. S. Mezlini, P. Kapsa, J. C. Abry, C. Henon and J. Guilleminet: 'Effect of the indenter geometry and relationship between abrasive wear and hardness in early stage of repetitive sliding', *Wear*, 2006, **260**, 412–421.
7. I. M. Hutchings: 'Tribology: friction and wear of engineering materials'; 1992, London, Edward Arnold.

Publication V

Vuokko Heino, Marke Kallio, Kati Valtonen and Veli-Tapani Kuokkala

The role of microstructure on the high-stress abrasion of white cast irons

Wear 388-389 (2017) 119-125

©2017 Elsevier B. V.

Reprinted with permission

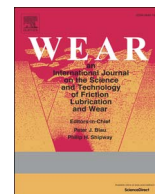

The role of microstructure in high stress abrasion of white cast irons



V. Heino^{a,*}, M. Kallio^b, K. Valtonen^a, V.-T. Kuokkala^a

^a Tampere University of Technology, Tampere Wear Center, Department of Materials Science, P.O. Box 589, FI-33101 Tampere, Finland

^b Metso Minerals Oy, P.O. Box 306, FI-33101 Tampere, Finland

ARTICLE INFO

Keywords:

cast iron
three-body abrasion
wear testing
mining
mineral processing

ABSTRACT

The abrasion wear resistance of white cast irons can be controlled primarily by adjusting the size, size distribution, and volume fraction of the carbide phase. The main physical property of white cast irons correlating with abrasion resistance is hardness. This study concentrates on the evaluation of hardened and stress relieved, normalized, self-hardened, and as-cast states of high chromium white cast irons in high stress abrasion. The correct size and orientation of the carbides were found to be crucial for the wear resistance of white cast irons in high stress abrasive conditions. The different annealing procedures affected the formation of the carbide structure and its distribution, as well as the microstructure of the matrix. The austenite-to-martensite ratio together with a beneficial carbide structure was found to have a strong effect on the abrasion wear resistance of WCI specimens.

1. Introduction

White cast irons (WCI) are considered one of the earliest wear resistant materials. Despite the long history of white cast irons, they are of continuing interest due to the wide variety of different compositional features combined with a relatively low production cost. The effects of different fractions of the carbide phase and the microstructures of the matrix on abrasive wear have been extensively studied [1–5].

The abrasion wear resistance of white cast irons can be altered by adjusting the carbide phase properties. The relative hardness and toughness of the matrix phase also play an important role in the abrasion wear resistance [6]. For optimal abrasion resistance, the microstructure and hardness of the white cast irons must be appropriate for the application. The required properties are obtained by careful control of the material composition and the processing route.

The carbide orientation has been found to be one of the main features affecting the abrasive wear performance of white cast irons [7,8]. Hawk et al. [9] found that when the carbides were oriented with their long axis perpendicular to the wear surface, the abrasion resistance was considerably reduced. The best wear performance was achieved when the long axis of the carbides was parallel to the wear surface and perpendicular to the wear (load) direction. According to Coronado et al. [10], however, at lower loads the mass loss was independent of the orientation of the carbides with respect to the wear direction, and only at higher loads the carbide orientation perpendicular to the direction of wear led to better abrasive wear performance.

Steel and WC-Co specimens have been studied earlier with the same

test method as used in the present study [11], and the results show that the wear rate of these materials is hugely affected by the abrasive properties. Granite with quite a high compressive strength would probably lead more to the cracking of carbides, while quartz with a much lower compressive strength would most likely lead more to the removal of the matrix phase and pull-out of carbides. Despite the large number of papers published on the abrasion wear resistance of white cast irons, the wear performance of WCI's in different annealing conditions has not been much studied nor reported. This study concentrates on the effects of different heat treatments on the high stress abrasion behavior of high chromium white cast irons. The four studied conditions are hardened and stress relieved, normalized, self-hardened, and as-cast.

2. Materials and methods

High chromium white cast irons of similar composition were tested in high stress abrasion in hardened and stress-relieved (H), normalized (N), self-hardened (ACSH), and as-cast states (AC). The studied high chromium abrasion resistant cast irons belong to the highest chromium content group EN-GJN-HB555(XCr23) of EN-12513 with 23 wt.% < Cr ≤ 30 wt.%. They typically have a microstructure consisting of complex carbides in a matrix which, in the hardened condition, is predominantly martensitic but can also contain some austenite or other transformation products of austenite.

* Corresponding author.

E-mail address: vuokko.heino@tut.fi (V. Heino).

Table 1
Nominal compositions (wt%) of the studied castings.

Casting	C %	Si%	Mn%	P %	S %	Cr %	Ni %	Mo%	Cu %	Al %	N %	V %
WCI 1	2.9	0.82	0.8	0.028	0.018	28.2	0.62	0.15	0.08	0.002	0.094	0.056
WCI 2	2.94	0.94	0.7	0.028	0.027	27.1	0.71	0.61	0.58	0.002	0.12	0.049

2.1. Materials

The nominal compositions of the alloys are presented in Table 1. Casting WCI 2 had a higher amount of copper (Cu) and molybdenum (Mo).

Hardening of the casting involves slow heating up to a pre-defined temperature range (in this work 900 °C to 1050 °C), holding there for a time appropriate for its thickness and chemical composition, and rapid cooling. Only simple shaped castings can be oil quenched without the risk of cracking, and therefore rapid cooling is most frequently done using air/gas cooling. The air/gas cooling can be carried out by fan cooling, forced gas, or atomized liquid spray techniques. It can be necessary to cool complex shaped castings in still air. In such circumstances it is important that the material's chemical composition makes provision for sufficient hardenability. Stress relieving consists of slow heating up to the temperature range of 400 °C to 500 °C, holding for a sufficient time and slowly cooling down with the furnace to about 200 °C. Normalizing consists of heating as in hardening, but with slow cooling down to RT with the furnace.

The cooling rate will determine the resulting microstructure and hardness of the high chromium abrasion resistant cast irons. In this study, the cooling rate was varied according to the different casting wall thickness. Table 2 summarizes the studied white cast irons, their heat treatment states, and the measured hardness values.

2.2. Materials properties

Bulk hardness values were measured with Struers Duramin A-300 hardness tester and the micro hardness values with a SEM-integrated micro hardness tester Anton Paar. Structural analyses were done with Panalytical Empyrean Multipurpose Diffractometer (XRD) and are presented in Fig. 1.

Fig. 2 presents the microstructures of the studied materials below the wear surface, characterized with the Philips XL30 scanning electron microscope (SEM). AC, N and ACSH have an oriented structure with long carbides, whereas the H specimen has a non-uniform structure with different shapes of carbides. The densest carbide structure was found in the ACSH specimen. The longest mean free path was observed in the microstructure of the N specimen.

2.3. Crushing pin-on-disc test

High stress abrasion tests were conducted with the crushing pin-on-disc device. It is based on the common pin-on-disc principle with the addition of loose abrasive particles and a cyclic crushing stage [11]. All

Table 2
Heat treatments and hardness values of the tested white cast irons.

Heat treatment state	as-cast, slow cooling rate	as-cast, fast cooling rate	hardened and stress relieved	normalized
Specimen code	AC	AC SH	H	N
Casting	WCI 1	WCI 2	WCI 2	WCI 2
Bulk Hardness (HV10)	351	702	740	718
Matrix hardness (HV0.1)	320	597	702	740
Carbide hardness (HV0.1)	~1700	~1700	~1700	~1700

the specimens were subjected to a pre-wear period of 15 minutes with 2–4 mm size of abrasive. During this stage the wear surface achieves the steady state of wear. The actual wear test was 30 minutes long with 2–10 mm granite abrasive (from Sorila quarry in Finland), and the results are presented as the median values of three tests. One test includes 20 minutes of crushing action and 10 minutes of idle time with the specimen pin being lifted above the gravel bed. The hardness of the Sorila granite was ca. 800HV, and the rock consisted of the following minerals in the order of decreasing volume fraction; plagioclase, quartz, orthoclase, biotite and amphibole. The selected granite is a very hard and abrasive mineral with high compressive strength.

Fig. 3 presents the construction of the test device. The pin (WCI specimen) had a diameter of 36 mm and height of 35 mm. The disc (160 mm in diameter) used in these tests was made of structural steel (200 HV5). The disc rotates at 28 RPM, and the pin is cyclically pressed with a 240 N force towards the disc. The disc and the pin never make a direct contact with each other due to the layer of abrasives being crushed between them. The crushing cycle consist of two phases. The pin crushes abrasives for two rotations (5 s), after which the pin is lifted up for one rotation (2.5 s) and then pressed again down to the pile of abrasives for a new cycle. This cycle ensures that there is always a sufficient amount of abrasives between the pin and the disc. The wear surfaces and cross-sections were characterized using SEM. Wear surfaces were also characterized with optical profilometer Alicona InfiniteFocus G5 3D.

3. Results and discussion

WCI specimens in each of the four annealing conditions were tested with the crushing pin-on-disc. Each specimen was tested three times. Fig. 4 presents the results as median mass loss together with the bulk hardness values. The results were scaled to the wear area of 1000 mm² in order to obtain as reliable and comparable results as possible. The highest mass loss was measured for the AC specimen, as could be expected from its low hardness. The H and ACSH specimens were at quite the same level of mass loss. The scatter in the results of H specimens was very low. However, it is worth mentioning that the wear rate of the ACSH specimen decreased after each 30 minutes of testing, which explains the slightly increased standard deviation of the test runs on this specimen. Actually, the lowest wear rate was observed in the last test run of the ACSH specimen. Due to the fact that the median values were used to present the overall wear of the specimens, it seems that the H specimen reached the lowest values. The N specimen had a higher wear rate than specimen H with quite similar matrix hardness.

The surface of the lowest hardness specimen AC had deformed most during the wear test. Deep and wide scratches were present, and the wear surface appeared to contain quite few abrasive residues due to the constant material removal. The low hardness matrix had not been able to withstand the contact pressure caused by the abrasive particles sliding on the surface, and thus the carbides were crushed. The crushed carbides had also been participating in the actual wear process together with the granite abrasives. Fig. 5 presents micrographs from the typical wear process of the AC specimen: it is obvious that the matrix has deformed below the wear surface, which has caused crushing of the carbides even deeper inside the material, down to 50 μm below the surface. When these long, crushed carbides have opened to the wear surface, the crushed carbide material has been removed by the deformation movement of the matrix and the carbides have been

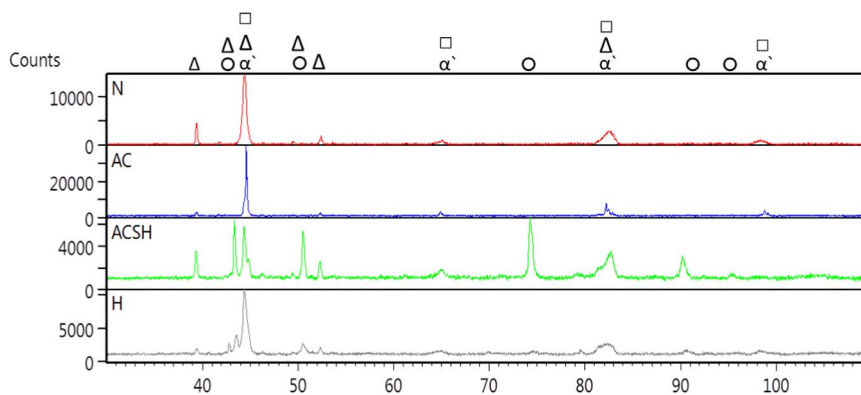

Fig. 1. XRD structural analysis of the studied materials; Δ denotes Cr₇C₃ carbides, □ ferrite matrix, ○ austenite matrix and α' martensitic matrix.

substituted by the penetrating abrasives. This has increased the wear rate by acting as a wedge spalling off the material.

The N specimen contained a higher amount of abrasive residues on the wear surface due to the higher hardness matrix with low level of cutting. Due to higher hardness, also the deformation depth of the wear surface was lower, resulting in a smoother surface than in the AC specimens. Scratches were more superficial and some of the crushed carbides were removed and partially replaced by the crushed granite particles, but only near the surface region. Fig. 6 shows the cross-section from the wear surface of the N specimens. The higher hardness matrix was supporting the carbides better and the carbides were not as effectively crushed as in the AC specimens, but the carbides had cracks mostly parallel to the wear surface. The support of the tougher matrix caused the cracked carbides opened into the surface to remain in place and not to become replaced by the crushed granite abrasives. The wedge effect was also observed but not in a similar way as in the AC

specimens. The wedge was formed under the carbide through the matrix, as seen in Fig. 5B. Fatigue cracks were observed in the wear surface of the matrix side of the N specimen.

The wear surface of the H specimens contained similar features as the N specimens. The amount of abrasive residues on the wear surface was at the same level. Cracking of the carbides was observed ~20 μm from the wear surface. The deformation depth was quite similar to the N specimens. Wide superficial scratches were found, and cracking of the carbides was observed on the wear surface as well. However, it was noted that the hardness of the matrix was quite optimal for supporting even cracked carbides opening to the wear surface, as can be seen from Fig. 7. Most of the wear has taken place in the matrix, and the small carbides parallel to wear surface have been detached from the matrix. A few fatigue cracks were also observed in the matrix beneath the wear surface.

In the ACSH specimen, the wear surfaces were quite similar to the N

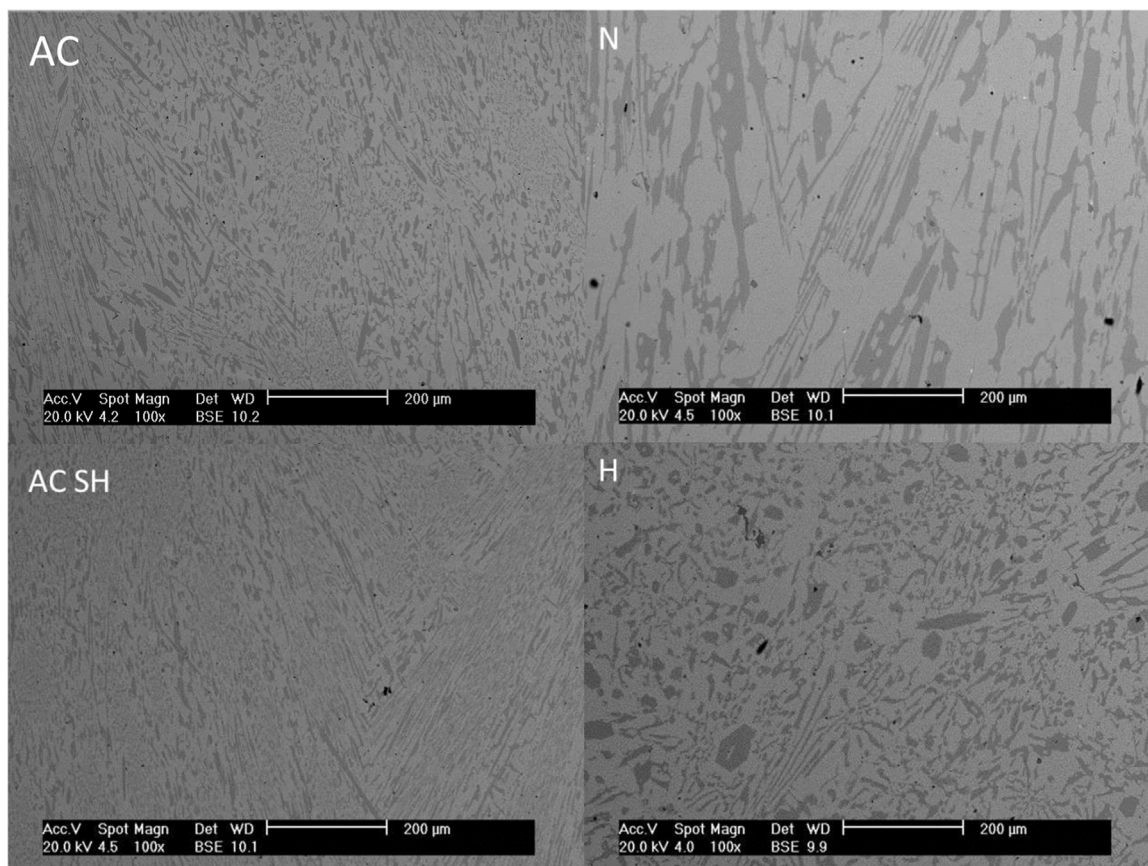

Fig. 2. SEM images of the microstructures of the studied white cast iron specimens.

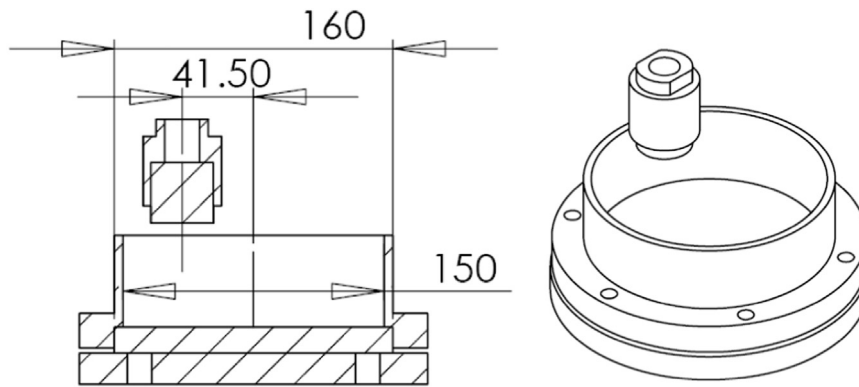

Fig. 3. Schematic illustration of the crushing pin on disc test device [11].

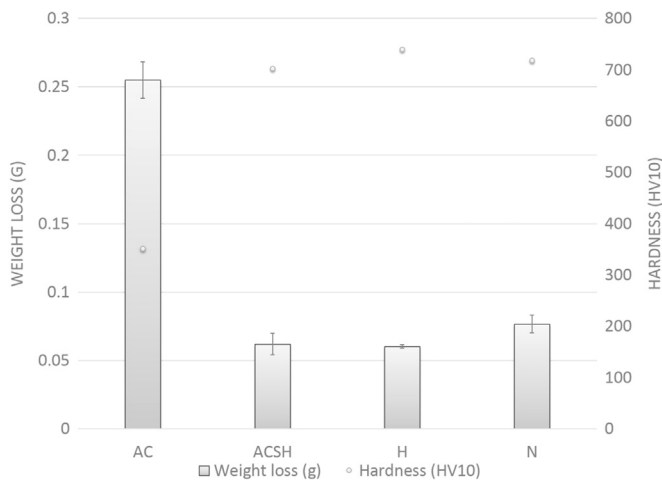

Fig. 4. Results of the crushing pin on disc tests with bulk hardness values.

and H specimens with similar bulk hardness. The level of the crushed abrasives was also similar, and the scratches were quite superficial. The ACSH specimen had the densest structure of carbides of these three harder specimens. The carbide structure consists of small carbides oriented towards the wear surface, as seen in Fig. 8. The smaller size of the carbides enables them to slightly re-orientate when the matrix is deformed. Cracking of the carbides was occasional beneath the wear surface.

The orientation, shape, and size of the carbides had a clear effect on the wear process. Small size spherical carbides near the wear surface were easily removed from the matrix during the plastic deformation caused by abrasives, as was observed with the AC specimen with a quite

heterogeneous structure. The performance of small longitudinal carbides was depending also on their orientation. When carbides were oriented parallel to the wear surface, high stresses were concentrated in the boundary area between the matrix and the carbide. On that occasion, the carbides cracked and also the interface between the carbide and matrix was subjected to high stresses leading into loosening of the carbide.

Hardness profiles were measured from the worn surfaces. In addition to hardness values, the measurements provided information about the material's response to point-like loads. In the utilized wear test method, the basic idea is to compress the rock bed between the specimen and the disc. Before anything is actually crushed, there are point-like contacts between the rock particles and the specimen surface. Based on the hardness profile data presented in Fig. 9, the different behavior of the matrix and the carbide phase can be estimated. The ACSH specimen gives very uniform hardness values under the 1 kg load. This means that the response to the load comes quite equally from both phases. The other specimens showed more fluctuating values, which means that either the matrix or the carbide phase was occasionally affecting more the obtained hardness value. The bulk hardness of the three hardest specimens was at the similar level as shown in Table 2. These values were measured with the Vickers indenter and the load of 10 kg. In the crushing pin-on-disc method the actual contact area of the rock bed is initially ~2% of the apparent contact area. Towards the end of the test, the actual contact area increases with decreasing abrasive size to ~4% of the apparent contact area, as measured with pressure sensitive paper. This means that the actual load per square millimeter was 1.2 kg at the very beginning of the test which quite closely corresponds to the Vickers measurements with a 1 kg load.

Although the studied white cast irons had different types of carbide structures, the volume fractions of the carbide phases were at a similar

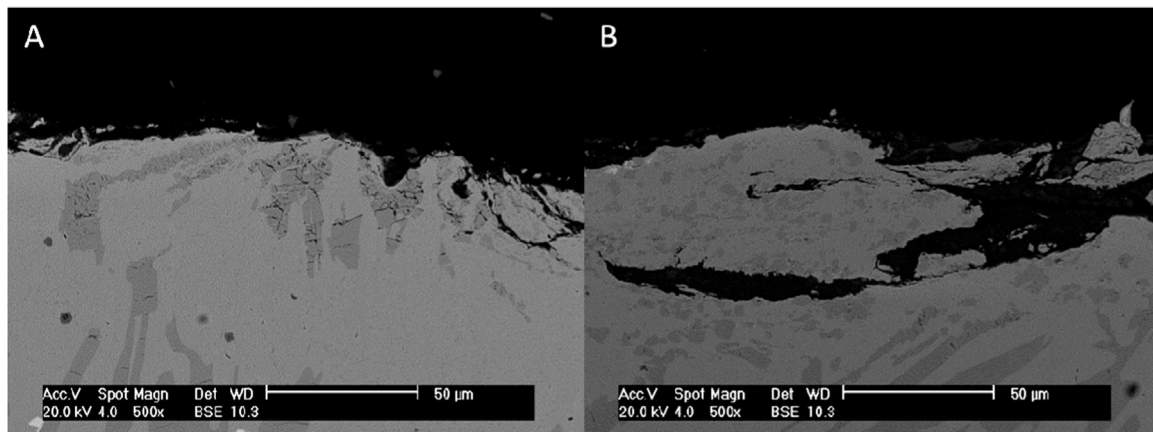

Fig. 5. Cross-section of the AC wear surface with crushed carbides (A) and crushed long carbide replaced by crushed granite (B).

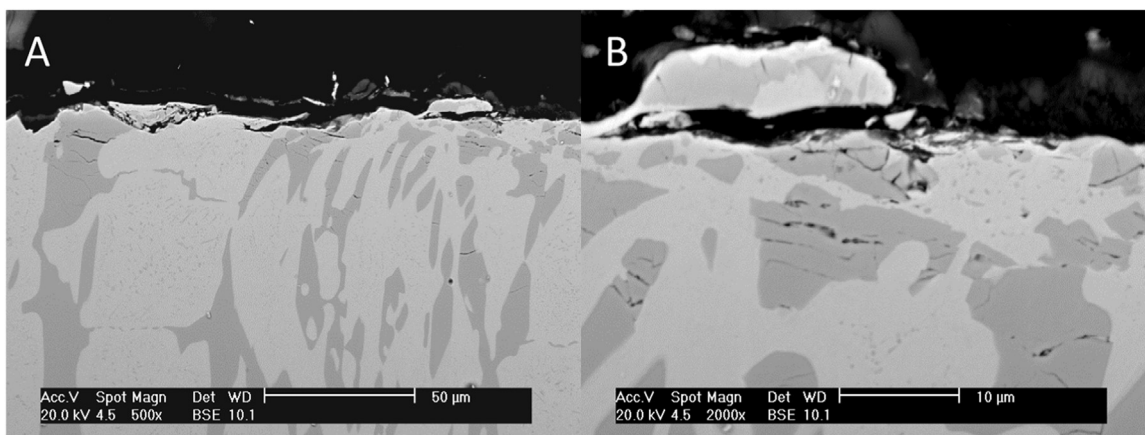

Fig. 6. Cross-section of the N wear surface with cracked carbides (A) and a wedge formed under a carbide by crushed granite particles (B).

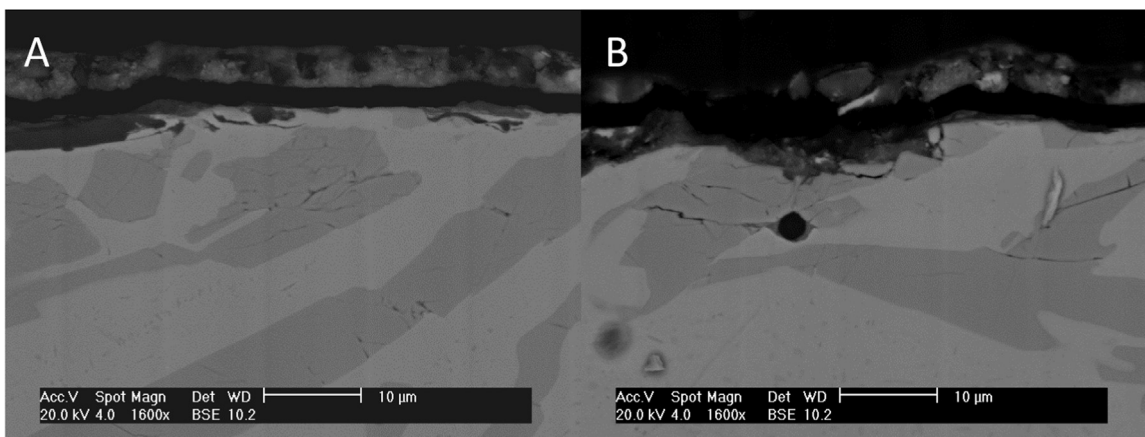

Fig. 7. Cross-section of the H wear surface with cracked carbides (A) and a carbide open to the wear surface (B).

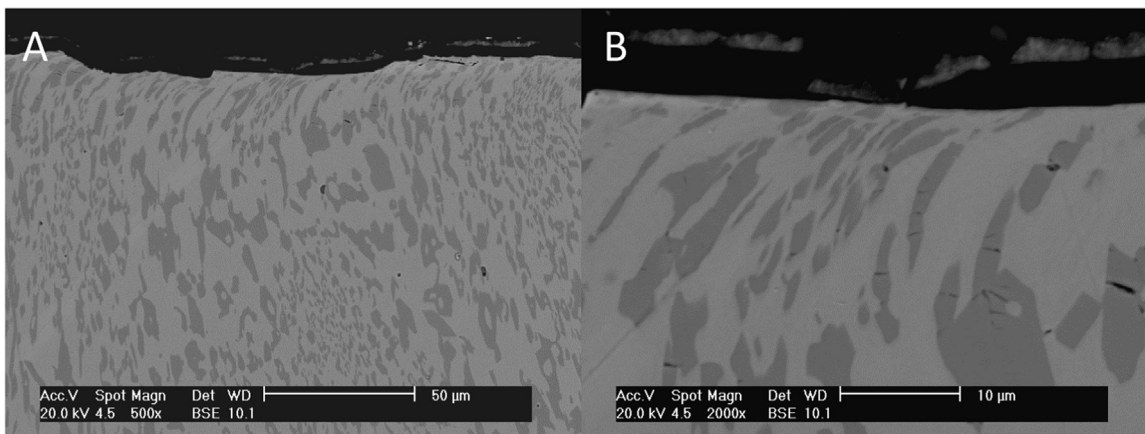

Fig. 8. Cross-section of the ACSH wear surface with carbides deformed in the wear direction (A) and a carbide cracking near the wear surface (B).

level (~30 vol.%), as could be expected from the quite similar elemental compositions. This was verified by image analysis on SEM images. The image analysis results of the as-cast specimens showed higher scatter compared to the other materials, which suggests uneven distribution of the carbides. Uneven distribution of carbides was also seen as a relatively high scatter of the wear test results of the AC specimens.

High hardness is the key property for good abrasion wear resistance together with a sufficient level of toughness. The studied white cast irons possess both of these properties but in different phases; high hardness and brittleness in the carbide phase, and toughness in the

ferrous matrix. All studied specimens had Cr_7C_3 carbides in their microstructure, but their sizes and orientations differed. The as-cast specimens had the lowest bulk hardness and the lowest matrix hardness, which points to the presence of ferrite in the microstructure. This was also verified by the XRD measurements. Ferrite in the matrix was unable to properly support the carbide structure despite the carbide phase orientation, and the low hardness of the matrix enabled the deformation to reach the carbides and to crush them due to their low compression strength. The crushed carbide zone was found to extend from the surface down to ~50 μm beneath the surface. Cracked carbides were found even as deep as ~100 μm from the surface. In

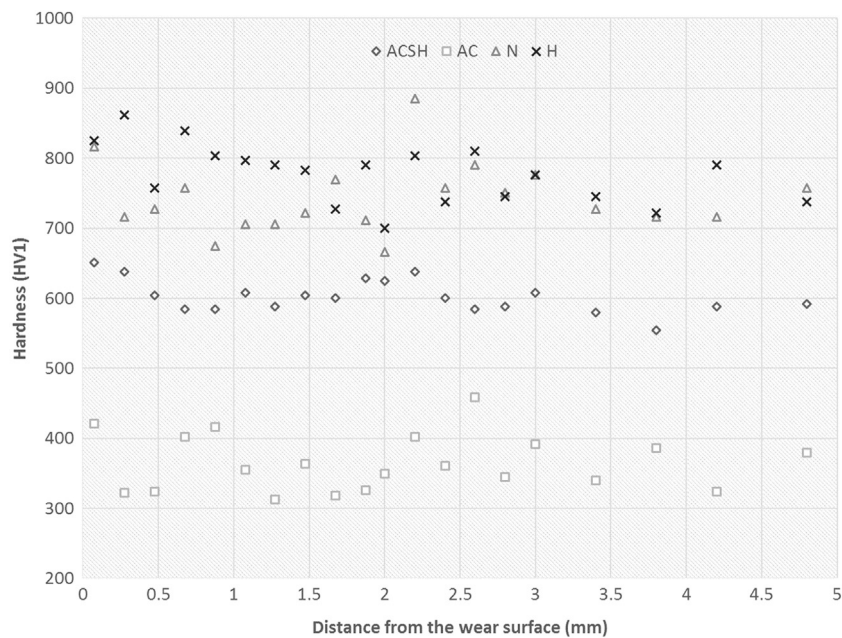

Fig. 9. Hardness profiles from the cross-sectional specimens (1st indentation 75 μ m from the wear surface).

the cases when the carbides are oriented relative to the surface at some low angle (not parallel or perpendicular), the crushed carbide can open to the surface and the actual carbide phase be replaced by the abrasive particles during the wear process. Depending on the carbide network, this replacement can occur for quite long distances and cause even higher material removal rates.

The bulk hardness values of the ACSH, H and N specimens were at a similar level, but the microhardness of the ACSH matrix was much lower. However, all materials showed quite similar wear rate levels. The matrix phase of the ACSH specimen was similar to the H specimen. They both contained austenite in addition to martensite in their matrix. The amount of austenite was higher in the ACSH specimen, which explains the difference in the matrix hardness values. The matrix of the N specimen was fully martensitic. Considering the results obtained for test materials with different matrix phases, it can be stated that the fully martensitic matrix is not a beneficial matrix in the case of high stress abrasion, as the surface of the sample can easily suffer from fracturing, as seen in Fig. 6. The matrix of material H consists mainly of martensite with traces of residual austenite, leading to the presence of surface fractures. Doğan et al. [12] have also reported better abrasion wear resistance for the mixture of austenite and martensite in the matrix.

Several studies have been conducted regarding the effect of carbide orientation on abrasion wear resistance. Some of them [13] suggest that it is more beneficial to have the long axis of the carbides parallel to the wear surface, while the others indicate that higher abrasion resistance can be obtained when the long axis is perpendicular to the wear surface. The results of this study suggest that a structure with long thin carbides forming columnar zones perpendicular to the wear surface is beneficial against abrasive wear. Such zones decrease the possibility of the abrasive particles to scratch the specimen surface for long distances. The mean free path between these zones is affected by the abrasive size, as indicated by the hardness profiles in Fig. 8. It was also observed that the long carbides were slightly bent towards the wear direction with the deformation of the matrix, and some of the crushed carbides were embedded in the surface layer.

Based on the current and previous studies related to the abrasion resistance of WCI's, it can be stated that the wear behavior under abrasive conditions is very case sensitive especially for materials with complex structures, such as white cast irons. The material itself affects the abrasion process through several microstructural and property parameters, and the actual test or application conditions provide their

own challenges. According to Albertin et al. [1], in laboratory ball mill experiments the abrasion wear resistance of white cast irons was also affected by the abrasives used in the tests. In this study, it was noted that the cracking behavior of carbides under high stress abrasion was dominated by the supporting action of the matrix as well as the orientation of carbides. In addition, with similar hardness level, small differences in microstructure can have a notable effect for wear resistance.

4. Conclusions

White cast iron specimens with different heat treatments were tested using the crushing pin-on-disc method in order to determine their high stress abrasion resistance. Based on these studies, the following conclusions can be made:

- The austenite-to-martensite ratio in the matrix phase affects the abrasion resistance. Too high martensite content easily leads to fracturing of the matrix in the surface region.
- The columnar structure of thin and long carbides oriented perpendicular to the wear surface was found to provide the best abrasion resistance in the crushing pin-on-disc tests with granite abrasive.
- Abrasion resistance of white cast irons is very case sensitive and depends greatly on the properties and microstructure of the material as well as on the wear conditions.

Acknowledgements

This work was done within the FIMECC BSA (Breakthrough Steels and Applications) Programme as part of the FIMECC Breakthrough Materials Doctoral School. We gratefully acknowledge the financial support from the Finnish Funding Agency for Innovation (Tekes) and the participating companies.

References

- [1] E. Albertin, A. Sinatora, Effect of carbide fraction and matrix microstructure on the wear of cast iron balls tested in a laboratory ball mill, *Wear* 250 (1–12) (2001) 492–501.
- [2] C. Çetinkaya, An investigation of the wear behaviours of white cast irons under different compositions, *Mater. Des.* 27 (6) (2006) 437–445.
- [3] J.J. Coronado, A. Sinatora, Abrasive wear study of white cast iron with different

- solidification rates, *Wear* 267 (11) (2009) 2116–2121.
- [4] Y. Li, Y. Gao, Three-body abrasive wear behavior of CC/high-Cr WCI composite and its interfacial characteristics, *Wear* 268 (3–4) (2010) 511–518.
- [5] G. Pintaude, A.P. Tschiptschin, D.K. Tanaka, A. Sinatora, The particle size effect on abrasive wear of high-chromium white cast iron mill balls, *Wear* 250 (1–12) (2001) 66–70.
- [6] J. Asensio, J.A. Pero-Sanz, J.I. Verdeja, Microstructure selection criteria for cast irons with more than 10 wt% chromium for wear applications, *Mater. Charact.* 49 (2) (2002) 83–93.
- [7] J.J. Coronado, A. Sinatora, Effect of abrasive size on wear of metallic materials and its relationship with microchips morphology and wear micromechanisms: part 1, *Wear* 271 (9–10) (2011) 1794–1803.
- [8] J.J. Coronado, A. Sinatora, Effect of abrasive size on wear of metallic materials and its relationship with microchips morphology and wear micromechanisms: part 2, *Wear* 271 (9–10) (2011) 1804–1812.
- [9] Ö.N. Doğan, J.A. Hawk, Effect of carbide orientation on abrasion of high Cr white cast iron, *Wear* 189 (1–2) (1995) 136–142.
- [10] J.J. Coronado, Effect of load and carbide orientation on abrasive wear resistance of white cast iron, *Wear* 270 (11–12) (2011) 823–827.
- [11] V. Ratia, V. Heino, K. Valtonen, M. Vippola, A. Kemppainen, P. Siitonen, V.-T. Kuokkala, Effect of abrasive properties on the high-stress three-body abrasion of steels and hard metals, *Tribologia* 32 (1) (2014) 3–18.
- [12] Ö.N. Doğan, G. Laird, J.A. Hawk, Abrasion resistance of the columnar zone in high Cr white cast irons, *Wear* (181–183) (1995) 342–349.
- [13] J.D. Gates, G.J. Gore, M.J.-P. Hermand, M.J.-P. Guerineau, P.B. Martin, J. Saad, The meaning of high stress abrasion and its application in white cast irons, *Wear* 263 (1–6) (2007) 6–35.

Tampereen teknillinen yliopisto
PL 527
33101 Tampere

Tampere University of Technology
P.O.B. 527
FI-33101 Tampere, Finland

ISBN 978-952-15-4205-3

ISSN 1459-2045